

eldsf

sf7df8f)pkTosfdf a9bf]zx/ls/of / hg; wofsf]rfknf0{dllogh/df /fvb}sf7df8f)nlntk/ gu/kflnsf lfq tyf sf7df8f)pkTosfsf]zx/ lj:tf/ lfq leq ul/g]lgdf0f ; DaGwl dfkb08, @)%)# nf0{ ; do ; fk]f ?kdf kl/dfhg tyf ; zfv]g ub{nl]g'kg[ePsf]h]o; lfq leqsf lhNnf lj sf; ; ldltx?, gu/kflnsfx?, cG0 ; DalGwt lgsfox? / lj1x? ; d] ; # ljleGg r/ofx?df cGt/lqmf, 5nkm Pj +lj rf/ ljdz{u/L kfk't /fo ; emfjx?sf] cfwf/df sf7df8f)pkTosf leqsf gu/kflnsfx? tyf gu/f]dv uf] lj sf; ; ldltx?sf]nflu of]lgdf0f ; DaGwl dfkb08 tof/ ul/Psf]xf]. of]dfkb08 sf7df8f)pkTosf gu/ lj sf; ; ldltsf]!!\$ cf]a]ssf]l; kmf/zdf g]kfn ; /sf/ dlGqkl/ib\$sf]@)^\$.!.* sf]lg0f0af6 @)^\$.@.! b]lv nfu"Xg]u/L :jLst ePsf]5 .

of]dfkb08 tof/ ubf{; flj sdf lgwfl/t dfkb08x?df b]lvPsf sdl sdhf]L / cefjx?nf0{; do; fk]f ?kdf ; wf/ ub{hlufsf]e"pkof]u, ; j{fwf/of hgtsf] ; jf:Yo ; fy}cG0 cTofj Zos ; ljwfx?nf0{; d] Wofg lb0Psf] . o; dfkb08df ejg dfkb08; # ; DalGwt cG0 dfkb08x?nf0{klg ; dl]6Psf]5 .

of]dfkb08sf] ; xl sf0f]ogaf6 g}cJojl:yt zx/ls/of Pj +c; /lft lgdf0f sf0x?af6 pTkGg Xg] ; d:ofx? lg/fs/of ug{ ; xof]u kl]g] tYonf0{x]boud u/L o ; ; # ; DalGwt ; Dk0f{klfx?n]of]dfkb08nf0{k]efj sf/L ?kdf Joj xf/df nfu"ug]u/fpg]sf0f cf-cf'g]tkm]af6 ; xof]u k'/afpg' ; a\$]st]o Xg]5 .

dfkb08 kl/dfhg ; ldltsf ; b:ox?

- != ; of]hs - >L ; b{eQm ; f]f5] pkdxflgb]z, zx/L lj sf; tyf ejg lgdf0f lj efu
- @= ; x ; of]hs - >L k?iff]Qd 8uf]h, ; b:o ; lrj, sf7df8f)pkTosf gu/ lj sf; ; ldlt, cgfdgu/
- #= ; b:o - kdV ÷sf0f/L clwst, sf7df8f)dxfgu/kflnsf
- \$= ; b:o - kdV ÷sf0f/L clwst, nlntk/ pk-dxfgu/kflnsf
- %= ; b:o - kdV ÷sf0f/L clwst, eQmk/ gu/kflnsf
- ^= ; b:o - kdV ÷sf0f/L clwst, dl]ok/ lyld gu/kflnsf
- &= ; b:o - kdV ÷sf0f/L clwst, slt]kX gu/kflnsf
- *= ; b:o - ; efkl't=:yfglo lj sf; clwst/L, lhNnf lj sf; ; ldlt, sf7df8f)
- (= ; b:o - ; efkl't=:yfglo lj sf; clwst/L, lhNnf lj sf; ; ldlt, nlntk/
- !)= ; b:o - ; efkl't=:yfglo lj sf; clwst/L, lhNnf lj sf; ; ldlt, eQmk/
- !!= ; b:o - sfg]g clwst ef]ts of]hg tyf lgdf0f dGqfno, l; xb/af/, sf7df8f)

ljleGg lgsfo tyf cGt/lqmfaf6 kfk't /fo; emfjnf0{ ; dfj]z ug] / efiffut ?kdf kl/dfhg ug] sf0f]hlsf ; b:ox?

- != >L k?iff]Qd 8uf]h, ; b:o ; lrj - sf7df8f)pkTosf gu/ lj sf; ; ldlt
- @= >L blks vgn, sfg]g clwst - sf7df8f)pkTosf gu/ lj sf; ; ldlt
- #= >L hlj g k] fb bhfn, zfvf clwst - sf7df8f)pkTosf gu/ lj sf; ; ldlt
- \$= >L ldlynf >]7, 0[-hlgo/ - sf7df8f)pkTosf gu/ lj sf; ; ldlt
- %= >L /fd k] fb >]7, 0[-hlgo/ - sf-p-g=lj-of]sf=, =, sf7df8f)
- ^= >L s?off /Tg zfs0, 0[-hlgo/ - sf-p-g=lj-of]sf=, =, nlntk/
- &= >L /fh]z >]7, 0[-hlgo/ - sf-p-g=lj-of]sf=, =, eQmk/
- *= >L >]hg dNn, sDko6/ ck/b/ - sf-p-g=lj=, =, sf7df8f)

Ij ifo; Fl

kl/R5D - !
kl/efiff / ; fdfgo Joj :yf

!= kl/efiff !
@= ; fdfgo Joj :yf &

kl/R5D - @

sf7df8f)dxfgu/kflnsf, nIntk/ pkdxfgu/kflnsf, lStk/ gu/kflnsf / gu/f]dv uf=lj =; =x?df ul/g]lgdfQf ; DaGwl dfkb08

!= k/fgf]zx/L IfQ @
@= cfj fl; o IfQ &
#= ; :yffut IfQ !&
\$= cfBfl]us IfQ !(
%= ; Af0f IfQ !(
^= zx/ lj :tf/ IfQ @!
&= ; tx ; j f/L IfQ @#
*= lj dfg:yn IfQ @#
(= v]hsb IfQ @#
!)= gf/fo0flx6L b/j f/ Pl/ofsf]dfkb08 @#
!!= vf]hf lsgf/fdf lgdfQf ug] ; DaGwdf @\$
!@= ; eOm cfj f; (Apartment) ej g ; DaGwdf @\$
!#= lj lj w @\$

kl/R5D - #

dWok/ lydl gu/kflnsf IfQ leq ul/g]lgdfQf ; DaGwl dfkb08

-S_ k/Dk/fut cfj f; lo IfQ (Traditional Residential Zone) @
-V_ ; :yffut IfQ (Institutional Zone) \$
-U_ lj sf; l; n IfQ (Developing Zone) %
-3_ ; /lft IfQ (Reserved Zone) !)
-a_ xl/t IfQ (Green Zone) !)

kl/R5D - \$

eOm/ gu/kflnsf IfQ leq ul/g]lgdfQf ; DaGwl dfkb08

!= k/Dk/fut ; fFs[ts cfj f; lo IfQ @
@= lj sf; zln IfQ !!
#= xl/t IfQ @)

kl/R5b - %

ej g dfkb08; # ; DaGwt cGo dfkb08x?

!=	kzklit lfgsf]dfkb08	@
@=	lj B't lgodfj nl / 5f8g' kgIb/l	*
#=	kDk ; DaGwl gkfn cfon lgudsf]dfkb08	!@
\$=	l; gdf xnsf ; DaGwdf rnlrq ; DaGwl dfkb08	!&
%=	; eOm ; fdlxs / ofhgj 4 cfj f; ; DaGwl dfkb08	!(
-s_	eflts ofhg tyf cfj f; ; DaGwl	!(
-v_	; eOm cfj f; (Apartment Housing)÷ ; fdlxs cfj f; (Group Housing) ofhg cgdlt (Planning Permit) ; DaGwl klqmof	!(
-u_	; eOm cfj f; ej g (Apartment Housing) lgdf	@)
	; DaGwl dfkb08	@)

kl/R5b - ^

cg; lrx?

kl/R5b - &

gS; fx?

kl/R5ϕ !

kl/efiff / ; fdfio Joj :yf

kl/R5b !

!= kl/efiff

!=) lj ifo j f k| un]csf{cy{gnfudf o; dfkb08df

æ; ldtæ eGfn]sf7df8f)pkTosf gu/ lj sf; ; ldt ; æng' k5{.

æ; xfos-pkofuæ (Accessory Use) eGfn]; fdfotof dVo kpfhgdf gcfpg] t/ vf; kpfhgdf]lgldQ ; 3fp klgl]sl; dsf]3/ hlufsf]sg}klg ksf/sf]pkofunf0{; æng' k5{.

ækl/j tGæ (Alteration) eGfn]Ps Isl; dsf]lgdf{fsf] :jLs[t ln0{jf Ps Isl; dsf]pkofuaf6 csf] Isl; dsf]pkofudf km]j bn ug]jf lfkkm jf prf0df yk36 ug]jf cfj thfj tsf cfwf/df g}kl/j tG ug]jf To; nf0{agb ug]jf :jLs[t ; Argdf g}kl/j tG ug]h: tf sfo{; æng' k5{.

æ; jLs[tæ eGfn]cf^gf]lfqflwsf/ leq /xl ; DalGwt lgsfon]lbPsf]:jLs[t ; æng' k5{.

æaDun jf 5fgf dlgsf]efuæ (Attic) eGfn]; /; kmf0{; DaGwl (Sanitary) kpfhgdf cfp]afx\$:6f]sf] lgldQ jf vfgf ksfpg] a:g]jf khf ug]h:tf sdfs]lgldQ pkofu ul/g]efu ; æng' k5{.

æclwsf/ kkt clwsf/Læ eGfn]; ldt jf ; ldtâf/f clwsf/ ; lDkPsf]clwsf/L ; æng' k5{.

Æ:yfglo lgsfoæ eGfn]; DalGwt gu/kfnsf jf ufp]j sf; ; ldt ; æng' k5{.

æafbhlæ (Balcony) eGfn]sg}klg ejgdf ePsf] 5\$]f/ (Handrail jf Balustrade) ; lxtsf] cfj t hfj t jf a:gsf]lgldQ kpfu ul/g]ejgsf]ufx]eGbf j flx/ lgsflnPsf]efu ; æng' k5{.

æEfl'dut tnf jf sf]fæ (Basement or Cellar) eGfn]hldg dflgPsf]; txf6 k/}tn jf !=@ ld6/ ; Dd dfq dflly agf0Psf]ejgsf]; æGbf tNnf]efu ; æng' k5{.

ælgdfæ eGfn]sg}klg lgdf (Structure) sf]sg}klg efu hg; s}p2]on] / hg; s}; fdfulln] agf0Psf]eP tfklg dflg; sf]cfj; sf]lgldQ xf] jf gxf] / h; cGtu hu lknGy (Plinth), uxf]?, e0{ 5fgf, lrlDg, knlDæ / ejg ; DaGwl cGo ; ljwfx?sf ; fy}lg]Zrt knb km]d{ j/08f, jfbhl, sfg] (Cornice) jf jflx/ lgsflnPsf]efu (Projection) / sg}lr6x jf aflx/ lgsflnPsf]sg}lgdf jf efunf0{5flg jf 5flg]p2]on]ul/Psf]lgdf jf uxf]sf]sg}efu ; æng' k5{.

æc; Da4 (Detached) ejg jf lgdfæ eGfn]Ps cfk; df ghfl]8Psf ejg jf lgdf ; æng' k5{.

æEjg jf lgdf{fsf]prf0æ eGfn]; dyn 5fgf (Flat Roof) sf]xsdf kâz ; 8ssf]s]b]; txf6 ejgsf] dfllyNnf]; tx; Ddsf]prf0{/ kfvf] 5fgf (Sloped Roof) sf]xsdf kâz ; 8ssf]s]b]; txf6 @%-#) l8ul eGbf a9l le/fnf] (Slope) ePdf le/fnf]lar efusf]prf0{Dd / ; f]eGbf sd le/fnf]u/L 5fgf lgdf ePsf]df d7n (Eaves) ; tx ; Ddsf]prf0{; Demg' k5{.

ælgdf /y]æ (Building Line) eGfn]sg}klg lgdf{fsf]lgldQ elj iodf lj :tf/ ug{; lsg]af6f]3f6f]jf e0{x\$]af6f]hf0{lj :tf/ ug]qmdf clwsf/ kkt clwsf/ln]tfl]sibPsf]lg]Zrt /y] ; Demg' k5{.

æsfk Pl/ofæ (Carpet Area) eGfn](Covered Area) uxf]sf]lfqkmn afx\$ sg}klg tnfsf]pkofu xg] sf]fx?sf]lfqkmn ; æng' k5{.

æRff\$Æ (Court or courtyard) eGgn]hldgsf]; tx jf ; f]eGbf tn jf dfly, k'/f jf cflzS ?kdf ejg jf kvf{fn}3/\$f]lgdfQf leq jf aflx/ /x\$]/ / cfsf; tkm{vhf /x\$]}(Open to sky)efu ; æng' k5{.

æleql rff\$Æ eGgn]rf/|t/af6 lgdfQf e0{3l/Psf]rff\$; æng' k5{.

æaflx/L rff\$Æ eGgn]slDtdf Ps tkm{lgdfQf ge0{vhf /x\$]}jf Ps tkm{g3l/Psf]rff\$; æng' k5{.

ælj sf; Æ eGgn]hldgsf]sg}klg ; tx jf efudf ul/g]lgdfQf jf e0{x\$]}lgdfQf sfohf0{kl/j tG u/L gofF?k lbg]jf lgdfQf ug{klqmf ; æng' k5{.

ælgsf; Æ eGgn]j iff\$]kfgl, 9n jf kQf]u ul/Psf]kfglsf]lgsf; sf]nflu agf0Psf gfnl (Conduit jf Channel _ ; æng' k5{.

æ3/ jf ejgÆ eGgn]a:g] vfgf ksfpq]/ ; /; kmf0{; DaGwl cfj Zos ; lj wfx? ePsf]cfj f; sf]lgldQ lgdfQf ePsf]ejg ; æng' k5{/ ; f]zAbn]sfohf0 ejg, xfb]h, sf/vfgf jf o:t}k\$]/n]dflg; x? a:g]j f sxl ; dosf]lgldQ hDdf xg]dggf]-hgsf :yfgx?nf0{; d] hgfpq\$.

æ9flsPsf] lffqkmÆ (Covered Area) eGgn]tkl; ndf pNn]v ePsf efu afx\$]sf] sg}klg k\$]/sf] lgdfQfâf/f rlrPsf]lkn6y (Plinth) ; tx eGbf nut}dflysf]k'/f efunf0{9flsPsf]lffqkm ; æng' k5{.

- s_ au]f, Og/ / o; ; DaGwl lgdfQf, lj ?j fx?sf]g; l, kfgl kf]y/L / kmf]f]f, kf\$]l vllg]vhf kf]y/L, rf]f/f, 6sl, a]r, lrknQl, emhf, h:tf aflx/L a:t' cflb .
- v_ lgsf; sf]nflu agf0Psf]sNe6{ kfgl hfgsf]nflu agf0Psf ; fgf gfnlx?, Sofrlk6 (Catch pit), uNnl lk6 (Gully Pit), OG; k\$; g r]a/ (Inspection Chamber), 88 (Gutter) cflb .
- u_ sDkfp08 3g{ nuf0Psf] kvf{h, 9f\$]f (Gate), tnf gp7f0Psf] 8p8l (Porch / Portico), vhf e/âfE, /âfDk (Ramp) aflx/ k6xl em08Psf](Over hang) emâfn / uf/f]eGbf aflx/ k6xl k/\$f] Awning 5ftfn]9fs\$]efu cflb .
- 3_ uf8{a:g]sf]f, kDk xfp; , kmf]f]f kmf]g] 7fQ, lj Bt\sIf, ; j :6zg cflb h:tf ; jf k'/âfpg cfj Zos xg]lgdfQf (Structure) cflb .
- a_ 3/sf]sg}efudf Sofl66nQ/ (Cantilever) lgsfnl ; f]efunf0{sf]f]sf]?kdf kQf]u gul/Psf] efu .

æcfj fl; o 3g]jÆ (Residential Density) eGgn]sg}lg]Zrt lffqdf ePsf]3/sf]; Vof ; æng' k5{.

æaflx/ lg:sg]af6fÆ (Exit) eGgn]sg}klg ejg jf lgdfQfâf6 aflx/ lg:sg]dflwdsf]?kdf kQf]u xg] :yfg ; æng' k5{.

ækrf0/ ; k/zgÆ (Fire Separation) eGgn]cfuf]km]gaf6 /f\$gsf]lgldQ ul/Psf]ejg jf lgdfQf{x?sf] lj efhg ; æng' k5{.

æe0Æ (Floor) eGgn]; fdfgotof dflg; x? lx8g]ejg jf lgdfQf]sf]sg}klg tnfsf]tNnf]; tx ; æng' k5{.

æe0{lff\$]cgkftÆ (Floor Area Ratio, (FAR)) eGgn]ejgsf ; Dk0f{tNnf?sf]lffqkm (Built up area) nf0{kn6 (Plot) sf]; Dk0f{lffqkmn]efu u/] cfPsf]efu kmn ; æng' k5{.

PkmP=cf/= (FAR)
$$\frac{\text{ejgsf] ; Dk0f\{tnfsf]sh lffqkm}}{\text{ejg ag]hlufsf] ; Dk0f\{lffqkm}}$$

ælofn/lÆ (Gallery) eGgn]e0\$]lffqkmndf a:g]; lj wdf a[4 xg]u/L sg}; efslf jf xnsf]ufx]âf6 aflx/ k6xl lgsfn] agf0Psf]alrdf kg](Intermediate) efu ; æng' k5{.

ælgħl ʊof/hæ eʎgn]sg}klg kʃf/sf lghl afxgx? kflsɛ ugʃf]lgldQ agf0Psf]jf kɔfɫ ul/Psf] ej g j f To; sf]efu ; æmg' k5{.

æ; fj hɪgs ʊof/hæ eʎgn]sg}klg kʃf/sf j f xgx? ddɛ ugɛ ef8fdf lng lbg, lj qml ugɛ :6fɫ ugɛ kflsɛ ugʃf]lgldQ agf0Psf]jf kɔfɫ ul/Psf]lghl ʊof/hæ afxʃsf]ej g j f To; sf]efu ; æmg' k5{.

æ; fdɪxs cfj f; æ (Group Housing) eʎgn]Ps}; æyf j f lgsfon]; fdɪxs :j fldTj ePsf]hldgd f lgldɛ u/ʃf]Ps tn]j f wɫ}tnfx? ePsf]a; fæf; ugɫ3/ j f :yfgx?sf]; dɫ ; æmg' k5{.

ælgj f; ofɫo sfɫæ eʎgn]kɔfɫ kɔfɫudf gcfpg]j f 5fɔf]; dosf] nflu dfq kɔfɫ xg]vfnsf afy?d, zɫfno, e08f/, sfɫ/8fɫ h:tf sfɫfx? afxʃ Ps j f ; f]eɔf a9L JolQmɫ? a:g] ; [g] cɫboog ugɫj f vfg]/ eɔf; fsf]xsdf vfg]j f a:g]p2ɫon]agf0Psf]sfɫf ; æmg' k5{.

æln^6æ (Lift) eʎgn]dfɫg; j f j :tx?nf0{lj leɔg tnfx?df kɫg j f k/ɔfpgsf]lgldQ h8fg ul/Psf]oɔg ; æmg' k5{.

ænf]6æ (Loft) eʎgn]le/fnf]k/ʃf]5fgfsf]afɛL /xʃf]efudf lgldɛ e0ʃf]; fdfɫo ; txegɔf dɫy /xʃf] clwstd !=% ld= sf]prf0{ePsf]e08f/ (Store) ugɫp2ɫon]agf0Psf]j f pkofɫ ul/Psf]efu ; æmg' k5{.

ædhɫgg ^nf]æ (Mezzanine Floor) eʎgn]tɫnf]tnfaf6 dfq hfɫ]af6f]ePsf]hldgsf]; txegɔf dɫy /xʃf]sg}b0{tnfx?sf]alrdf kgɫefu ; æmg' k5{.

ævhf efuæ (Open Space) eʎgn]kn6df vhf 5fl8Psf]efu ; æmg' k5{.

gɫɫ M ej g j f lgdfɫfsf]sg}; f08 blɫv ; Dalɫwt ; f08 tkɫs}kn6sf]; Ldfɫg; Ddsf]ɫoɔtd b/Lnf0{vhf efu dɫlggɫ . o:tf]vhf efu gɫɫbf ej g j f lgdfɫɫblɫv kn6sf]; Dalɫwt ; Ldfɫg; Ddsf]; æɫɫbf glhs /xʃf] 7fɫaf6 gɫg'kgɫ .

æcuf8ɫsf]vhf efuæ eʎgn]sg}klg ej g j f lgdfɫfsf]cuf8ɫ k6ɫL /xʃf]kn6sf]lgdfɫ /ɫf blɫv kn6sf] cuf8ɫ k6ɫLsf]; Ldfɫg; Ddsf]; æɫɫbf glhs /xʃf]7fɫaf6 gɫɫbf cfPsf]efu ; æmg' k5{.

æ5ʃfæ (Partition) eʎgn]sg}klg ej g j f lgdfɫfsf]alrsf efux? 5ɫɫfpgsf lgldQ sg}klg kʃf/sf]ef/ glng]u/L a9ldf Ps tnf ; Ddsf]prf0{dfq xg]u/L p7f0g]j f nuf0g]j f / j f ufxɫ]cɫɫb ; æmg' k5{.

æɫknɫyæ (Plinth) eʎgn]sg}klg ej g j f lgdfɫfsf]hldgsf]; txegɔf dɫy / e0ɫnfsf]; tx eɫɫbf dlgsf] efu ; æmg' k5{.

æɫknɫysf]ɫfɫkmæ eʎgn]eldut tnf j f sg}tnfsf]ufxɫ]; lxtsf]efun]9flsPsf]; Dk0f{e0ʃf](Covered Floor) ɫfɫkm ; æmg' k5{.

æ8ɫ9ɫæ (Porch) eʎgn]sg}klg ej gsf]kɫ ɫæf/ cufɫ8 kʃL dɫɫyaf6 9fs] agf0Psf]efu ; æmg' k5{.

æ; 8sæ eʎgn]uf8L ; dɫ: u8ɫ ; Sg]; a}ɫsl; dsf]af6f]; æmg' k5{.

æ; 8s-/ɫfæ (Road Line) eʎgn]af6fɫsf]sg}; f08x?sf]afɫx/L l; df lgwfɫ0f ugɫɫ/ɫf ; æmg' k5{.

æsf]ɫsf]prf0æ eʎgn]tof/L e0ʃf]; txɫɫv dɫy tof/L l; lnɛsf]; tx; Ddsf]b/L ; æmg' k5{.

ækliəmə4 cfj f; **Æ (Row Housing)** eġgn]cuf8l / k5f8l k6&l j f lj rdf vhf efu /flv hfl]8P/ agʒf] ej gxʔsf]kliəm ; əmg' k5{.

æPs cfk; df ; Da4 ej g**Æ** eġgn]tlg ; f08xʔ vhf e0{Ps ; f08df sg}csf]ej g j f lgdfŋf; ʔ hfl]8Psf] ej g ; əmg' k5{.

æ; j f dfu{eġgn]; lj wf j f ; j f k'/ɔfpg]p2ʒon]ej g j f kn6sf]k5f8l k6&l /xʒf]af6f]; əmg' k5{.

æ; ʔlofs nf0ġÆ (Set back line) eġgn]; Dalŋwt clwsf/Ln]sg}klg kʒf/sf]lgdfŋf ug{gkfp]u/L kn6 leq]kn6sf]; ldfgfsf]; dfgfŋt/ xg]u/L sf]l/Psf]/v f ; əmg' k5{.

ækno6Æ eġgn]aflx/L l; dfgfxʔ :ki6 xg]u/L vhf]hldgsf]6qmf j f efu ; əmg' k5{.

æsg/ kn6Æ (Corner Plot) eġgn]b0{j f ; f]eġbf wʒ}af6fʒʔ Ps cfk; df sf]6Psf]hŋ; gdf k/ʒf]/ To:tf af6fxʔ k6&l dfʒ8f ePsf]kn6 ; əmg' k5{.

ækno6sf]ulx/f0Æ (Depth) eġgn]kn6sf]cuf8l / k5f8lsf]; ldfgf alrsf]b7/L (Horizontal Distance) ; əmg' k5{.

æ8j n kʔ6h kn6Æ (Double Frontage) eġgn]sg/ kn6 afxʒ b0]6f af6fʒʔ tkm{dfʒ8f ePsf]kn6 ; əmg' k5{.

æe/ɔfEsf]9sgÆ (Stair Cover) eġgn]e/ɔf^anf0{9fSg]j f 5fl]g]p2ʒon]agf0Psf]5fgf ; lxtsf]sg]efu j f lgdfŋf ; əmg' k5{.

ætnfÆ (Storey) eġgn]ej g j f lgdfŋf]b0{e0ʒʔ (Floor) j f 5fgf alrsf]efu ; əmg' k5{.

ædflyNnf]tnfÆ eġgn]k/f j f cfz s ʔkdf lgdfŋf ul/Psf]ej g j f lgdfŋf]e0ʒ]tnf dflysf]tnf ; əmg' k5{.

æaf6fÆ (Street) eġgn]sg}klg kʒf/n]; j {fwf/0f hgtn]lx8g]u/ʒf]j f sg}lgZrt ; do ; Ddsf]nflu lgj fw ʔkdf lx8ʒf]; flj sssf]j f sg}ofhg f cġtuġ k|tflj t ePsf]cfj t hfj tsf]lgldQ kŋfl ePsf]efu (Means of Access) ; əmg' k5{. ; f]zAbn]; 8ssf]kʔl, 6kms cf0Nof08, ; 8ssf ʔvxʔ, /lŋE h:tf af6fʒf] /v fleq kg]; Dk0f{efu ; d]nf0{hgfp55 .

æaf6fʒf]prf0{j f uʒÆ (Street level or grade) eġgn]kn6sf]cuf8l k6&l cfkrfl/s ʔkdf lgwfŋf ul/Psf] af6fʒf]sŋbŋ /v fsf]prf0{(Elevation) ; əmg' k5{.

æaf6fʒf]/v fÆ (Street Line) eġgn]af6fʒf]bʒ} ; f08xʔsf]aflx/L l; df lgwfŋf ug]/v f ; əmg' k5{.

æ6-Pj ɔÆ (To Abut) eġgn]; 8ssf]; ldf; Dd lj :tf/ ul/Psf]ej g lgdfŋf]sg}klg efu ; əmg' k5{.

æj /08fÆ (Verandah) eġgn]sldtdf klg Ps ; f08 j flx/ tkm{vhf /fvl 9flsPsf] lfŋ (Covered area) ; əmg' k5{. o:tf]j /08f dfllyNnf]tnfdf ePsf]v08df vhf efudf nuf0Pʒf]! ld6/sf]prf0{; Ddsf]kof/flk6 (Parapets) nf0{; d] ; dfj ʒ ePsf]dfllggʒ .

æcfotg / kn6sf] lfgkmm cgkftÆ (Volume to plot area ratio) eGgn]le=k=cf/= ej g j f lgdff[fsf] 3g ld6/ lgsflnPsf] ; Dk0f{ cfotg (Volume) nf0{kn6sf] j u{ld6/df lgsflnPsf] ; Dk0f{ lfgkmmn] efu u/} cfPsf]efukm ; æmgk5{. o; /l cfPsf]value nf0{ld6/df pNn}y ul/g5 .

æzffnoÆ eGgn]dflg; x?nf0{lb; flk; fj ug{lglDQ agf0Psf]kfgl ^n; ug{]f kfgl xflNg xg]JoJ :yf ; lxtsf]sf]7f j f o:t}k\$fsf/sf]sg}klg efu ; æmg' k5{.

æmbfnÆ eGgn]sg}klg ej g j f lgdff[fsf]leql efunf0{cfj Zos kg[k]s[ts p Hofnf]/ e]6n}zgsf]nflu agf0Psf]9f\$ f afx\$sf]vhf efu ; æmg' k5{.

@= ; fdflo Joj :yf

o; kl/R5}df] ; fdflo Joj :yf o; dfkb08n] ; d}sf ; a}lfgx?df nfu" xg5 . t/ o; kl/R5}df pNnlvt ; fdflo Joj :yfsf]klj wfg kl/R5} - # / \$ sf klj wfg; # aflemPdf aflemPsf]xb; Dd kl/R5} - # / \$ sf klj wfg nfu" xg5 .

@=) **cfj thfj tsf]lgldQ cfj Zos kg[k]zsf]dfwod (Means of Access)**

@=! sg}klg ej g j f kn6df cfj thfj tsf]lgldQ cfj Zos kg[lghl j f ; fj h]lgs_ af6f]hf]8Psf]xg' kg5 .

@=@ sg}klg ej g agfp}f j f lgdff ubf{cfj thfj tsf]lgldQ cfj Zos kg[af6f]j f kj zsf]dfwods]lgldQ 56df0Psf]lfg dfly cltqmdOf xg]u/L j f ; f]sf]lfgkmm 36g]u/L agfpg kf0g]5g . sg}klg k\$fsf]lgdff ubf{csf]ej g j f lgdffnf0{o:tf]kj zsf]dfwodaf6 j lgrt xg]u/L ug{kf0g]5g .

@=# ; a}cfj fl; o kn6x? ; fj h]lgs af6f]j f o:tf af6f] Dd kl]g]c6l sg}dfwod; # hf]8Psf]xgkb5 .

kj zsf]dfwods]rf8f0{-dl=

kj zsf]dfwods]nDaf0{-dl=

!=@

#)=)

@=)

%)=)

\$=)

@))=)

^=)

!)))=)

*=)

@)))=)

!! / ; f]eGbf dfly

@))) eGbf dfly .

@=\$= cfBfl]us, z]lfs, l; gdf 3/, gfr 3/, ; ef xn, /æzfnf, ahf/ h:tf dflg; x? hDdf xg]vfnsf ej g j f

lgdffx? ubf{kj z dfwod slDtdf lgdg cg' f/ xg5 M-

kj zsf]dfwods]rf8f0{-dl=

kj zsf]dfwods]nDaf0{-dl=

*=)

@))=)

!!=)

\$))=)

!\$=)

^))=)

@@=)

^)) eGbf dfly

kn6 j f hluvsf]leq k6&l af6f]eGbf aflx/sf]af6f\$]rf8f0{; fgl]xg' x5g .

@=%= u}-cfj fl; o **(Non-residential)** j f !& dl6/ eGbf clnf ej g lgdffx?sf]; DaGwdf af6f]j f kj zsf] dfwods]cg' f/ xg5 M-

- s_ ej g jf lgdf; # hf]8g]dVo af6\$]rf8f0{*=} dl= e6bf sd xg' x5g / o:tf]af6]hf]8g] csf]af6\$]rf8f0{*=} dl= e6bf sd xg' kb5 .
- v_ kn6sf]dh kj záf/sf]rf8f0{slDtdf \$-% dl= xg' kg5 / o:tf]9f\$ leq tkm{vNg]lsl; dsf]xg' kg5 . kj záf/ 5f]kPsf](Covered) lsl; dsf]eP To:tf]Gogtd vhfkg (Clearance) \$-% dl= xg' kg5 .

- @^= kfy-j](Path -Way) - af6] ; 8s, leql kj zsf]dflodaf6 ej g jf lgdf; Dd kl]gsf]lgldQ kofu xg]kfy j](Path -Way) sf]rf8f0{!@ dl= e6bf sd / o; sf]nDaf0{#} dl= e6bf a9L xg' x5g .
- @&= Gog cfo ePsf ; dx?sf]lgldQ agf0g]b0{tnf; Dd prf0{ePsf]klQma4 jf ; fdbflos cfj f; sf]lgldQ kbn lx8g]af6\$]rf8f0{@ dl= xg' kg5 / o; sf]nDaf0{%} dl= e6bf a9L xg' x5g .
- @*= Joj:l:yt ?kdf a:tl lj sf; ul/g] lqdf clwsf/ kkt clwsf/Ln] aBf g#=# / @=\$ df kj zsf] dflodsf] rf8f0df a[4 ug{; Sg5 .
- @(= \$ dl= e6bf sd rf8f0{/ %} dl= e6bf a9L nDaf0{ePsf] af6] kj zsf] dflod; # hf]8Psf] a:tl lj sf; e0{x\$] lqdf To:tf]kn6sf]l; dfgfnf0{af6]jf To:tf]kj zsf]dflodsf]s]b/vf (Centre line) af6 @=) dl= k/ x6f0{To:tf]af6]jf kj zsf]dflodsf] rf8f0{f0{\$=} dl= agf0g5 / :yfol lgdf sfo{ugf0{kj z dflodsf]s]b/vfaf6 # ld6/ 5f8} dfq lgdf ug{lb0g5 .
- @!) = sg}klg af6\$]jf kj zsf]dflodsf]lgldQ tfl]sPsf]Gogtd rf8f0{g}sd xg]u/L s; h]sg}lgdf u/]jf c6o slx j :t' /fvdf clwsf/ kkt clwsf/n]To:tf]lgdf jf j :thf0{Toxfaf6 x6fpg ; Sg5 / ; f]x6fP jfktsf]vr{; DalGwt JolQmaf6 c; h ug{; Sg5 .
- @!!= /fhdfu cfj Zos xg] kbn kDk, dfh (Motel) h:tf ; jf afx\$ c6o sg}klg 3/ hluf, /fhdfu{jf dxTj k0f{; 8sx? -; 8s ljefusf]:jls[t lnP/ ; DalGwt clwsf/Ln] ; do ; dodf t\$] cg; f/_ af6 l; w} hf]8Psf]xg' x5g . ofhg dfkm\hf]8Psf]afx\$ /fhdfu{ # l; w}af6]hf8g kf0g]5g . t/ /fhdfu{jf c6o ; 8sx?sf]lj sf; sf]lgldQ cfj Zos ePsf]v08df pNn]vt zt6f 56 lbg ; lsg5 / o:tf]56 ; 8s ljefu / :yflgo ofhg; # ; DalGwt lgsfoaf6 :jls[t kkt ePsf]xg' kg5 .
- @!@= !%) dl= b]v #)) dl= ; Dd nDaf0{ePsf]-!%) dl= df yk df8 ; lxt_ kn6df uP/ 6lug]af6](Culde-sacs) cfj fl; o lqsf]nflu dfq cgdlt lb0g5 . o:tf]kn6df klx 6lug]af6\$]z?sf]lj Gb' (Starting point) sf] prf0{e6bf af6]6lug]7f8sf]prf0{a9L xg' kg5 . o:tf]af6\$]df8 (Turning point) sf]lqkmn *! ju{ dl= e6bf / o; sf]gfk (dl= e6bf sd xg' x5g .
- @!#= sg}klg ; 8sx? Ps cfk; df sl6P/ hS; g ag\$]7f8x?df ; f08 l8:6df; sf]lgldQ To:tf]hS; g k/\$] efunf0{ufhf]agfpg]jf sf6} ldnfpg]jf Psf kl6\$sf]; f08nf0{km/flsnf]kfg[kg5 .
- #= ; fdbflos vhf efu / c6o ; lj wfx?
- #=! sg}klg cfj fl; o / Jofkl/s lq{x?df)=@% x\$6/ jf ; f]e6bf a9L hldg ; dbfosf]kof]hgsf]lgldQ 56df0Psf]; fdbflos vhf efu To:tf]56df0Psf]hldgs}Ps cleG c#sf]?kdf ; /lft /Vg' kg5 .
- #=@= ofhgfa4 cfj fl; o lqdf vhf ; fj h]gs lqsf]nflu 56df0Psf]hldgsf]lqkmn lgDg cg; f/ xg5 # -c_ % /fkgl b]v !) /fkgl; Dd - hDdf hlufsf]% -kfF_ kltzt -cf_ !) /fkgl b]v @% /fkgl; Dd - hDdf hlufsf]\$ -rf/_ kltzt -0_ @% /fkgl b]v !)) /fkgl; Dd - hDdf hlufsf]#-% -; f9]tlg_ kltzt -0[!)) /fkgl e6bf a9L hlufsf]@-% -; f9]b0{ kltzt
- ## sg}Ps 7f8df /xg]vNnf efusf]Gogtd lqkmn #*) ju{dl6/ xg' kg5 .
- #\$= vhf efusf]lgldQ 56df0Psf]hldgsf]cfsf/ h:tf] s}klg xg ; Sg5 t/ To:tf]efusf]rf8f0{slDtdf * dl6/ xg' kg5 .

#%= vhf efudf lj >fd jf dgf]-hgsf]lgldQ kpfu xg]Ps tnf; Dd prf0{/ @% ju{dl6/; Dd lfgkm xg]sg} ksf/sf]lgdf ug; lsg . o:tf]lgdf{nf0{e0{lqsf]cgkft -PkmP=cf/= lgsfNg ; dfj z ul/g]5g / o:tf] ejg jf lgdf{df z}fno agfpg kf0g]5g .

#^= vhf efudf ; a}ejg jf lgdf{fx?af6 l; w}klg g; lsg]ePdf o:tf]efusf]lgldQ 56&}af6f]j f ToxfDd klgl dflwod xg'kg .

#&= lj >fd jf dgf]-hgsf]lgldQ 56df0Psf]vhf efusf]; ldfgfaf6 ejg jf lgdf{/yf slDtdf ! dl6/ k/ xg' kg .

#*= cfBflus lfgsf]?kdf hldgnf0{)=* x\$6/ jf ; f]e6f a9L xg]u/L 56df0Psf]eP To:tf]56df0Psf]hldgsf] hldf lfgkmsf]slDtdf \$ kl|tzt vfnl efu lj le6g ; jf ; lj wfsf]lgldQ xg]u/L 56dfpg'kg / o:tf] vfnl efu kfls[esf]nflu kpfu ug; lsg .

#(= Ps xhf/ ju{dl= jf ; f]e6f a9L hldg cfBflus lfgsf]lgldQ 56df0Pdf To:tf]56df0Psf]lfgkmsf]!) kl|tzt hldg lj le6g ; jf ; lj wfsf]lgldQ 56dfpg'kg / o:tf]vfnl efu pBfl leqsf ; Dk0f{sfdbf/x?n} pkofu ug; Sg]u/L 56dfpg'kg .

#!=) = c6o ; jf jf ; lj wfx?

56df0Psf]hldgsf]lfgdf /xsf]hg; wofsf]cfwf/df ; fdbfos vNnf efusf]cltl/Qm lgDg ; lj wfx? klgl clwsf/ kkt clwsf/Ln]tf\$]adfl]hd Joj :yf ug{kg M-

-s_ z]lfs ; lj wfx? Mg; lL :sh, kfylds :sh, lgDg dflwolds :sh, dflwolds :sh jf SofDk; x? cflb .

-v_ :jf:Yo ; Da6wL ; lj wf MIsnlgs, :jf:Yo rfsL, cf]wfn, c:ktfn cflb .

-u_ Jofkl/s ; lj wfx? Mj y, k; n cflb .

-3_ ; ~rf/ / c6o h?/L ; jf ; Da6wL ; lj wfx? M kx/L, 6l]nkrf, 6l]nuflkm af?0fo6q cflb .

-a_ ; fdfhs, ; fdbfos / ; fEs[ts ; lj wfx? Mwld\$ ejg, ehg 3/, ; dfh; jf tyf slNofOf s]b] l; gdf, Sna cflb .

#!! = hldgsf]kTo\$ pklj efhg jf efux?df s]b]jf :yfglo lgsfosf]; du|lj sf; of]hgf cg?ksf]Joj :yfx? ePsf]xg'kg .

\$= kn6 (Plot) sf]lgldQ cfj Zos Joj :yfx? .

\$! lgdf{ ul/g]sg}klg kn6df kmxf] jf c6o cfklQhgs j :tx?af6 dQm ePsf]xg'kb . sg}kn6 jf kn6sf] sg}efudf To:tf j :tx? eP To:tf a:tx? Toxfaf6 gx6fP; Dd sg}klg ksf/sf]lgdf ug{x5g .

\$@ kn6 cfl; nf](Damp) ePsf]v08df jf kn6sf]df6f\$]k\$[tn]ubf{cfl; nfkgnf0{/f\$g'h?/L ePdf cfj Zostf cg?ksf]cfl; nfkf /f\$g](Damp Proofing) sfo{ug{kg .

\$# sg}klg hldgdf vNnf efu, k] h cflb ; lxt plrt ksf/n]kfgl lgsfz xg]Joj :yf xg'kg .

\$=\$= 9n (Sewer) df sg}klg ksf/sf]lgsfz (Sub soil or surface water drain) hf\$g'k/df ; Dal6wt clwsf/Lsf]lnlvt :jLs[t lng'kg .

\$%= lj Bt lgodfj nln]tf\$]l] Bt nf0gsf]bf6f af6fsf]b/L leq sg}klg ksf/sf]lgdf ug{jf ejgsf]sg}klg efu p7fpg jf km]abn ug; d] kf0g]5g . lj Bt lgodfj nlsf]kfj wfg kl/R5b - % df /flvPsf]5 .

\$^ af9lsf]k\$[t / gblsf]lsgf/f x]] ejg lgdf{ jf c6o lgdf{ ug{gkfp]kpf]hgsf]nflu ; Dal6wt clwsf/Ln] hndfu{jf hnlfq b]v kn6; Ddsf]b/L tf\$g ; Sg .

\$& k/fgf]zx/L lfg afx\$sf]c6o lfgdf cfj fl; o kn6sf]lfgkm slDtdf klgl b0{cfgf b0{k}f -*) ju{dl= _ xg' kg / lgdf{sf]k\$[t cg; f/ cufl8sf]efu slDtdf klgl lgDgfg; f/ xg'kg M-

lgdf@fsf]k\$[t

c; Dj 4 (Detached) ej g j f lgdf@f
Ps cfk; df ; Dj 4 (Semi-detached)
ej g j f lgdf@f -
kl@ma4 (Row type) ej g j f lgdf@f

cuf]8sf]efu (Frontage)

- !) dl= eGbf dfly
- * - !) dl=
- \$ - * dl=

t/ kn6sf]cuf]8sf]efu (Frontage) / kn6sf]ulx/f0{(Depth) sf]cgkft !=% eGbf a9L xg' xB@ .

\$=* = ; fdlxs cfj f; (Group housing) sf]lgldQ cfj Zos xg]kn6sf]Gogtd ; f0h u? of]hgf / :yfglo lgdf@f ; DaGwl lgoddf pNn'y eP cg' f/ xg\$.

\$=(= cfBflus lqsf]kn6sf]lqkmm sldtdf @)) j u{dl= / o; sf]rf8f0(!) dl= eGbf sd xg' xB@ .

\$=!)= cGo lsl; dsf]pkofly h:t}z}lfs, ; ef, l; gdf, k\$ kDk h:tf pkoflysf lgldQ cfj Zos xg]kn6sf]; f0h aBf g=\$=! , \$=!@ / \$=!# sf]cfwf/df clwsf/ klt clwsf/ln]tflslbP cg' f/ xg\$.

\$=! ! ; fj hlg\$?kdf kofly xg]; l6 ; wof lglZrt ePsf]dfly; x? hDdf xg]vfnsf]; gdf 3/, gfr3/, h:tf sf] nflu kn6sf]; f0h 5bdfpBf klt ; l6 # j u{dl6/sf]b/n]5bdfpg' kg\$.

\$=!@ ; fdbflos xn (Community hall) x?sf]nflu kn6sf]; f0h sldtdf klg *) j u{dl= xg' kg\$.

\$=!# k\$ kDk ; DaGwl dfkb08 kl/R5@ - % df ; dfj z 5 .

%= kn6 leqsf]vhf efu (Open space)

%=! dflg; a:g]lx; fan]agfPsf ; a)sf]7fx? aflx/L j f leql vhf efu j f vhf a/08f; w hfl]8Psf]xg' kg\$.

%=@= aflx/L j f leql vhf efux? sf]7fdf cfj Zos xg]k\$sz / e]6n}zgsf]nflu ePsf]xg' kg\$. sg}ejg j f lgdf@fsf]sg}efu af6f]tkm(kmsPsf]eP To:tf]7f]df 5f]8g]vhf efu elj iodf af6f]hf0{kmlsnf]kfg; d] kof]t xg]u/l 5f\$@' kg\$.

%=#= sg}klg ejg j f lgdf@fsf]lgldQ 5b@}vhf efux? xgkg\$ / b0}j f b0{eGbf a9L ehf (Wing) x? ePsf] ejg j f lgdf@fdf k]o\$ ehfx?sf]k\$sz / e]6n}zgsf]nflu 5b@}vhf efux? xgkb\$. t/ & dl= eGbf sd prf0{ePsf ejg j f lgdf@fx?df dVo (Main) / ; xfos (Accessory) ejg j f lgdf@f alrsf]lj efhg ! dl= eGbf sd xg' xB@ .

%=\$= cfj fl; o ejg j f lgdf@fx?sf]nflu cfj Zos vhf efux? M

%=\$=! = j flx/L vhf efux?

%=\$=! != **cuf]8sf]vhf efu M** af6f]tkm(df}8f ePsf]; a)ejg j f lgdf@fdf cuf]8L k6@ lgDgfg' f/sf]vhf efu xgkg\$ M

Gogtd vhf efu -dl= kn6sf]cuf]8L k6@Lsf]af6f]sf]rf8f0{-dl=

!) dl= \$=) dl= / ; f]eGbf dfly

-s_ \$ -rf/_ dl= eGbf sd rf8f0{ePsf]df/ af6f]sf]nflu ejg j f lgdf@f /yf af6f]sf] s]baf6 sldtdf klg #)= dl= xg' kg\$. %) dl6/; Ddsf]nDaf0{ePsf]/ Dead end ePsf] uf]8f]sf]5paf6 ! dl6/ 5f8L dfq lgdf@f ug{kfpg\$. j f/kf/ nflg ; Sg]/ %) dl6/ eGbf a9L nDaf0sf]uf]8f]af6f]sf]s]b/}yaf6 @=% dl6/ 5f8L dfq lgdf@f ug{kfpg\$.

gf@ M

6@kmsf]l:ytL (Traffic Volume) sf]cfwf/df ; DalGwt clwsf/ln]sg}klg ; 8s j f af6f]sf] nflu Gogtd b/Lsf]l; df lgwf}of ug{; Sg]5 .

%- \$=!@= k5f8lsf]vhf efu

-s_ cfj fl; o k\$[tsf ; a}k\$ f/sf lgdf{fx?df k5f8 k6&l vhf efu /xg' kg\$. o:tf]vhf efusf]; fnfvfnf rf\$fo{!-% dl= xg' kg\$ / sg}klg 7f\$sf]rf\$fo{# lkm6 eGbf sd xg' x5g . ; f06sf] k\$[t Jofs-6'-Jofs ; f06 (Back-to-back site) ePdf k5f8lsf] vhf efusf]rf\$fo{; a}t/ !-%dl= xg' kg\$. k5f8lsf]vhf efusf]; fnfvfnf rf\$fo{lg\$fnbf kn6sf]rf\$fo{\$f]cfwf ; Ddsf]efunfo{dfq ; dfj z ul/g\$. (dl6/ eGbf sd ulx/f0{ (Depth) ePsf] & dl= ; Dd prfo{ePsf]ejg j f lgdf{fsf]nflu k5f8lsf]vhf efusf]rf\$fo{f0{# lkm6 ; Dddf 36fpg ; lsg\$.

-v_ b0{ j f ; f] eGbf a9L af6f{x?; # hf]8Psf] sg}klg lgdf{fsf] k5f8 k6&lsf] uxf[] j f kvf{fsf] k/} nDaf0{ Dd vhf efu 5f\$g' kg\$. clwsf/ k{k t clwsf/Ln} tf\$ l lbPsf] cj :ydf afx\$ k5f8l k6&lsf] uxf[] j f kvf{ eGgn] a9L rf\$fo{ePsf] af6f\$] k5f8l k6&l kg{efunfo{df lgg\$.

%- \$=!# = ; f08sf]vhf efu

sg}klg Ps cfk; df ; Da4 (Semi-detached) / c; Da4 (Detached) ejg j f lgdf{fdf lgDg cg' f/sf]vhf efu xg' kg\$ M

-!_ c; Da4 ejg j f lgdf{fsf]bj} ; f08 tkm{slDtdf klg !-% dl= sf]vhfefu xgkg\$.

-@_ Ps cfk; df ; Da4 ejg j f lgdf{fsf]Pstkm{slDtdf klg !-% dl= sf]vhf efu xgkg\$.

-#_ klQma4 lsl; dsf ejg j f lgdf{fdf ; f08 tkm{vhfefu cfj Zos kg[5g} .

%- \$=@= af6f\$]/\f (Street Line) j f kn6sf]cuf8l k6&lsf]l; dfgaf6 % dl= sf]b'ldf /x\$]# dl= ; Dd prfo{ePsf]kfls{sf]lgldQ kpfu xg]vof{/hsf]nflu aBf g+%- \$=!@= / %- \$=!# sf]JoJ :yf nfu" xg]5g} .

%- \$=#= aBf g+%- \$=!@= b]v %- \$=!# ; Dd pln]v ePsf]vhf efu ; DaGwl JoJ :yf & dl= ; Dd prfo{ePsf]cfj fl; o ejg lgdf{fsf]nflu nfu" xg\$.

%- \$=\$= prfo{& dl= eGbf a9L ePsf]ejg j f lgdf{fsf]nflu ; f08 k5f8l k6&l vhf efu Gogtd !-% dl= - % lkm6 _ xg' kg\$.

%- \$=%= -s_ leql rf\$ - sg}klg sf]fsf]sg}Pp6f ; f08sf]emfn - afy?d, zffrno, :6f] afx\$ _ sg}klg vhf efu tkm{gePsf]v08df To:tf]emfn slDtdf klg # dl= rf\$fo{ePsf]leql rf\$ tkm{hf]8Psf]xg' kg\$. leql rf\$sf] lfgkm, -k/}prfo{Dd_ rf\$ glhssf] uxf[]sf]prfo{sf]kfF efusf]Ps efu -!-%_ sf]j u{(Square) eGbf sd xg' x5g . sg}klg sf]f - jfy?d, Zffrno, e/afEsf]lgldQ 56df0Psf]7f\$ afx\$ _ k\$z / e]6n}zgsf]lgldQ leql rf\$ dfly lge{ /x\$]cj :ydf To:tf]rf\$sf]gfk ehf (Wing) ePsf]ejg j f lgdf{fsf]lgldQ cfj Zos eP cg' f/ g} xg\$. afy?d zffrno dfq leql rf\$; # hf]8Psf]cj :ydf leql rf\$sf]; f0h Gogtd @ j u{dl6/ xg' kg\$.

-v_ e]6n}zg zf^6 jfy?d, zffrnox?sf]lgldQ sg}vhf efu gePsf]v08df To:tf]jfy?d, zffrnox?sf]e]6n}zgsf]lgldQ cfj Zos xg]vhf efu e]6n}zg zf^6 lt/ vhf]xg' k5{.

Gff\$ M-

Po/ slG8; g (Air-condition) ; DaGwl plrt JoJ :yf ePsf] / ; f] sf]lgldQ cfj Zos phf{ (Power) sf]j \$]Nks >f] ; d] ePsf]cfj fl; o ejg j f lgdf{fsf]nflu e]6n}zg zf^6 /Vg h?/L kg[5g} .

-u_ j flx/L rf\$ - j flx/L rf\$sf]rf\$fo{slDtdf klg @\$ dl xg' kg\$. @\$ dl= eGb sd rf\$fo{ePsf]j flx/L rf\$nf0{sgf (Notch) sf] ?kdf ln0g\$ / aflx/L rf\$; DaGwl Joj :yf nfu"xg]5\$.

t/ aflx/L rf\$sf]rf\$fo{eGb ulx/f0{(Depth) a9l ePsf]v08df aBf g=# sf]Joj :yf nfu"xg\$.

%-\$^= ; @Qm vhf efu - ; @Qm ?kdf /flvPsf]leql j f j flx/L -j flx/L vhf efu af6f]k/\$f\$ afx\$ _ vhf efu To:tf ejg j f lgdf@fx?sf]kmf0bf j f ; lj wfsf]lgldQ xg' kb\$ / o:tf]efu kOfM ; DalGwt wgl (Owner) x?s}xftf (Premises) leq /xg' kb\$.

%-\$&= Afflx/L j f leql vhf efux? Ps}JolQm (Owner) sf Ps eGb a9l ejg j f lgdf@fx?sf]kmf0bf j f ; lj wfsf]lgldQ kOfu ug]ePdf vhf efusf]rf\$fo{aBf g=#- \$=# df pNn\ ul/Psf] ; aeGb clnf]ejg j f lgdf@fsf]lgldQ eP ; /xsf]xg\$.

%-\$*= o:tf leql j f aflx/L vhf efux? Ps eGb a9l JolQm?sf] :j fldTj df /x\$]ePdf o:tf vhf efudf k/\$f]cf'gf]cz -efu_ ; DalGwt ejg j f lgdf@fx?sf]kmf0bf j f ; lj wfsf]lgldQ kOfu ug{ lbg]lnvt dgH/L ; DalGwt wgl (Owner) x?n]lbg' kg\$. o:tf]vhf efu :yfol vhf efusf] ?kdf /xg\$ / o:tf]vhf efusf]alrdf !-% dl= eGb a9l xg]u/L sg}klg k\$ /sf] ; ldf kvf nufpg' x\$.

%%= cGo k\$ /sf pkoflux?

cGo k\$ /sf pkoflux?sf]lgldQ lgDg cg; f/sf]vhf efu /xg' kg\$ M-

-s_ z]lfs ejg j f lgdf@fx? - g; l :sh afx\$ cGosf]nflu ejg j f lgdf@ j l/k/Lsf]vhf efu slDtdf klg #=) dl= xg' kg\$.

-v_ ; :yfut (Institutional) ejg j f lgdf@fx? - o:tf ejg j f lgdf@ j l/k/Lsf]vhf efu slDtdf klg #=) dl= xg' kg\$.

-u_ ; ef ; Dd]hg j f el8 hDdf xg] (Assembly) ejg j f lgdf@fx?sf]lgldQ cuf8Lsf]vhf efu slDtdf !@ dl= / c? vhf efu slDtdf ^ dl= sf]xg' kg\$.

-3_ Jofkl/S (Business) Joj ; flos (Mercantile) / :6f] ; DaGwl ejg j f lgdf@fsf]lgldQ j l/k/Lsf]vhf efu @ dl= eGb sd xg' x\$. o:tf lgdf@fx? cfjfl; o lfg j f cfjfl; o ldl>t lfg leq k/\$f]v08df o:tf lgdf@fx? / cfjfl; o ldl>t lsl; dsf ejg j f lgdf@fx?sf]nflu pNn]vt vhf efu ; DalGwt Joj :yfdf sd ug{ ; lsg]5 .

-a_ cfBflus ejg j f lgdf@fsf]nflu j l/k/Lsf]vhf efu !^ dl= ; Dd prf0\$]nflu \$=% dl= eGb sd xg' x\$ / !^ dl= eGb dly kto\$ yk ! dl= sf]nflu)=@% dl= sf b/n]vhf efu a9fpg' kg\$.

Gff M-

Kn6sf]rf\$fo{!% dl= eGb sd ePsf zx/ leqsf ; fB/f cfBflus kn6x? / vf; af6f]/ /fhdfu{ blv pkoQm ?kdf k5fl8 /x\$](Set back) kn6x?sf]nflu eg]lj zif Joj :yf nfu"xg\$.

-r_ lj klQhgs (Hazardous) k\$ /sf pkoflu ; DaGwl lgdf@fx?sf]nflu j l/k/Lsf]vhf efu cfBflus ; DaGwl ejg j f lgdf@fx?sf]lgldQ eP ; /xs}Joj :yf nfu"xg\$.

%^= vhf efudf 5\$ lbg ; lsg]

%^=!= sg}klg leql jf aflx/l vhf efux? k0f?kn]vhf (Free) /flvg' kb5 . t/ lgDg sfo{x?nf0{vhf efu dfly kg[u/l 56 lbg ; lsg5 .

-s_ rf8f0{)=^) dl= e6bf a9l gxxg] u/l slg{ (Cornice) 5fgf jf j b/ ; 8 (Weather shade) /fvg kf0g5 .

-v_ rf8f0{)=^) dl= e6bf a9l gxxg] u/l em6fn, 9f5f cflbdf ; g ; 8 (Sun shade) /fvg kf0g5 .

-u_ a:g]sfddf gcfcpg]vfnsf]5xf/l (Canopy) nf0{To:sf]5xf/l / kn6sf] ; ldfgf alrsf] efu (Clearance) ! dl= xg]u/l klxfnf]tnfsf]e0sf] ; txd /fvg kf0g5 .

%^=!=! ; xfos ejg jf lgdf0f

vhf efudf lgDg cg' f/sf] ; xfos ejg jf lgdf0fnf0{cgdlit lb0g5M

-s_ e0/fv5f] ejg jf lgdf0fsf] k5f8l k66lsf] vhf efudf @=\$ dl= prf0{/ \$ ju{dl= lf0kmm ePsf] ; lg6/l (Sanitary) ; Da6wl lgdf0f ug{lb0g5 . o:tf]lgdf0f k5f8l k66lsf] kn6sf] ; ldfgfaf6 ! dl= sf]b/ldf xg' kg5 .

-v_ sg} ; 8ssf] /yf (Road line) jf kn6sf] cufl8 k66lsf] ; ldfgfaf6 % dl= k/ @=\$ dl= prf0{ePsf] kfls[ef] lgldQ agf0g] uof/hnf0{ ; f08 jf k5f18sf] vhf efudf agfpg cgdlit lb0g5 .

-u_ @=% ju{dl= ; Ddsf]kDk xfp; nf0{cgdlit lb0g5 .

%^=@= af6f]dfly kg[u/l agfpg jf lgdf0f ug{kf0g]cj :yf M

%^=@=!= a6f g+ %^=@=@ df pNny eP cg' f/sf] ; g ; 8 (Sunshade) e6bf afx5 alg; s5f] (Built-up) jf ; fB/f lf0x?df sg}klg k5f/n]af6f]dfly kg[u/l jf ; f08sf] ; ldfgfsf] aflx/ kg[u/l sxl klg agfpg jf lgdf0f ug{kf0g]5g .

t/ cfsfz]kfglsf]lgsf; sf]lgldQ cfj Zos kg[kf0k jf gfnf (Rain water spout) sf] nflu eg]clwsf/ kft clwsf/Ln]To:tf] :jls[t lbg ; Sg5 .

%^=@=@= em6fn / e]66n5zg dflysf] ; g ; 8 (Sun shade)

alg; s5f] (Built-up) lf0 jf ; fB/f lf0x?df clwsf/ kft clwsf/Ln]lgDg zt{x? k/f ug[u/l em6fn / e]66n5zg dfly ; g ; 8 agfpg] :jls[t lbg ; Sg5 M

-s_ ; 8ssf] ; tx (Road level) af6 @=&% dl= sf] prf0{ e6bf tn sg}klg k5f/sf] ; g ; 8nf0{af6f]dfly kg[u/l jf ; f06sf] ; ldfgfsf]aflx/ kg[u/l agfpg lb0g]5g .

-v_ ; 8ssf]rf8f0{* dl= e6bf a9l ePsf]v08df To:tf] ; 8s dfly kg[u/l hldgsf] ; tx e6bf @=&% dl= e6bf dfly /flvg]a9ldf)=#) dl= ; Ddsf] ; g ; 8 agfpg cgdlit lb0g5 .

-u_ *) dl= e6bf sd rf8f0{ePsf] ; 8s dfly kg[u/l sg}klg ; g ; 8 agfpg lb0g]5g .

%=&= vhf efusf] ; Af0f

%=&=!= k* {cgdlit ln0{ejg lgdf0f ubf{5f8ykg]vfnl 7f5 5f8y]u/l / yk gofFlgdf0f ug5f lgldQ lgodfg' f/ 5f8ykg]vfnl hluuf ; d] vfnl /fvg]u/l Pp6}hluufwglnf0{Pp6}kn6df yk lgdf0f ug{:jls[t lb0g5 .

%&=@ sg}ejg jf lgdf{df ul/g}yk (Addition) jf lj :tf/ (Extension) nf0{vhf efu ; DaGwl aBf g+%= \$ sf]JoJ :yf cg?k xg]eP dfq cgdlt lb0g\$.

^= lfqkm / prf0{; DaGwl ; ldf

^=! lj leGg k\$ f/sf j ul\$ /of cftuf kgI ejg jf lgdf{fx?sf] lfqkm / prf0{; DaGwl ; ldf lgwf{of ubf{e0{ lfqs]cgkftsf]cfwf/df ul/g\$. o; ; DaGwl sfo{ubf{lgDg s/fx? dfly Wofg lbg'kg\$ M

-s_ pkof]usf]k\$ f/ (Occupancy class)

-v_ lgdf{fsf]k\$ f/

-u_ ejg jf lgdf{fsf]dfx8f k6\$lsf]af6f]/ 6\$km\$sf]l:ylt

-3_ hg3gTj / Onfsf (Locality)

-a_ kfls\$; DaGwl JoJ :yf

-r_ cfuf]lgoGof ; DaGwl :yflgo JoJ :yf /

-5_ vfgkfgl tyf 9n lgsf; ; DaGwl JoJ :yf

^=@ lj leGg pklfq (Sub-zones) sf]kn6sf ; f0h, pkof]u / lgdf{fsf]ls; dsf]nflu thgf]ds e0{lfqs]cgkft (Floor area ratio) lj leGg lfq pklfqs]nflu pNn]vt tflnsdf pNn]y eP cg; f/ xg\$. clwsf/ klt clwsf/Ln]Ps k\$ f/sf]pkof]u / lgdf{fsf]k\$ f/ cg; f/ / cfwf/et e0{lfqs]cgkft lgwf{of ug[5g\ o; j ubf{c6o :yflgo j :t'l:yltnf0{; d] Wofgdf /fv] ug[5g\ - aBf g+^=! _

^=#= prf0{; DaGwl 56x? .

^=#!= 5fgdf /x\$]lgDg cg; f/sf efu jf lgdf{f sfo{nf0{ejg jf lgdf{fsf]prf0{df ; dfj z ul/g]5g .

-s_ 5fg dfly /x\$]e/dfE 5f]g]efu, kf/fk\$, 6df\$ / Itglx?nf0{c8dfpg]ufx]j f 6]f .

-v_ e]6n]zg, Po/ slG8; g, ln^6sf]sf]f cflb; # ; DaGwl oG jf lgdf{fx? .

^=\$= Po/kf\$]j l/kl/sf]lfqdf nfu"xg]lj z]f JoJ :yf M

^=\$!= Po/kf\$]j l/kl/sf]lfqdf xg]lgdf{fsf] prf0{gkfn gful/s p8dg kflws/of (Civil Aviation Authority of Nepal) sf]lgodaf/f lgb]zt xg\$ / o:tf]lfqdf xg]lgdf{f ; DaGwl sg}klg lj ifodf gkfn gful/s p8dg kflws/ofaf/f hf/L ul/Psf] ; aeGbf kl5Nnf]lgoddf pNn]y eP cg; f/ xg\$.

^=\$=@ Po/kf\$]j l/kl/sf]lfqdf lj z]f u/L gof]lgdf{f, xf06]; g / nf] 6]; gsf tf/x?, 6]nkrf]sf nf0gx?, sf/vfgsf lrlDgx?, tf/, l6-el= P66]fx? /fv\$]f xsdf aBf g+^=\$!= sf]JoJ :yf nfu" xg\$.

^=%= ; fdlxs cfj f;

^=%!= ; fdlxs cfj f; ; DaGwl lgdf{f sfo{; fdfGof / ck]lft ?kdf w]}tnfx? ePsf Ans g}xg'kg\$. o:tf]fdlxs cfj f; rng rNtl (Customary) sf]lx; fan]hldgnf0{kn6 / af6f?sf]lj efhg ug[vfnsf]xg'x\$.

^=%=@ tnfx? / prf0{; DaGwl ; ldfgf lj leGg lfq, pklfqs]nflu lj leGg kl/R5]df tf]sP cg; f/ xg\$; fy}o; n]; d\$]lfqkm (Area Coverage) / e0{lfqs]cgkft ; f]l kl/R5] cg; f/ xg'kg\$.

&= af6f]eGbf aflx/ k6\$lsf]kfls\$:yn

kn6df JoJ :yf ul/g'kgI af6f]eGbf aflx/ k6\$lsf]kfls\$ (On site parking) :yn lj leGg lfq, pklfqs]nflu ; DalGwt kl/R5]df tf]ad]hd xg'kg\$.

- (=# efc; fsf]?kdf kofu xg]sf]fx?sf]cGo Joj :yfx? lgDg adf]hd xg] M
- s_ efBfsBfx? wg]566}Joj :yf ePsf]f jfx\$ o:tf kfglx?sf]lgsf; l; w}j f l; Gs dfkm\ kinf] kfgl j lg]kf0k (Waste pipe) ; Dd xg' kg] .
- v_ kfgl l5g]g; Sg]vfnsf]e0{xg' kg] .
- u_ cfj Zos eP wFf hfg]lgsf; , /
- 3_ aBf g+!!=@ df pNn]v eP cg' f/sf] emfn, e]6n/ jf o:t}k\$ /sf] vhf efu (Opening) xg' kg] / o:tf]vhf efu (Opening) aBf g+!!=@ sf]g] # cg' f/ a9g klg ; Sg] .

(=\$ jfy?d / zfrfno

- (=\$! prf0{- jfy?d jf zfrfnosf]lgldQ sf]fsf]prf0{@ dl= eGbf sd xg' xB} .
- (=\$@ ; f0h - jfy?dsf]nflu sf]fsf] ; f0h !# dl= x !=) dl= eGbf sd xg' xB} . zfrfnosf]lgldQ rf8f0{Gogtd)=(dl= / Gogtd lfgkm !=! j u{dl6/ xg' kg] . jfy?d / zfrfno Pp6df eP To:tf]sf]fsf] ; f0h @@ dl= x != dl= eGbf sd xg' xB} .
- (=\$# cGo Joj :yfx? M k]o\$ jfy?dd / zfrfnosf]nflu lgDg yk Joj :yfx? nfu"xg] M
- s_ sldtdf klg Pp6f uxf]f j flx/L xj fsf]nflu vhf efu ePsf]xg' kg] .
- v_ kfgl gl5g]lsl; dsf] (Water-tight) e0{ePsf]cj :ydf jfx\$ sg}klg jfy?d jf zfrfno sg} sf]fsf]l; wf dfly jf tn - cf'gf]jfy?d, zfrfno cflb jfx\$ _ kg]u/L j gfgpg'xB} .
- u_ kfgl gl5g] ; fdfullaf6 / kfgl gl5g]lsl; daf6 agf0Psf]xg' kg] .
- 3_ jfy?d jf zfrfno rf/]t/af6 3V/Psf] (Enclosed) xg' kg] / To:tf] uxf]j jf kvf]ndf e0\$] ; txaf6 sldtdf ! dl= sf]rf8f0{ Dd kfgl gl5g] ; fdfullx?af6 ; tx ldnf0Psf]xg' kg] .
- a_ jfy?d jf zfrfnosf e0x? kfglsf]lgsf; jf 9n eP It/ le/fnf]kl/Psf]xg' kg] . sf]f jf j /08flt/ To:tf]jfy?d jf zfrfnosf]kfgl hfg]u/L le/fnf]kfg{xB} .
- r_ sg}zf^6 (Shaft) jf vhf efu tkm{vh\$]emfn jf e]6nzg xg' kg] / To:tf]emfn jf e]6nzgsf]lfgkm sldtdf)# j u{dl= / rf8f0{sldtdf)# dl= xg' kg] .

(=% 6fB (Ledge) nf]6 (Loft)

- (=%! prf0{- o; sf]prf0{sldtdf @! dl= xg' kg] .
- (=%@ ; f0h -dflg; a:gsf]lgldQ kofu xg]sf]fdf /xg]6f8 (Ledge) n]To:tf]sf]fdf lfgkmnsf] @%% eGbf a9L lfgkm cflu6g'xB} / o:tf]6f8n]sg klg cj :ydf sf]fsf]e]6nzgnf0{c; / kfg{xB} .
- (=%# nf]6 (Loft) - o; sf]clwtstd prf0{!=% dl= xg] . efc; f (Kitchen) df agf0g]xf]eg]o; n] efc; fsf]lfgkmnsf]@%% eGbf a9L lfgkm cflu6g'xB} / of]e0\$] ; txaf6 sldtdf klg @! dl= dfly /x\$]xg' kb] . jfy?d, zfrfno / sf]l/8f]df /xg]ln^6n]eg]zt kl]zt efu cflu6g]u/L j gfgpg ; lsg]5 .

(=^ d]hflgg ^nf] (Mezzanine Floor)

- (=^! prf0{- o; sf]prf0{sldtdf @! dl= xg' kg] .
- (=^@ ; f0h - d]hflgg ^nf]/sf] ; f0h lnleE ?d (Living room) sf]kdf pkofu ul/g]eP &=% j u{ dl= eGbf sd xg' xB} o:tf]d]hflgg ^nf]/sf]e0\$]ejgsf]lknGysf]lfgkm '=@ efu eGbf a9L xg' xB} .

(=# cGo yk Joj :yfx? - lgDg cj :yfdf d]hflgh ^nf]nf0{sf]f dfly kg[u/l agfpg cgdlt lbg ; lsg] M-

-s_ o:tf]ad]hflgg ^nf]E sf]lf]kmm &=% j u{dl= eGbf a9l xg]ePdf / o:tf]cj :yfdf k\$zf / e]G6n]zg ; DaGwl lnleE ?dsf]cfj Zostf ; dt] k/f xg]ePdf -xg]f] \abf g+!!!=@_

-v_ o; sf]tn j f dfly kg]e]G6n]zgsf]sg}klg efunf0{sg}klg cj :yfdf c; / gkg]ePdf,

-u_ o:tf]ad]hflgg ^nf]E nf0{; fg-; fg efux?df pk-lj efhg gul/g]ePdf,

-3_ o:tf]ad]hflgg ^nf]E j f o; sf]sg}klg efudf efg; fsf]?kdf kof]u gul/g]ePdf /

-a_ o:tf]ad]hflgg ^nf]E sg}klg cj :yfdf e]G6n]zg /lxt slfsf]?kdf kl/0ft ePdf .

(=& a0un (Attic)

dflg; a:gsf]lgldQ a0unf0{kof]u ul/g]ePdf o; df kof]t dfqdf e]G6n]zg / k\$zsf]Joj :yf ePsf]xg' kg] / o:tf]a0unf]prf0{x]f]efudf != dl= / w/l j f dflyNnf]efudf @# dl= eGbf sd xg' xGg .

(=* :6f] sf]f

(=*=! prf0{- o; sf]prf0{@=! dl= eGbf sd xg' xGg .

(=*=@ ; f0h - cfj fl; o ejgsf]:6f] sf]fsf]lf]kmm @ j u{ld= eGbf sd xg' xGg .

(=(llof/h (Garage)

(=(=! prf0{- o; sf]prf0{@=! dl= eGbf sd xg' xGg .

(=(=@ ; f0h - ; f0h lgDg cg; f/ xg' kg] M-

-s_ lghl llof/h]sf]; f0h Gogtd @=% dl= x % dl= xg' kg] .

-v_ ; fj h]lgs llof/h]sf]; f0h kflsE ug]j fxgx?sf]; \of cflbsf]cfwf/df xg' kg] .

(=! el'dut tnf (Basement)

(=!)=! el'dut tnfnf0{cfj f; sf]lgldQ kof]u ug{kf0g] 5g . el'dut tNnf cfj Zostf cg; f/ b0{ tNnf; Dd klg lgdf] ug{kf0g] .

(=!)=@ :yfglo lgdf] ; DaGwl Joj :yfx? tyf hluuf pkof]u ; DaGwl Joj :yfx? ; d]h vfg] u/l dfq el'dut tnf lgdf] ug{; lsg] .

(=!)=# l]leG lf], pklf] / af6f]?sf]nflu tf]sPsf]lgdf] /yf / ; \Aofs 5f]l affs ; Dkof{hluufdf a] d]6sf]kl/efiff]sf]pkof]u leq agfpg kfp] .

-s_ ; fdfGo k]j ngzln vfnf 3/h] j f cGo j :tx? :6f] ug]f lgldQ.

-v_ :6k ?d (Strong room), k5f8l k6]lsf]el'dut sf]f cflbsf]lgldQ .

-u_ ejgsf]; j f / ; ljwfsf]nflu kof]u xg]Po/ slG8; g ; DaGwl j f cGo d]zg j f o6qx?sf] lgldQ .

-3_ kflsE]sf]lgldQ .

(=!)= \$ el'dut tnfdf lgDg Joj :yfx? xg' kg] M-

-s_ el'dut tnf]prf0{sl0tdf @=! dl= xg' kg] .

-v_ kof]t dfqdf e]G6n]zgsf]Joj :yf xg' kg] .

-u_ sg]klg el'dut tnf 5f]g]e0Fslab top k]zdfu]s]b]; txaf6 a9ldf != dl= dfq xg' kg] .

- 3_ hldg dflysf]kfgl o:tf]eldut tnfdk k:g g; Sg]Joj :yf ul/Psf]xg' kg5 .
- a_ el'dut tnfsf uxf]x? / e0x? kfgl l5g{g; Sg]u/L agf0Psf]xg' kg5 / cfl; nfkkgf (Damp) nfo{/f\$gsf]lgldQ ; dt kof{t dfqdf Joj :yf ul/Psf]xg' kg5 .
- r_ el'dut tnfsf]lgldQ 566}af6f\$]Joj :yf xg' kg5 . Ps e6bf w})e/dfEx? ePsf]ejgdf o:tf] e/dfEn]g}el'dut tnf / dflyNnf]tnfx? alr ækifo/ ; k/zgÆ (Fire seperation) sf]sfd ug] u/L /flvPsf]xg' kg5 .

(=! != 5fgfsf]kfglsf]lgsf; sf]pkoQm Joj :yf xg' kg5 .

(=!@ Irldg (Chimney) - ; dtn 5fgf e6bf slDtdf)=(dl= dfly /xg]u/L Irldg agfpg' kg5 / ; w\$]kof/flk6 (Parapet) kvf{sf]prf0{e6bf sd xg] u/L agfpg' x56 . le/fnf] k/\$] 5fgf eP Irldg hxfÆ6 aflx/ lgl:sPsf]x65, 5fgfsf]To; efu e6bf Irldgsf]prf0{slDtdf klg)=^ dl= xg' kg5 .

(=!# ; ldf kvf{ (Boundry wall)

; ldf kvf{sf]lgldQ lgDg Joj :yf nfu"xg5 M

- s_ ; ldf kvf{ (Compound wall) sf]prf0{af6f\$]s}b|/yfaf6 a9ldf !=% dl xg' kg5 . :yfglo lgsfosf]:jLst lnP/ @=! dl= ; Dd prf0{ePsf]; ldf kvf{ nufpg ; lsg5 t/ o:tf]kvf{sf] dflyNnf])=^ dl= vhf lsl; dn]agfpg' kg5 .
- v_ dfly -s_ df pNn]vt Joj :yf h}hx?sf]lgldQ nfu" gxg] / cfBfl]us ejg lgdf0f, ljBt\; j :6zgx?, 6Æ; km/ :6zgx?, z}lfs ejgx? jf c6o ; fj h]lgs ?kdf kpf]u xg] ePdf :yfglo lgsfon]a9ldf @=\$ dl= ; Ddsf]prf0{nf0{:jLst lbg ; Sg5 .

(=!\$= 0gf/ (Well) - dflg; sf]pkof]usf]lgldQ jf 3/h' pkof]usf]lgldQ cfj Zos kfglsf] cfkl't{ug]p2]on] /flvg]0gf/ ; Da6wl Joj :yf lgDg cg; f/ xg5 M

- s_ sg]klg k\$]f/sf]kmf]x? kmfNg]jf hDdf ug]vfn8f]jf 7f5 - l/^oh lk6, lkld, ; s lk6, ; f\$]j jf]xf]h n]66 cflb _ af6 slDtdf klg !^ dl= 6f9f /xg]u/L / o:tf]7f5df e6bf dfly kg]u/L 0gf/ /flvg' kg5 .
- v_ aflx/af6 hfg]kfgln]0gf/sf]kfglnf0{blift kfg{gkfp]u/L 0gf/sf]:yfg to ug{kg5 .
- u_ 0gf/sf]leql Joj; (Diameter) slDtdf ! dl= sf]xg' kg5 .
- 3_ ?v dl] kg]eP 0gf/ dfly 9sg jf 5xf/L /flvg' kg5 .
- a_ hldgsf]; txaf6 slDtdf klg ! dl= sf]prf0{Dd uxf] nuf0Psf]xgkg5 / 0gf/sf]j l/kl/ slDtdf klg !=* dl= k/; Dd kfgl gl5g]; fdfullsf]kpf]u u/L To; dfly kg]kfgl 0gf/e6bf aflx/ axg]Joj :yf ldnf0Psf]xg' kg5 .
- r_ 0gf/sf]; a}efux? :yfol lsl; dn]lgdf0f ul/g' kg5 .
- 5_ hldgaf6 slDtdf klg !=* dl= sf]ulx/f0{Dd 0gf/sf]leql ; txnf0{kfgl gl5g]agf0g' kg5 .

(=!% ; K6s 6df5 (Septic Tank) - ejg lgdf0f ubf{; K6s 6df5 clgj fo{?kdf /flvg' kg5 .

(=!%!= :yfg (Location) - ; K6s 6df5 - hldg dl] agf0g]kmf]x? kfgl hDdf xg]jf ; f]g]lsl; dsf] c6o sg}Joj :yf _ vfg]kfglsf]>f] e6bf slDtdf klg !^ dl= 6f9f /xg' kg5 . dflg; x? a:g]3/ jf cfj f; e6bf ; ej eP; Dd k/ /flvg' kg5 .

(=!%=@ c6o Joj :yfx?M

- s_ ; K6 6df5sf]rf0{slDtdf &% ; dl= / o; sf]lfdtf (Liquid Capacity) slDtdf ! 3g dl6/ xg' kg5 . o; sf]ndaf0{rf0{e6bf b0{ugf bl]v \$ ugf ; Ddsf]xg' kg5 .

- v_ 06f, 9uf jf slɛmbáf/f lgdfɔf ug{; lsgɔ / o; nf0{kfgl gl5g}(Water-tight) agfpg' kgɔ .
- u_ ; ʃ6l 6ɔfɔaf6 lg:sg]kɪfɔf jf kɪfɔf kfglnf0{-kof(t dfqdf ; w/ gul/P ; Dd _ sg] klg vhf 9n jf gfnfx? jf kfgldf ld; fpg' xɔg .
- 3_ kf0ksf]Gɔɔtd Jof; !)) dl=dl= xg' kgɔ . dɔg xfh (mainhole) sf]kf0kx? ePsf] hS; g (Junction) df dVo kf0k; ɹ zfvf kf0kx?sf]sfɔf \$% l8ul eɔbf a9L gxg] lsl; daf6 /Vg' kgɔ .
- a_ kɔɔs ; ʃ6l 6ɔfɔsf]kfgl l; kɪh lk6 (Seepage pit) df hfg]ePsf]elɔ6nɔzg kf0k h8fg ul/Psf]xg' kgɔ . o:tf]kf0ksf]dflyNnf]efu hflnx?áf/f plrt tj /n]9flsPsf]xg' kgɔ . elɔ6nɔzg kf0k ejgsf]6k (Top) eɔbf @ dl= dfly; Dd nɪfg' kgɔ .
- r_ ; ʃ6l 6ɔfɔsf]kfgl æ; kɪh lk6 (Seepage pit) df hfg]ePdf o:tf]l; kɪh lk6sf]gfk slɔtdf () ; ɔdl= xg' kgɔ / o; sf]ulx/f0{æ0gnɔ kf0kÆ eɔbf slɔtdf !)) ; ɔdl= xg' kgɔ . o:tf]l; kɪh lk6 9uf, 06f jf slɛmbɔsf]Jnsaf6 kɪsf (Dry) ufxf]nufP/ agfpg' kgɔ / o:sf]k5fl8 slɔtdf &=% ; ɔdl= afSnf]v; f]lu6xl (Coarse aggregate) eg{kɔgɔ . 0gnɔ kf0k eɔbf dflysf]ufx]d; nf (Mortar) áf/f agf0Psf]xg' kgɔ . 0gnɔ kf0k dflysf]efu (Top) af6 () ; ɔdl= tn xg]u/l /Vg' kgɔ .

(=!^ e/ɔfɛ (Staircase)

(=!^!= e/ɔfɛsf]Gɔɔtd rɔf0{lgɔg cg; f/ xg' kgɔ M

- s_ cfj fl; o ej g -3/x?_ -)=(dl=
- v_ cfj fl; o -xfɔh ej gx?_ - !=% dl=
- u_ dflg; x? hɔdf xg]
- cl86f/od, gfr3/, l; gɔf 3/ cflb_ ej g - !=% dl=
- 3_ zɪfs ej g - !=% dl
- a_ ; ɹyfut ej g - @=) dl=
- r_ cɔo ej gx? - !=% dl

(=!^@= v8lɔnf (Tread) sf] rɔf0{- cfj fl; o ej gx?sf] nflu v8lɔnfsf] rɔf0{#@ ; ɔdl= / cɔo ej gx?sf]nflu #) ; ɔdl= eɔbf sd xg' xɔg .

(=!^#= v8lɔnfsf] prf0{ (Riser) - cfj fl; o ej gx?sf] nflu v8lɔnfsf] prf0{!(; ɔdl = / cɔo ej gx?sf]nflu !% ; ɔdl= eɔbf a9L xg' xɔg . e/ɔfɛsf]kɔɔs r9f0 (Flight) df !% j 6f; Dd dfq v8lɔnfx? /Vg' kgɔ .

!)= ej g jf lgdfɔf?df d'; f / cɔo lɔ/fx? (Termite) lgoɔqɔf ug{kɔg}

!)=! x/ɔ ejgsf]husf]ufx]l j rdf g66ɔsf] (Continious) xgkgɔ / e0{kfg d'; f hfg g; Sg]u/l kSsf lsl; dn]agf0Psf]xg' kgɔ .

!)=@ ejgdf sb}kɔf/sf]d'; f k:g ; Sg]vNnf jf vfnl efux? -hu, e0{emɔfn, gfnl cflb_ nf0{lɔ t /fd/l aɔb ul/Psf]xg' kgɔ, lɔ t hfnl -jf luɪ_ xfn] d'; f hfg g; Sg]agfpg' kgɔ .

!)=# x/ɔ ejgdf lɔ/fx? (Termite) a:g g; Sg]Joj :yf ldnf0Psf]xg' kgɔ .

!!= kɔfz / elɔ6nɔzg

!!!= sf7fx?df k\$z / e6nžgsf]lgldQ aflx/L xj f cpg]u/L vh\$]j f vhf a/08f lt/ vh\$]Ps j f w]}vhf efu (Opening) x? xg' kg\$.

!!=@= vhf efu (Opening) e0\$]^ efusf]Ps efu a/fa/sf]efu xg' kg\$.

gf\$ M != em\fn cflzs ?kdf vfl]g ldNg](Partially Fixed) ePdf, vfl]g ldNg]lfqkmmnf0{ ; dfj ž ul/g]5 .

gf\$ M @= sg}klg sf7f k\$zsf]nflu eg] 56df0Psf]vhf efua6 &=% dl= e6bf 6f9f ePdf To:tf]sf7fnf0{k\$zsf]JoJ :yf ePsf]dflgg]5\$.

gf\$ M #- efc; fsf]lgldQ dfly -s_ / -v_ df pln\ ePsf]vhf efu (Opening) Sf] lfqkmmnf @% kl|zttn]a[4 ug{kg\$. - xg'kf] abf g#=# _

!@= In^6 ; Da6WL JoJ :yf M-

!& dl= e6bf a9L prf0{ePsf]ej gdf In^6sf]JoJ :yf ug{kg\$. In^6 ; Da6WL c6o JoJ :yf National Building Code cg' f/ xg\$.

!#= r6dfE (Lightening) lgo6q0f ; Da6WL JoJ :yf

sg}ej gx?sf]prf0{j f cj l:yltsf]sf/0fn]r6dfEsf] ; e]j gf xg]ej gx? , ; fj h]gs dxTj sf ej gx? tyf dxTj k0f{ej gx?df r6dfE lgo6q0f ; Da6WL JoJ :yf ul/Psf]xg' kg\$.

!\$= Void sf] ; f0h M-

Void sf] ; f0h !=% dl x !=% dl= ; Dd ePdf Void uf|p08 se/hdf u0fgf xg]5\$. ; f]e6bf ; fg]Void ePdf uf|p08 se/hdf u0fgf xg\$.

!%= PkmP=cf/= (FAR) df u0fgf gxg]cj :yf M-

!%=!= kflsE kpf]hg jf Storage sf]nflu kpf]u xg]eldut tNnf (Basement) cw{eldut tNnf (Semi Basement) tNnf? FAR df u0fgf xg]5\$.

!%=@= e0f-tNnf (Ground Floor) kflsEsf]nflu dfq kpf]u xg]ePdf / ; f]xl cg' f/ vNnf /x\$]cj :yfdf FAR df u0fgf xg]5\$.

!%=#= 5fgf dfly lgdf0f xg]e-ofE, In^6sf]d]zg sf7f, kfgl 6dfEsl cflbn]cf]u6\$]efu FAR df u0fgf ul/g]5\$.

!^= ejgsf]prf0{M-

ejgsf]prf0{kkn6y n6n b]v dflyNnf]tNnf -e/dfE_ 5f]g]j f In^6 (Lift) sf]d] ; g /Vg]sf7f afx\$]sf] 5fgf (Stope) ; Ddsf]prf0{ulg\$.

!&= gkfnl jf :t\$nf emNsg]ej g lgdf0f M-

k/Dk/fut cyj f kl/df]h{ ?ksf]gkfnl jf :t\$nf emNsg]ej g lgdf0f ubf{ ; flj sss] FAR df)=@% yk ; lj wf k|t xg]5 t/ of] ; lj wf k|lrg :df/s lfqdf nfu"xg]5\$.

kl/R5b @

sf7df8fjdxfgu/kfnsf, nln tk' pkdxfgu/kfnsf, slitk' gu/kfnsf / gu/fldv

uf=j ; = df ul/g]lgdf ; DaGwl dfkb08

kl/R5b @

sf7df8f)pkTosfdf e0{x\$}f]zx/ls/0fnf0{Jojl:yt ug{xfn e0{x\$}f]/ kl5 xg]lgdf0f sfo{x? ; lgo]lht tyf of]hgfa4 tl/sfn] ; DkGg ug[u/fpg]qmdf sf7df8f)dxfgu/kfnsf, nln tk/ pkdxfgu/kfnsf, slt k/gu/kfnsf tyf gu/f]dV uf=j =; = lfnf0{ tn p]n]vt lfnx?df lj efhg u/L lgdf0f ; DaGwl dfkb08 ; d] lgwf0f ul/Psf]5 .

- != k/fgf]zx/L lfn (Cultural Heritage Conservation Zone)
- @= cfj fl; o lfn (Residential Zone)
- #= ; :yfut lfn (Institutional Zone)
- \$= cfBfl]us lfn (Industrial Zone)
- %= ; A]f0f lfn (Preserved Zone) -kfs{ jg, xl/ofnl, vNnf lfn, P]txfl; s, ; f:s[ts tyf wld\$ lfn cflb_ .
- ^= zx/ lj :tf/ lfn (Urban Expansion Zone)
- &= ; tx ; j f/L lfn (Surface Vehicle Zone)
- *= lj dfg:yn lfn (Airport Zone)
- (= v]hsb lfn (Sport Zone)

!= k/fgf]zx/L lfn M o; lfnf0{:yfgsf]k\$[t x]L lgDg adf]hd # pklfn]df lj eflht ul/Psf]5M

- s_ ; A]ft :df/s pklfn (Preserved Monument Sub-Zone)
- v_ ; A]ft pklfn (Preserved Cultural Heritage Sub-Zone)
- u_ ldl>t k/fgf]j ; j]f; pklfn (Mixed old Residential Sub-Zone)

; fy}o; lfn tyf pklfnx?nf0{g\$; df b]f0Psf]5 .

-s_ ; A]ft :df/s pklfn M

o; ; A]ft :df/s pklfn leq lj leGg k/ftfl]s tyf P]txfl; s dx]jsf j xfn, j]xn, dlGb/ tyf b/j f/ :Sj fo/ cflb kg[xBf o; pklfn]sf P]txfl; s ; f:s[ts Pj +j f:tsnfut jftfj/0fdf kl]tsh c; / gkg]ul/, kf/Dkfl/s j f:tsnfsf]b?kof]u gxg]ul/ ; DalGwt lgsfon]lgDg j df]hd :jLst lbg ; Sg\$. ; A]ft :df/s lfnx?df gofF3/ j f ejg lgdf0f ug[cyj f dd\$; wf/ ug{rflxg]JolQm j f ; :yfn]; f]3/ j f ejgsf]o; }dfkb08 Pj +gb]zsf j df]hdsf]z]nl Pj +cfsf/ k\$[f/sf]g\$; f ; DalGwt lgsfoaf6 :jLst u/f0{dfq j g]pg kf0g\$.

o; pklfn]sf lgdf0f xg]3/ j f ejgx?sf]dfkb08 lgDgfg; f/ xg\$ M

!= o; pklfn]df algg]3/x? k/Dk/fut g]kfnl z]h]lsf]xg' kg\$ - z]h] kl/R5b ^ sf]cg; l'rdf b]fP cg; f/ xg\$ _ .

o; pklfn]sf]nflu clwstd uf]p08 se/h, clwstd tNnf / prf0\$]; fy}^nf] P]of /l]; of] lgDgfg; f/ tfl]sPsf]5 .

3/ agfpg]7fpF	clwstd uf]p08 se/h	clwstd prf0{	clwstd tnf	clwstd FAR
vfnl 7fpF ; d]df agfpg k/fgf] 3/n] rr\$]f] 7fpE]f k/fgf]3/ e]sf0{agfpg].	*) kl]tzt !) kl]tzt -k/fgf] 3/n] rr\$]f] lfn]km a/fj / _	##% lkm6 ##% lkm6	\$ \$	#= #=%

- @ dd{ ug{rfxg}h}k{/fgf]3/sf]lj :t{ gS; f agf0{3/sf]dfx}8fsf]km}6f]; d{ clgj fo{?kdf k}z ug{kg}5 . 3/sf]prf0}h}j l/kl/sf]jftfj /0fnf0{k|tsh c; / gkg}ePdf ; 8s tkm}sf]dfx}8fsf]prf0{ nf0gsf k{/fgf k/Dk/fut z}hlsf 3/x?sf]nf0g; E ldNg]ul/ clwstd prf0{#% lkm}6 eGb a9L gxg]u/L :jLst lbg ; lsg}5 . 3/sf]prf0{ ; 8ssf]s}b{/v}fsf]; tx blv u0fgf ul/g}5 .
- #= e0{blv e0{Dd - Ps tNnf _ sf]prf0{a9Ldf * lkm}6 ; Ddsf]/ j0un ; d{ rf/ tnf ul/ clwstd prf0{ #% lkm}6 -!)-& ld6/_ ug{ ; lsg}5 . t/ gofFlgdf}0f xg]3/; E sg}P}t}xfi; s Pj +j f:t}snfsf bl}6sf}0fn] dxTj k0f{:df/s /x}5 / ; f}7fp}df #% lkm}6 prf0}df 3/ lgdf}0f ubf{; f]:df/snf0{k|tsh c; / kg}blvPdf #% lkm}6sf]prf0}df lgdf}0f ug{:jLst lb0g]5} / :df/ssf]prf0{eGb xf}f]xg]/ :df/snf0{k|tsg c; / gkg}ul/s}g dfq lgdf}0f ug{kfp}g}5 .
- \$= k/Dk/fut snf tyf jf:t}snfsf]bl}6n]; Af0f ug{k}g}v}nsf]k{/fgf]3/nf0{e}tsf0{k}g}M lgdf}0f tyf dd{ ubf{; flj s 3/ adf}hd dfq lgdf}0f sfo{ug{kf0}65 . t/ ; 8s tyf ; fj h}lgs :yn tkm{kfnl lgsfn}5f] /x}5 eg]gofFlgdf}0f ubf{; f}kfnln]cf}u6}sf]hldg; ; 8s jf ; fj h}lgs h}Uffnf0{; fj h}lgs k}p}h}gsf]nflu 5f8l dfq lgdf}0f ug{kfp}g}5 .
- %= l; d}6 r}gf cflb /fvL knfi6/ gu/L 3/sf]j flx/L efusf]uf/f}0f k}6; E blv}g]ul/ 0}6fsf]uf/f]nufpg' kg}5 . aflx/af6 blv}g]ul/ cf/} ; } ; = / :6ln k}d :6&r/ ej g lgdf}0f ug{kf0g]5} . aflx/L efuj f6 cf/= l; } ; = jf :6ln k}d :6&r/ gb}lv}g]ul/ g}kfnl snf}ds 9}af6 0}6f jf sf7n]5f}kl cf/= l; } ; = / :6ln k}d :6&r/df ej g agfpg kfp}g}5 .
- ^= t} f}tNffdfly cf^g}h}l}ufdf kg}ul/ # lkm}6 rf}8f0{; Ddsf]an]L jf kfvf lgsfNg kf0g}5 .
- &= %ofn 9f}5fx? sf7sf]xg' kg}5 / pQm %ofn 9f}5fsf]rf}8f0{/ prf0{k/Dk/fut g}kfnl z}h}l Pj +cfsf/ k}5f/sf]xg' kg}5 .
a0undf k/Dk/fut %ofnx? /fVg ; lsg}5 . xgdfg9f}5f b/jf/sf]sDkfp08 k}5L sg}k}5f/sf %ofnx? tyf kf0k cflb blv}g]ul/ /fVg :jLst lb0g]5} . 9f}5fdf vf}kfx? sf7sf xg' kg}5 . kmfd]/f}h}u ; 6/ /fVg kf0g]5} .
- *= d7 dl6b/ afx}5 ; j {fwf/0fsf]3/sf]5fgf k/Dk/fut g}kfnl z}h}lsf]b0{kfv]5fgf xg' kg}5 . t/ lgdf}0f xg] 3/ h}l}ufsf]ltg}lt/ c? s}3/n]3}5f]ePdf ; 8s kl}5 Ps kfv]5fgf /fVg cgd}tl lbg ; lsg}5 . o; pk}l}q}df lem}u6l jf c6o df6f}5f]6fonn]@%o blv #%+; Ddsf]:nf}k}df 5fgf 5fpg kg}5 . 5fgdf ; fwf jf snf}ds 6}8fn /fVg ; lsg}5 .
- (= clwtd prf0{lgdf}0f ug}ePdf cl}td -rf}yf] tnfdf 5fgf}sf} # v08sf]! v08 a/fa/; Ddsf]sf]L agfpg ; lsg}5 . t/ xgdfg9f}5f b/jf/ / kf6g b/jf/ :Sj fo/sf]sDkfp08 tkm{sf}L /fVg kf0g]5} . lj z}f kl/l:y}l}tdf ; Dal}wt lj z}f1 ; lxtsf]; ldltsf]/fo ln0{gu/kf}l}nsf]sf}lsf]lf}q}k}m}df yk36 xg]ul/ sf}L /fVg lbg jf glbg kl}g ; Sg}5 .
- !)= cf^g}h}l}uf dfly ; fdf}6otf t} f}t}nfdf sf7sf]j fb}h}L agfpg ; lsg}5 .
- !!= 3/sf]sfg} k}l}o}5 tnf 5l6g]ul/ a9Ldf (0}6r ; Dd ufx}5f]; tx eGb -k}f}h}5; g_ aflx/ lgsfnl /fVg' kg}5 .
- !@= cf^g}h}l}ufdf l5d}5Lsf]3/; E ldNg]ul/ !-! @-k}m}6 prf0{/ @ lkm}6; Ddsf]rf}8f0{sf]k}5L agfpg ; lsg}5 .
- !#= lS}Qf g}kl gS; fdf b}v}f0Psf]xfn e}v}5f]rf}5nf0{oyfj t /fVg' kg}5 / ; flj s rf}5sf]; Da4}6 / ; Af0f ug} sfo{rf}5 pkef}ustf}5f]xg}5 / rf}5df c6o sg}k}5f/sf]lgdf}0f sfo{ug{kf0g]5} ; fy}rf}5df Sof6ln}e/, sf}7f, j fb}h}L lgsfNg kf0g]5} .

!\$= 3/sf]krfx/ dñf / lgdf0f kl5sf lgdf0fsf krfx/ dñf :yfglo lgsfo j f krfx/ dñf Joj :yfg ug{lgsfon] tf\$}f]7fp0f dfq ^ofSg' kg\$. ; fj flgs af6f] k0L, uNnl, rf\$df l5d\$ / ; j {fwf/0fnf0{jfwf kg{lul/ lgdf0f ; fdulx? ykfg{kf0g]5g .

!%= o; pklfq leq ; /sf/L, cw{ ; /sf/L j f u} ; /sf/L ; :yfgx?af6 ul/g] sg}klg s0fsnfk -af6f] 9n, lahl, 6l]nkrfq cflb_ ; DalGwt lgsfox? sfofj og ; ldt, :yfglo lgsfo / k/ftTj lj efua6 :jLst Ing' kg\$.

!^= klxn]g]lgdf0f e0; s\$}f]cfwgs cfsf/ k\$}f/sf 3/ tyf ejgx?sf]tnf ykg]tyf dd\$ ugI; DaGwdf dfly pNnl]vt dfkb08 adf]hd tof/ xg]ul/ kgM yk lgdf0f ul/ dfq :jLstL lb0g]5 .

!&= k/Dk/fut gkfnl zñlsf / /f0ffsflng zñlsf ; flj ssf 3/ ejgx? ; fxl cg?k ; flj s zñlnf0{sfod /vL dd\$ / kgM lgdf0f ug{k\$.

!*= o; lfd\$ sf}k\$}f/sf krf{kf]6/, Aofg/ cflb 6fFg j f /Vg kf0g]5g .

!(= o; pklfq leqsf ejgx? eTsfpg' kb{k/ftTj lj efusf]:jLstL Ing' kg\$.

@)= o; pklfqdf lgDg pkofu lgifv ul/Psf]5 M-

- wld\$, ; f:s[ts tyf eflts jftj /0fnf0{kltsh j f blift kfgIc6o s0fsnfkx? ug{
- clgl, klj nglzn kbfi{h:t}M uof, ; k0f, bfp/f, sf0nf, dl\$th / lj :krf\$ tyf /f; folgs kbfi{Jofkfl/s bl\$sf0faf6 ; #o / lj qml lj t/0f ug{
- Jofkfl/s bl\$sf0faf6 lel8of]k0z0 ug{
- lgdf0f ; fdulx? h:t}Ml; d06, 06f, 58, h:tf-kftf cflbsf]k; n /Vg,
- tf]sPsf]7fpFafx\$ c6o 7fp0f 3Dtl j f :yfol t/sf/L k; n /Vg,
- sf#f]df5f, df; 'a]g]k; n tyf ; f0sn, df0/; f0sn, df0/, 7hf cflb dd\$ ugI;k; n /Vg,
- luh j f j N8# ; DaGwl pBfu j f j s\$z k ; -rfng ug{
- sv/f, xF j f rfkfof -uf0{e}L, j #/ cflb_ kfng pBfu ; -rfng ug{

@!= o; pklfqdf c?sf]3/nf0{c; / gkgI tyf j l/kl/sf :df/s, wf/fsf]dxfg cflbnf0{kltsh c; / gkgIul/ j] d06, ; dj } d06 j gfpq :jLstL lbg ; lsg\$.

@@= o; pklfqsf]lj z]ftdf kltsh c; / gkgI lsl; dsf cfj f; lo / cfj f; lo ; DalGwt Jofkfl/s, lznksnf, wld\$ / ; f:s[ts pkofu{x?sf]nflu cgd tl lbg ; Sg\$.

-v_ ; Aift pklfq M-

o; pklfq leq gS; df b]vP adf]hd k/Dk/fb]v P]txfl; s lj sf; qmddf lj sf; x\$}cfPsf]k/fgf zñlsf zx/ -cj 0 Sof/\$6/_ em]sfpg]vfnsf af6f]?, rf\$ x? / To:tf af6f] rf\$; E hf]8Psf l\$Qdf ag\$}f ejgx? / k/Dk/fut zñlsf 3/, ejgx?, dl6b/x? cflb kb\$g\

ol af6f] / rf\$ x?sf]7fpF7fp0f ; f:s[ts tyf wld\$:ynx? k/Dk/fut zñlsf sxl gkfnl 3/x? cem] af\$ /x\$}f x\$}f o; pklfq leqsf ol k/fgf cj 0 Sof/\$6/_ em]sfpg]j:f:t\$nf / ; f:s[ts tyf wld\$:ynx?sf] ; fy}k/Dk/fut zñlsf egf{sh/ j f:t\$nf0{; Aif0f ; Dj 40df kltsh c; / gkgIul/ ; DalGwt lgsfon]lgDg adf]hd :jLstL lbg ; Sg\$ M-

!= o; pklfqdf vfnl hUff; d]df agf0g]ejgsf]clwstd u]p08 se/h *) kltzt, Ps cfgf; Ddsf]vfnl hUufdf ; tkltzt / k/fgf]ejg eTsf0{agfpg\$}xsdf k/fgf]ejgn]rr\$}f ; Dk0f{lfdkmm a/fj / xg\$. k/fgf] 3/ j f ejg eTsf0{gofF3/ agfpg gofFdd\$ ug{rfxg] k/fgf] 3/sf]lj :t\$ gS; f / 3/sf]dfx8f?sf]krf\$}f; d] clgj fo{kdf k\$ ug{k\$.

- @= 3/sf]clwstd tnf kf# tyf clwstd prf0{\$% lkm6 -!#& ld= e%of^a 5f]g]; lxt_ ug{; lsg] 5 . clwstd ^nf] xf06 @=\$) ld= - * lkm6 _ xg' kg\$. o; pklf]df agfpg kf0g]clwstd FAR #=&% xg\$. k'/fgf]3/n]rr\$]7fp]df agfpg\$]xsdf k'/fgf]3/n]rr\$]lfg]kmmnf0{hluufs]lfg]kmm dfgl FAR \$=% sfod ul/g\$.
- #= 3/sf]prf0h]j l/kl/sf]j ftfj /0fnf0{c; / kg]ePdf ; 8s tkn\$]df]8fsf]prf0{nf0gdf c? k/Dk/fut g]kfnl z]hlsf 3/x?sf nf0g; E ldNg]ul/ :jls[t lbg ; lsg\$. t/ o; f]ubf{clwstd prf0{\$% lkm6 - !#& ld6/_ eGb f a9L xg]5g . snf, jf:t'snf Pj +wld\$ bl]6sf]af6 dx]j k0f{/x\$]7fp]df eg]:df/s jf :df/ssf]sDkfp08sf]j l/kl/sf klxnf]klQmsf 3/x? :df/seGb f x]f]xg]u/L lgdf]df ug{kg\$.
- \$= aflx/L uf-xf]df l; d]6 knfi6/ gu/L ; 8s tkn\$]df]8fsf]lknlg]; usf] xsdf -Fair Face Brickwork_ k]6; E 0df b]vfp]g]vfnsf]uf-xf]nufpg' kg\$. t/ :tk j l/kl/sf 3/x?df eg]; Vvf rgf, knfi6/ ug{klg ; lsg\$.
- %= lsQf gfl g\$; df b]v]0Psf]/ xfn e0{x\$]rf\$nf0{oyfj t /Vg' kg\$. ; flj s rf\$sf]; Alf] / ; Da4g xg] sfo{afx\$ c6o sg}klg k\$]f/sf] 6x/f, kvf] cflb lgdf]df ug{kf0g] 5g . rf\$ dfly kg]ul/ Sof6Ln\$/, j b]h, sf]f, cflb lgsflg kf0g]5g . rf\$sf]k]lnf0{rf\$}lx:; f dflgg\$.
- ^= af6f]jf rf\$ k\$] b]vg]efudf :nf]k 5fgf g}xg' kg\$.
- &= clwstd prf0{Ddf lgdf]df ug]ePdf cl]td tndf 5fgfsf]## kl]tzt lfg]kmm j /fj /; Ddfsf]sf]L agfpg ; lsg\$ / b0]j f Ps kv]5fgf xg' kg\$.
- *= cf^g]hlu f dfly ; fdf]otof t] fl]tnfdf sf7sf]j b]h agfpg ; lsg\$.
- (= k/Dk/fut g]kfnl z]h] Pj +cfsf/ k\$]f/sf sf7sf %ofnx? /Vg' kg\$.
- !)= k/Dk/fut g]kfnl z]h] Pj +cfsf/ k\$]f/sf sf7sf vkf ePsf]9f]f j f k; nsf sj ndf sf7df vkf /vl agfpg' kg\$. k; nsf sj nx?df /fl]n# ; 6/ /Vg rfxgh]uf/f\$]af]x/ k6L /fl]n# ; 6/sf]sg}klg efu gb]vg]ul/ /Vg' kg\$ j f /fl]n# ; 6/nf0{5f]kg]ul/ sf7sf vkf]x? klg /Vg ; lsg\$. o; pklf]df klg ; Alf] :df/s pklf]df lgin] ul/Psf s]fsnfkx? ug{kf0g]5g .
- !!= o; pklf]df c?sf]3/nf0{c; / gkg]tyf j l/kl/sf]:df/s, 9u]v/f]sf]dxfg cflbnf0{kl]tsh c; / gkg] ul/ j] d]6, ; l]j] d]6 agfpg :jls[t lbg ; lsg\$.
- !@= o; pklf]df ePsf k'/fgf 3/x? e]sfpg :yfglo lgsfosf]:jls[t lng' kg\$.
- u_ ldl>t k'/fgf]j ; f]f; pklf]df #
k'/fgf]zx/L lfg]df kg]; Alf] :df/s pklf]df, ; Alf] pklf]df eGb aflx/sf]; a}efu o; }c]t]t kb\$g\ . j ; f]f; tyf ; f] E ; DalGwt s]fsnfksf]nflu pknAw ; j]f ; l]wfsf]cfwf/df hg3g]j lgo6q]df ug{o; pklf]df lg]dg cg' f/ xg]ul/ 3/ j f ejg agfpg :jls[t lbg ; lsg\$.
- != o; pklf]df kg]vfnl hlu f ; d]df ag]ejgsf]clwstd uf]p08 se/h *) kl]tzt, Ps cfgf; Ddsf] vfnl hlu f ; tk]tzt / k'/fgf]ej g e]sf0{agfpg\$]xsdf k'/fgf]ej gn]rr\$]lfg]kmm a/fj / kf0g\$.
- @= o; pklf]df ag]ejgsf]clwstd tnf % -kfF_ tyf prf0{\$% lkm6 -!#& ld= agfpg ; lsg\$. ; a} eGb dflyNnf]tnfsf]5fgdf hfg]e%of^a 5f]g]efu a9Ldf & lkm6 ^ 0Gr clnf]efu / To; dfly kf/fk\$ # lkm6 5b lbg ; lsg\$. o; pklf]df]vfnl 7fpF; d]df agfpg\$]xsdf FAR \$ / k'/fgf]3/n]rr\$]7fp]df agfpg kfg]clwstd FAR \$=% xg\$.

#= o; pklfndf lgdfnf ul/gjl; gdf xn, lyP6/, ; k/dfs, Jofkl/s sDkn\$; cflbsf]clwstd ufip08 se/h
) kltzt; Ddf xg ; Sg\$. kfls[sf]nflu Gogtd kn6sf]!% kltzt ; Ddf hluf /Vg' kg\$. prf0\$]f
xsdf clwstd !#-& ld6/ e6bf a9L xg]5g / FAR @-% xg]5 .

\$= 3/af6 lg:sg] kmf/ dnf :yfglo lgsfo jf kmf/ dnf Joj:yfkg ug; DaGwl ; :yfn] tf\$] adf]hdsf]
7fpdf ^ofSg' kg\$. lgdfnf ; fdul ; fj hlgS af6] kpl, rf\$, uNfl cflbdf /Vg kf0g]5g .

%= o; pklfndf ag]ejgsf]5fgf dfly kg]j iff[sf]kfgl kf0kaf/f hldg tNnf ; Ddf Nofpg' kg\$.

^= o; pklfndf kg]lsQf gkl gS; fdf byf0Psf ; flj s rf\$? oyfj t /Vg' kg\$. ; flj ssf ; fj hlgS tyf
lghl rf\$]f; Da4g / ; Af0f xg] s6fsnfk afx\$ c6o sg]sl; dsf]lgdfnf rf\$ leq ug{kf0g]5g .
; fj hlgS ; 8s -af6] jf rf\$ dfly kg]ul/ Sof6ln6/, j flsf]L, sfyf / 3/ cuf8lsf]l; 9L cflb agfpg
kf0g]5g . rf\$]f]k6lnf0{rf\$}ix.; f dflgg\$.

&= o; pklfndf snf]ds jf:tsnfsf]b[6n]clt dxTj /Vg]vfnsf]dfx8f ePsf]sg}ejg ePdf / ; DaGwl
j8f sfonofaf6 ; Af0f ug{kgl egl n]v cfpdf To:tf ejgsf] ; flj s dfx8fnf0{e]sfpg / ljuf/L efu
j08f, j j ljvg ul/ gofFeg agfpg kf0g]5g . ; flj s dfx8f oyfj t sfod /xg]ul/ dd\$; wf/ / kgM
lgdfnf ug{lb0g\$. j8faf6 To:tf ejgx?sf] nut tof/ kf/L /Vg' kg] / To:tf ejgsf] 3/ wglSf]
j]f:tfaf6 lflt xg]cfzsf ePdf plrt lfltkl't{lb0{gu/kflnsfn]vl/b ug{; Sg\$.

*= o; pklfndf lgDg pBfux? lgifw ul/Psf]5 M

- sV/f tyf rffkof kng ug{
- 3/ agfpg 18:sjfnf sf7lrg]dl; g afx\$; -ldn tyf sf6 lrg]dl; g kofu ug{
- jftj /of blift jf kltsh c; / kg]s6fsnfkx? ; -rfng ug{
- cToflws Hj ngl; n kbfy{h:t}- llof; , k6h / c6o /f; folgs kbfy\$]e08f/ ug{.

@= cfjf; lo lfg M- cfjf; lo lfg eGgn]dVotM cfjf; sf]lgldQ kofu ePsf]lfnf0{hgfp55 . Joj l:yt ?kdf
hg3g]j a9fpb}hfg]o; cfjf; lo lfgsf]p27o /x\$]5 . o; lfnf0{:yfgsf]k\$[t x]L lgDg adf]hd \$
pklfndf x?df lj eflht ul/Psf]5 . o; lfg jf cGt[tsf pklfndf x?nf0{gS; fdf byf0Psf]5 .

- s_ Jofkl/s pklfndf (Commercial Sub- Zone)
- v_ jfSnf]ldl>t a; fjf; pklfndf (Densed Mixed Residential Sub-Zone)
- u_ c6o cfjf; lo pklfndf (Other Residential Sub-Zone)
- 3_ of]hgj 4 cfjf; lo pklfndf (Planned Residential Sub-Zone)

-s_ Jofkl/s pklfndf M

cfjf; lfg cGt[ut kv vb] tyf yf\$ Jofkl/ xg]!\$ ld6/ jf ; fj e6bf a9L rf8f0{ePsf km6kysf]
Joj:yf ePsf ; j}; 8s, /fhdfu{ lj z]f ; 8s, rqnky cflb ; 8s dfu{ # hf]8Psf lsQfx? / tl ; 8s 5]paf6
@% dl6/ ulx/f0{; Ddsf bf6f af6fsf lsQfx?sf lfgx? kb\$g\ lgDg lnvt lfgx? o; pklfndf leq kg]5gM

- dx/fhu# rqnkysf]qnl; #sf]s[6] /yfaf6 k] {!#% ld6/ / klZrd !)(ld6/ leqsf]/f06 ckm j] ; 8s
s[6] /yf blv bj}tkm{!% ld6/ sfod ePsf]lfg .
- rqnkysf]rfj lxn rf\$af6 ufzfnf rf\$; Ddfsf]lfgdf ; 8s s[6] /yf /f06 ckm j]!! ld6/ sfod ePsf]lfg .
- rqnky sf\$Zj / qnl; #sf]s[6]af6 pQ/ tkm{rqnkysf]klZrd #) # ld6/ leqs} /yf blv /f06 ckm j]!%
ld6/ sfod ePsf]lfg .
- rqnky snsl:yfg, rf/ bf6f6] sfndf6L, lj iofdtl kh x6]lqk/Zj / yfkfynl, sk08fjh, kNrf\$, hfj nfvjh,
nugv]h blv rqnky ; ftf6f6] Ddf .
- ufzfnf rf\$af6 k/fgf]afgZj / rf\$; Ddf .

- /Tgkfs{/ j fuj hf/sf]rfaf6f]b]v j fuj hf/, l8Nnl ahf/, wf]L vf]hfsf]kh, k'/fgf]afgZj / afudtIsf]kh xB}l; gfdun; Ddf .
 - rfj lxn rf\$ b]v j f] xB}uf\$0f{kfs\$sf]u\$; Dd .
 - cd]t ; f0G; SofDk; cufl8sf]af6f]b]v ; f]v\$]xB}gofFahf/af6 l/w/f\$ xB}afnfh'sf]dflyNnf]ahf/ ; Dd -j f0kf; /f\$]qml; #; Ddf_ .
 - l8Nnl j hf/ -kx/L kf]6sf]ltg rfa6f] af6 rf/vfn c88f, 1fgZj / rf\$ xB}gS; fn euj tl j xfn; Ddf .
 - nfhDkf6, lzt n lgj f; xB}rqmky qml; #; Dd .
 - rqmky; # hf]8Psf lsQfx? .
 - c/lgsf]/fhdfu{yfkfynl df0tl3/ b]v tlgs\$] Dd .
 - df0tl3/ b]v /fdzfx ky, k'tnl; 8s, sdnfbl xB}hogkfn l; gdf3/; Dd .
 - b/j f/dfu{tlgwf/f kf7zfnf, sdnfbl, s[0f kfp/f\$], 1fgZj /, /ftfkh xB}ufzfnf rf\$; Dd .
 - zvdh, gofFafgZj / rf\$, k'/fgf]afgZj / xB}ufzfnf; Dd .
 - lqk'Zj /, ; Gwf/f, /Tgkfs{ sflctky, ngrf], dx/fhuh rqmky xB}af; j f/l; Dd .
 - sfnldf6L, shZj /, aNv' xB}lq=j = u\$; Dd .
 - lj /b]cgt/f]60 ; Dd]hg s]b\$]j l/k]sf]; 8s .
 - l; xb/j f/ kvfn j l/k]sf]; 8s .
 - cgfdgu/, xgdfg:yfg, lahhlahf/ xB}gofFafgZj /; Dd .
 - ef6e6\$], afn] f6f/ xB}dx/f/huh; Dd .
 - ef6e6\$], lj zfnгу / xB}rqmky; Dd .
 - 1fgZj / rf\$b]v e]j :yfg dlGb/ xB}; fgf]uf] /0fsf]ltg bfa6f] Dd .
 - 1fgZj /, d]lblj, tlг bfa6f]b]v d]lbl]L dlGb/ xB}l8Nnlahf/ ; 8s rf\$; Dd .
 - gf/fo0flx6L b/af/sf] pQ/ k]L{k'vfn(sf] #))l-)æ k] {b]v u]ll wf/f xB}kln; Sj f6/ 5]psf] pQ/ k]L{ s\$; Dd .
- ! = dfyl pNnl]vt ; 8sx?sf]bfofFj fofBf]hUffx?sf]; 8s l; dfgaf6 ; 8sx?sf]@% ld6/; Dd of]pklfq leq k/\$]df]gg\$. o; pklfqdf ejgsf]clwstdf uf]p08 se/h, clwstd FAR / clwstd prf0{lgDg adf]hd xg\$ #

l; = g+	ej gsf]lsl; d	hUffsf]lfqkm	clwstd uifp08	clwstd PkmP=cf/ -FAR_	clwstd prf0{
!=	Jofkfl/s sd cfj f; lo ej g	b0 cfgf b0k} f b]v * cfgf; Ddf	&) k tzt	#=)	tnlrqdf b]vfp adfl]nd Light Plane nf0{ g5\$g]ul/sg agfpg kfpq\$.
@=	£	* cfgfeGbf a9L	%) k tzt	#=)	
#=	:sh Sofdk;		\$) k tzt	@=)	
\$=	; /sf/l j f cw{ /sf/l sfoffho		%) k tzt	@=%	
%=	l; gdf xn,lyP6/ ; ef u\$		\$) k tzt	@=%	
^=	ko6g dGqnoaf6 tf\$]tf/]xf]h		\$) k tzt	@=%	
&=	Jofkfl/s sDkn\$; h:t}; k/dfs] cflb		%) k tzt	@=%	

@= 7hf Jofkfl/s Pj +cf]us ej gx?sf]xsdf @))) j u{lkmb eGbf a9L lknGy ePsf]ej gdf el'dut kfls£
(Under ground parking) sf]clgj fo{Jo: yf xg' kg\$.

#= ; 8s 5]psf] hlufdf Gogtd ! ld6/ ; Jofs 5f8L dfq lgdf] ug{kf0g\$. o; /L Gogtd ; Jofs 5f8L
3/ agfpg] Light Plane nf0{g5\$g]ul/sg agfpg kfpq\$. Light Plane nf0{g5\$g]ul/ agfpgnf0{
Gogtd ; Jofs 5f8L agf0g] 3/sf] prf0{b0{u0ff -; 8ssf] rf\$nf0{+ @ ld= a/fa/ xg\$. 3/x?sf]
nf0gdf /x\$]lj rsf]vfnl hlufdf agfpg ; Jofs gkUklg R.O.W. klq]ePdf c? 3/sf]nf0g; £ ldNg]
ul/ agfpg lbg ; lsg\$.

\$= :sh, Sofdk; , l; gdf xn, lyP6/ , ; ef u\$, xf]h tyf ; k/dfs] h:tf Aofkfl/s sDkn\$; agfpgsf] nflu
Gogtd hluufs]lfqkm # - ltg _ /fkgl xg' kg\$.

Light Plane

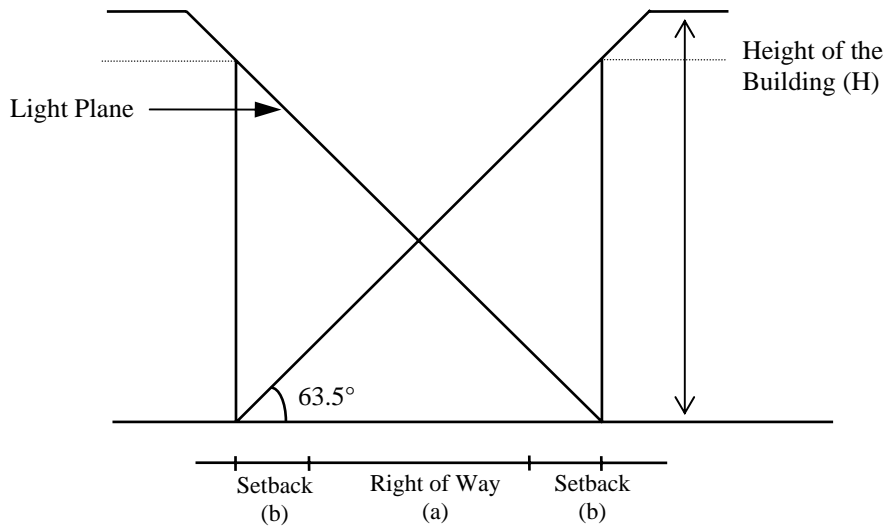

$$H = 2(a + 2b)$$

%= o; pklfjdf ejg agfpgsf] nflu hluvsf] Gogtd lfgkmm @ cggf @ k} f / af6f] E hf]8Psf] hluvsf] Gogtd klf6h !# lkm6 xg' kg5 .

- ^= o; pklfjdf lgDg pBfux? lgifv ul/Psf]5 M-
- sv/f tyf jw/ / rfkof kfg ug{
 - ; 8s 5paf luh tyf df6/; f0sn ddt j szk ; -rfng ug{
 - 7hf tyf demhf pBfu jftfj /of -kfgl, xj f / ; tx_ nf0{ kltsh c; / kfg] vfnsh] pBfux? ; -rfng ug{.

&= 3/ cuf]8sf]l; 9L ; 8ssf] /f06 ckm j] df kg]ul/ lgdf0f ug{ kf0g] 5g . o; pklfjdf jGg] ej gx?sf] Gogtd l; lnw xf06 & lkm6 ^ 0gr -@#) dl_ xg' kg5 .

*= of] dfkb08 nfu" xge6bf klxn] g} sfod ePsf dfx8f / hluvsf] lfgkmm o; dfkb08n] tfs}sf] Gogtd lfgkmm / dfx8f e6bf sd eP tfklg To:tf hluvsf] dfkb08n] tfs}sf] cGo kl/lw leq /xl lgdf0f ug{ kf0g5 .

-v_ afSnf]ldl>t a; f]f; pklfj M-

- o; pklfj c6tu6 Aofkl/s pklfjdf kg]lfg afx}sf bxfosf lfg kb5gM-
- k'tnl ; 8s, afuahf/, sdnfbl, l8Nnl ahf/, snlsf:yfg, d]lb]L, 1fgZj /, sdnkfy/L, ux]lw/f, 3\$}hf] xf8lufp5f]k/fgf]j :tl .
 - gfukfy/Lb]v gS; fn euj lt j xfn hfg]af6f}sf]pQ/ tkm{; 8ssf]5paf6 !% ld= ulx/f0{ Dd .
 - g/b]L, lj i0fdlt kh, 8Nn' x6}:j ode' e0v]hfg]af6f}sf]bf0f}j fofF; 8ssf]5paf6 b} }tkm{!% dl ulx/f0{ Dd, sk08fh, cgfdgu/, kNrf\$, hfj nfv]h, nugv]h, cflb .

!= o; pklfjdf ejgsf]clwstd uf]p08 se/h clwstd Pkm= P= cf/=, clwstd agfpg kfg] lfgkmm / clwstd prf0{lgDg adf]hd xg5 .

l; = g+	eagsf]lsl; d	h\ufsf] lfqkm	clwstd ufp08 se/h	^nf/ Pl/of /l; of] (FAR)	clwstd ej g agfpg kfpq] lfqkm	clwstd prf0{
!=	cfj f; lo	@ c f g f @ k} fb]v * c f g f; Dd	*) Ü	@=)	kn6sf] lf] x @=)	tnlrqdf byfP adf]hd nf06 knqnf0{ g5\$g] ul/ agfpg kfpq}.
@=	cfj f; lo	* c f g f eGb f a9L	^) Ü	@=)	h\ufsf] lf] x @=)	
#=	:sh SofDk;	-	\$) Ü	@=)	h\ufsf] lf] x @=)	
\$=	; /sf/L, cw{/sf/L sfofho, kf]nlSnlgs, gl; Exf] cflb	-	\$) Ü	@=)	h\ufsf] lf] x @=)	
%=	ko6g dGqfnoaf6 tf\$ \$f tf/]xf]h	-	\$) Ü	#=)	h\ufsf] lf] x #	
^=	l; gdf xn, lyP6/ ; efux	-	\$) Ü	@=)	h\ufsf] lf] x @	
&=	3/h; ; fgf pBf]y ; DaGwl Jofkf]s sDKn\$; / ; k/ dfs	-	%) Ü	@=)	h\ufsf] lf] x @	

Light Plane

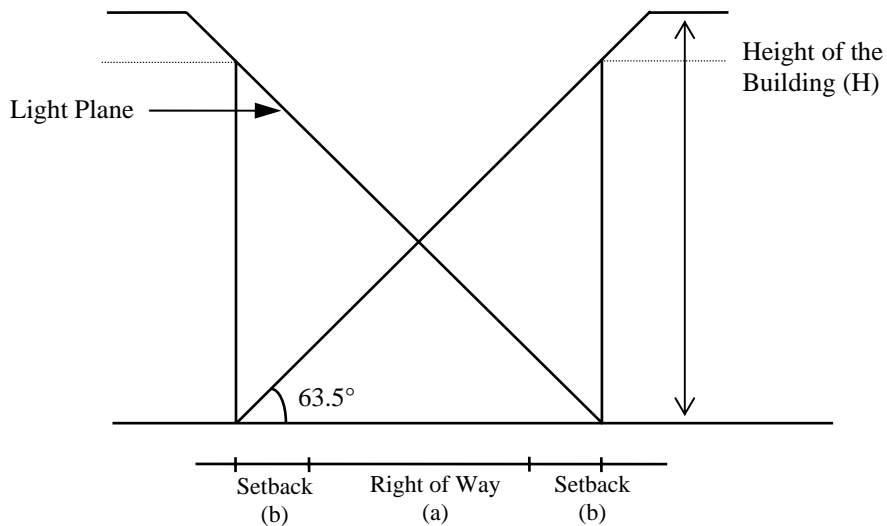

$$H = 2(a + 2b)$$

c08/ uflp08df kfls[agfpgsf] xsdf c08/ uflp08df kfls[sf] nflu agsf] hltstf] ^nf] Pl/of FAR df u0fgf ul/g]5 . o; pklf[df 3/ agfpgsf] nflu G[gttd hluufsf] lfkkm b0{c}f / af6] E hf]8Psf] hluufsf] G[gttd dfx8f \$ ld6/ -!# lkm6_ xg' kg5 .

@= o; pklf[df ; flj ssf] 3/ eTsf0{k} M lgdff ubf{ ; flj ssf] 3/ adf]hd lgdff ug{lb0g}5 . t/ ; 8s tkm[df] dx8fnf0{ ; 8ssf] lsgf/faf6 sDtl df Ps ld6/ ; fAofs 5f8l dfq lgdff ug{lb0g}5 . nf06 kn[- Light Plane_ nf0{g5\$g] ul/sg dfq 3/sf] prf0{l} gwff of ul/ lgdff ug{:j ls[t lb0g]5 .

#= o; pklf[df lgdg lsl; dsf] ej g lgdff u/df lgdg adf]hd kfls[sf] Joj :yf xgkg]5 .

- t/]xfn - hDdf hluufsf]@) kltzt
- l; gdf 3/ ; efu, lyP6/ cflb - hDdf hluufsf]@) kltzt
- Jofkl/s, sDkn\$; h:t}- ; k/ dfs - hDdf hluufsf]@) kltzt
- :sh SofDk; - hDdf hluufsf]!% kltzt
- kfl]nlnlgs, gl; fxf cflb - hDdf hluufsf]@) kltzt
- ; /sf/L, cw{/sf/L sfoffo - hDdf hluufsf]!% kltzt

\$= o; pklf[df lgdg pBfux? lgifv ul/Psf]5 M

- 7hf tyf demhf pBfu jftfj /of -xfj f, kgl, ; tx_ nf0{ kltsh c; / kfg] vfnsf] pBfux? :ykgf / ; -rfng ug{
- e0/xsf] ej gnf0{nh j f xfnhsf] ?kdf kofu ug{k/df cfj Zos kfls[sf] Joj :yf ul/ ; Dalwt lgsfosf] k' { ; j ls[t gn0{ ; -rfng ug{
- slbbp txsf] ; /sf/L tyf cw{/sf/L sfoffox?sf] ej g lgdff ug{.

-u_ c6o cfj fl; o pklf[M

o; pklf[df cfj f; lo lfk cgtuf kg] Jofkl/s pklf[, afSnf] ldl>t a; faf; pklf[/ ofhgfa4 cfj fl; o pklf[leq kg] pklf[afx\$sf lfk kb5g\

!= o; pklf[df ejgsf] clwstd uflp08 se/h, clwstd agfpg kfg] lfkkm, FAR / clwstd prf0{ lgdg cg; f/ xg5 M

l; = g+	ejgsf] lsl; d	hluufsf] lfkkm -lf]	clwstd uflp08 se/h -GCR_	^nf] Pl/of /l; of] FAR	clwstd ej g agfpg kfg] lfkkm	clwstd prf0{
!=	cfj f; lo	@ c}f @ k}f e6bf a9L * c}f; Dd	*) Ü	!-%	hluufsf] lfk x !-%	tnlrqdf b]yfP adf]hd nf06 kn[gnf0{ g5\$g] ul/ agfpg ; Sg5 .
@=	cfj f; lo	* c}f e6bf a9L	^*) Ü	!-%	hluufsf] lfk x !-%	
#=	:sh SofDk;	-	\$) Ü	!-%	hluufsf] lfk x !-%	
\$=	; /sf/L, cw{/sf/L sfoffo, kfl]nlnlgs, gl; fxf cflb	-	\$) Ü	!-%	hluufsf] lfk x !-%	

%=	ko6g d6qfnon] tf\$3f tf/]xf6h	-	\$) Ü	#=))	h\ufsf] lf3 x #=)
^=	l; gdf xn, lyP6/ ; efux	-	\$) Ü	@=))	h\ufsf] lf3 x @=)
&=	; fgf tyf 3/h' pBfu ; Da6wl ejg	-	\$) Ü	!=%	h\ufsf] lf3 x !=%
*=	; k/dfs6 h:tf Jofkl/s sDkn\$;	-	%) Ü	@=))	h\ufsf] lf3 x @=)

Light Plane

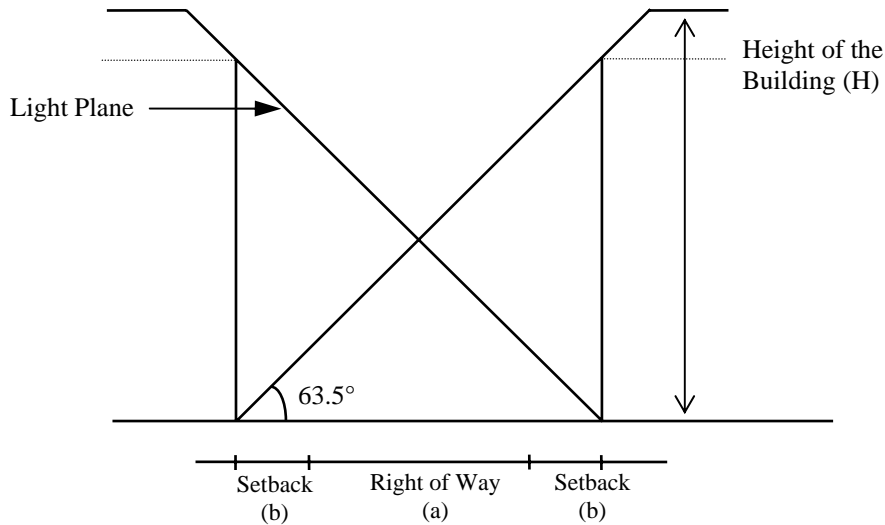

$$H = 2(a + 2b)$$

g6 M- c08/ ufP08df lj le6g ; le{ h / kfls(uf] Joj :yf ul/ agfpg] 3/sf] xsdf ; le{ h / kfls(uf] nflu agf0g] ^nf] Pl/of hit FAR df u0fg ul/g] 5g . To:t}j fb{nl -uf/f] aflx/ lgsnl agfPsf] j f 3/ leq 3; fP/ agfPsf] nf0{FAR df u0fg ul/g] 5g .

@= o; pklf6df lgDg lsl; dsf ejg lgdf6f u/3f lgDg adfllnd kfls(uf] Joj :yf xg' kg6 M-

- tf/]xf6h - h\ufsf] lf3kmsf]- @) kltzt
- l; gdf xn, ; efux, lyP6/ cflb h\ufsf] lf3kmsf] - @) kltzt
- Aofkl/s sDkn\$; h:tf- ; k/dfs6 cflb h\ufsf] lf3kmsf]- @) kltzt
- gl; Exf6, kflnlnlgs cflb - h\ufsf] lf3kmsf]@) kltzt
- ; /sf/L, cw{; /sf/L sf6f6o h\ufsf] lf3kmsf]@) kltzt
- :sh, SofDk; , h\ufsf] lf3kmsf]- !% kltzt

#= ln^6 /vL ejg lgdf6f u/sf]v08df / j] d66, ; [dj] d66 cfjf; lo k6f]hgsf] nflu ge}:6f]h tyf c6o ; le{ hsf]nflu agfPsf]v08df / 5fgf dfly a6g]ln^6sf]dl; g ?dsf] lf3kmsf] / ; 6L j] d66 j f j] d66sf]

lfqkmmnf0{ clwstd agfpg kfgpg} lfqkmmnsf] nflu u0fgf ul/g] 5g . To:t} j fbhl -3/sf] uf/f] aflx/
lgsfnlPsf]j f 3/ leq 3; fP/ agfPsf] nf0{FAR df u0fgf ul/g]5g .

- \$= o; pklfqdf lgdg pBfux? lgifw ul/Psf]5 M-
 - 7hf] tyf demhf pBfu :yfkf / ; ~rfng ug{
 - jf?b vfgf agfpg,
 - cs; lb] g kf08 lgdf0f ug{
 - 3Dtl ; s{ tyf ; s{ b\yfg,
 - slbbp jf lfqo :t/sf] ; /sf/l sfoffio / cw{ ; /sf/l sfoffio ej gx? lgdf0f ug{.

-3_ ofhgj 4 cfj f; lo pklfq M-

o; lsl; dsf] cfj f; lo lfqx? ; /sf/l j f u} ; /sf/l :t/jf6 lj sl; t ul/bf sf7df8f;pkTosf gu/ lj sf;
; ldl tjf6 lgdg adf]hdsf cfwf/et ; lj wfx? - af6f] 9n, vfgkfgl, lj hhlsl] :t/ _ ; d] vh3f] ofhgf agf0{
:jlsf u/fpg'kg5 .

!=	<u>af6f]rf8f0{</u>	<u>cg' /of ug{kg]dfkb08</u>
	s_ dh ; 8s hf8g]af6f]rf8f0{	& -; ft_ ld6/ Go9td
	v_ Jns Ansdf hfgaf6f]	% -kf#_ ld6/ Go9td
	u_ kn6 kn6df hfgaf6f]	\$ -rf/_ ld6/ Go9td
	3_ sn 8 :ofs -Cul De SAC_ af6f]	^) -; f#_ ld6/ e6bf a9L xg'gxg]

@=	<u>kn6 ; f0h</u>	
	s_ 38]lsf]rf8f0{	^ -5_ ld6/ Go9td
	v_ 38]lsf]lfqkm	@ -b0{ cfgf @ k} f Go9td

#=	<u>kn6sf]-Depth_ 8fy</u>	
	s_+ @ cfgf @ k} f - \$ cfgf ; Ddf	!=% x rf8f0{
	v_ \$ cfgf e6bf a9L - * cfgf ; Ddf	!&% x rf8f0{
	u_ * cfgf e6bf a9L - !@ cfgf ; Ddf	@ x rf8f0{

\$=	<u>vhf ; fj hlgf lfq - af6f]afx\$ _</u>	
	s_ % /fkgl - !) /fkgl ; Ddf	hDdf hluvsf]% -kf#_ kl'tzt
	v_ !) /fkgl e6bf a9L @% /fkgl; Dd	hDdf hluvsf]\$ -rf/_ kl'tzt
	u_ @% /fkgl e6bf a9L !)) /fkgl; Dd	hDdf hluvsf]#=% -; f9]tlg_ kl'tzt
	3_ !)) /fkgl e6bf a9L	hDdf hluvsf]@=% -c9f0{ kl'tzt

%= lj lj w M-

s_ vfgkfgl, 9n lgsf; , lj B't, 6]nkrfq cflb lj :tf/ ug{/ cfunfulsf] ; dodf af?0fo6q ; d] nhfg
; /n tyf ; ud xg]u/L :yglo 6fkf]kldf plrt Wofg lb0{af6f]f]/vfgs ug{kg5 .

v_ ofhgfa4 cfj fl; o pk-Ifqdf vNnf efu (**Set Back**) !=% dl= 5f8L dfq lgdf0f ug{kf0g5 / FAR
sf] xsdf cfj fl; o ejgsf] nflu @ / Jofkfl/s ejgsf] nflu clwstd **FAR #=)** lb0g5 . 3/n]
cfu6g kfgp]efu (**Ground Coverage**) c6o cfj fl; o pk-Ifqsf]cg; f/ xg5 .

-u_ bxfosf ofhgfa4 cfj fl; o lfgdf bxf o adfjhd xg5 M-

c_ uNkmbf/ cfj f; cfofhgfsf]lgdf0f ; Da6wL dfkb08 M-

!_ 3/n]cfj]6g ; Sg]hluf (Ground Coverage) ; flj sdf *) kltzt eP tflg ^) kltzt sfod ug[.

@_ \$ cfgfsf]hlufdf rf/ tNnf / e-of^a v08 dfqsf]kfFf}tNnfsf]nflu clwstd prf0{\$!U sfod ug[.

#_ ; 6 Jofssf]xsdf ; 8ssf]lsgf/faf6 sltdf @ dl6/ 5f8g kg[hlufsf]rf8f0{tkm{bf6f af6f 5f8g gkg[. pNn]vt ; 6 Jofs lgoddf Irregular Plot sf]xsdf cfj Zostfg; f/ sfof]j og ; ldltn]56 lbg ; Sg].

\$_ 3/ agfpg sf-p-g-lj -of}sfof]j og ; ldltn]gS; f l; krf/; ug[/ uf-lj =; -n]lj lwj t'gS; f kf; ug[.

%_ 3/ agfp6f Ps kn6df Pp6f 3/ agfpg kg[@ kn6 ldnfP/ Pp6f 3/ agfpg lgifv ug[.

cf_ shZj/ cfj f; cfofhgf lfgsf]dfkb08 M-

!_ ; 8ssf]l; dfgfb]v @ dl6/ 5f8L dfq 3/ tyf 6x/f lgdf0f ug{lbg]. - kvf{nsf]xsdf ; 8ssf] l; dfgdf g}^ kn6 prf0df ga9f0{agfpg lbg].

@_ k5f18 tkm{cf^g}hluf sltdf ! dl6/ 5f8L dfq 3/ agfpg lbg].

#_ hdlgsf]bf6f af6f tkm{em6fn, sf}L /fVg k/df cf^g}hdlg sltdf @ dl6/ 5f8L dfq 3/ agfpg lbg].

\$_ afb]l, sf}L, 5t, kvf 0Tofbl afx/ lg:sg]efux? pNn]vt Gogtd 5f8g kg[hdlgdf lgsfNg lb0g]5g .

%_ ; 8ssf] ; txaf6 38]l[sf] ; tx w}]dfly kf/L df6/ leq; Dd nfg ; Dej gePsf]v08df Uof/h ; 8ssf]l; dfgf b]v g}agfpg ; lsg5 .

^_ 5fgfsf]kfgl af6f/ l5d\$lsf]hdlgdf v:g]u/l 5fgf 5fpg lb0g]5g .

&_ 3/sf]tNnf clwstd \$ tNnf / clwstd prf0{\$) kn6 dfq lb0g5 / pNn]vt prf0{cfj f; - lkn6y_ ; tx b]v 5fgfsf] ; tx; Dd gflkg5 .

*_ ; flj s 3/sf]yk / ; wf/ sfo{ubf{bkrf -!_ nfu"xg]5g t/ c6o ; a}bkrf]kfngf xg' kg5 .

0_ shZj/ cfj f; cfofhgf, ahf/ lfgsf]dfkb08 M-

!_ kn6 g+! sf]nflu dh ; 8s k\$L @ dl, cuf18 ! dl, bf6f k\$L ! dl 5f8] dfq / agfpg kf0g5 . @ j 6f k; n sj n /fVg' kg[tyf 3/ leq k:g 9f}sf dh ; 8s k\$L xg' kg[.

@_ kn6 g+@ sf]nflu cuf18 ! dl6/ (Slide Lane) k\$L @ dl= af6f k\$L ! dl= 5f8g'kg5 . cuf18 @ j 6f k; n sj n /fVg' kg[/ 3/ leq k:g 9f}sf (Slide Lane) k\$L xg' kg5 .

#_ kn6 g+#, (, !), !\$, !% sf]/ !(sf]nflu cuf18 ! dl= / k5f18 @ dl= 5f8g' kg5 . bf6f cyj f af6fk\$ #) ; dl= 5f8g' kg5 . cuf18 @ j 6f k; n sj n / k5f18k\$ 3/ leq k:g; f08 tkm{ k; n sj n vfl]g ; lsg]t/ l; 8L agfpg kf0g]5g .

\$_ kn6 g+ \$, %, ^, &, *, !!, !@, !#, !^, !& / !* sf]nflu cufl8 ! dl= k5f8l @ dl= 5f8g' kg[/
 bf6f af6f 5f8g' gkg[. cufl8 @ k; n sj n / k5f8af6 3/ leq k:g].
 %_ kn6 g+@) sf]nflu cufl8 ! dl= k5f8l @ dl / bf6f af6f6f ! dl= 5f8g' kg5 . cufl8 @ j 6f
 k; n sj n / k5f8l 3/af6 leq k:g].
 ^_ kn6 g+@! / @@ sf]nflu cufl8 ! dl=, k5f8l @ dl= bf6f af6f 5f8g' gkg[tyf cufl8af6 3/
 leq k:g].
 &_ kn6 g+! b]v @@ ; Dd tnsf]xsdf e-of^a ; d] u/] hDdf # tnf; Dd dfq ug{; lsg5 . tlq
 tNnf]v dfq cufl8 k\$! a9ldf ^) ; 3dl= ; Dd dfq Sof6ln6/ -:Nofj_ lgsfNg ; lsg5 .
 3fdkfgl 5\$gsf]nflu ; f]Sof6ln6/df sf7f agfpg kf0g]5g .

Open Space sf]Level af6 a9ldf #) ; 3dl= ; Dd dfq D.P.C. sf]n6n ug{; lsg5 .
 Sof6ln6/sf]xsdf klxnf]tNnfdf cufl8 a9ldf #* ; 3dl= ; Dd dfq lgsfNg kf0g5 .

; fy}ol ; a}lgodx?nf0{cfwf/ dfgl Pp6f gd6fsf]?kdf gS; fx? tof/ kfl/Psf 5g\ ; j]
 gS; f cg; f/ g}xg' kg5 .

*_ ol dfyl pnn]vt ; a}kn6x?sf]cufl8sf]df]8f Open Space tkm{/flvPsf]5 .
 (_ pOm lf6df lgdf6f xg]3/ ; sj Dd gkfnl z]ldf ldNbf]hNbf]xg' kg5 .

g6 M - cfj f; cfo]hgfsf]lg0f6 adf]hd sfod ul/Psf]. _

#= ; :yfut lf6 M ; /sf/L, cw{; /sf/L tyf c6o ; fj h]gs sfo6f lgldQ k6f]df cfPsf tyf cfp]g]gS; fdf
 b]yf0Psf lf6 o; lf6 c6tu6 kb5g\ o; lf6nf0{lgD6f pklf6x?df lj efhg ul/Psf]5 M

- s_ ; /sf/L tyf cw{; /sf/L sfoffno pklf6 (Government & Semi Government Sub-Zone)
- v_ :j f:Yo ; j]f pklf6 (Health Services Sub-Zone)
- u_ z]l]fs pklf6 / (Educational Sub-Zone)
- 3_ kx/L tyf ; lgs pklf6 (Police & Army Sub-Zone)

-s_ ; /sf/L tyf cw{; /sf/L sfoffno pklf6 M

; /sf/L tyf cw{; /sf/L pklf6df ej gsf clwstd uf]p08 se/h, FAR tyf kfls6 :ynsf]Joj :yf lgDg
 adf]hd xg5 M

- clwstd uf]p08 se/h - %) k]tzt
- FAR - @=%)
- G6gtd kfls6 :yn - hDdf h]ufsf]@) k]tzt

-v_ :j f:Yo ; j]f pklf6 M

o; pklf6df ej gsf]clwstd uf]p08 se/h, FAR tyf kfls6 :ynsf]Joj :yf lgDg adf]hd xg5 M

- clwstd uf]p08 se/h - \$) k]tzt
- FAR - @=%)
- G6gtd kfls6 :yn - hDdf h]ufsf]@% k]tzt

-u_ z]lfs pklf] M-

- o; pklf]df ejgsf]clwstd uf]p08 se/h, FAR tyf kfls€ :ynsf]JoJ :yfdf lgDgf adf]hd xg] M
 - clwstd uf]p08 se/h - \$) kltzt
 - FAR - @-%)
 - Gøgttd kfls€ :yn - hDdf hlufsf]!% kltzt

-3_ kx/l tyf ; lgs pklf] M-

o; pklf]df lgdf] ubf{ ; DalGwt ; :yfn] ; DalGwt sfof] og ; ldt ; u ; d]jo /fvl lgdf] sfo{ug{ kg].

-a_ cGo JoJ :yf

- ; /sf/l tyf cw{ ; /sf/l sfof]ox?, z]lfs ; :yfx? - :sh, snh, ljZj ljBfno_ :jf:Yo ; jf; u ; DalGwt :jf:Yo s]b] c:ktn, gl; € x]d, k]n]n]n]lgs / ; /sf/l tyf lghl a\$? cfl lgdf] ug]nflu ejgsf]j l/kl/ To]td # ld6/ vNnf /Vg'kg].
- :jf:Yo ; jf; u ; DalGwt :jf:Yo s]b] c:ktn, gl; € x]d, k]n]n]n]lgs cflbdf pkrf/sf] qmddf lgl:sg]k]f]x] d]hfx? cf^g}SDkfp08 leq cfm]JoJ :yfk] ug]JoJ :yf ug{kg].
- Ps k6sdf !) hgf eGbf a9L dflg; Ps}k6s hDdf gxg]vfnsf ; :yfut ejgx?nf0{e" pkof] l]df kg]dfkb08 cg' / g}ejg lgdf] ug{lb] ; lsg].
- ejg lgdf] ubf{sg k]f]hgsf]nflu lgdf] xg]x] ; f]l k]f]hgsf]dfkb08sf]cfwf/df :jLs[t lb] ; Sg].
- sg}klg pklf]df Jofkl/s k]f]hgsf]nflu lgdf] :jLs[t ubf{pQm lgdf] xg]ejgsf]nflu slDtdf @ /f]k]l hluf xg' kg].
- ; :yfut k]f]hgsf]lgldQ lgdf] xg]ejgsf]sh l]qkm % -kfF_ xhf/ :Sj fo/ lkm6 eGbf a9L ePdf ; f]ejgsf]:jLs[t lb] ; :yfut l]qsf]dfkb08 nfu"kg].

\$= c]B]lus l] M- c]B]lus l] c]tu] x]n sfod afnfh' k]6g tyf eQm/ c]B]lus l]x? kb]g\ sf7df8f]pk]osdf l]leG k]lj lws sf/Ofx?n]ubf{ ; jf ; DjGwl pB]u afx] cGo pB]ux?nf0{lg?I; flxt ug]. kfgl / x]f] blift xg]vfgsf]pB]ux? ; j {fwf/Of hgtfsf]cf]f; b]v %)) ld6/ leq /Vg glbg].

%= ; AfOf l] M- ; AfOf l] c]tu] P]txf] ; s, wld\$, k/ftfl]s tyf jftfj/Of ; AfOfsf]lgldQ cfjZos vNnf xl/ofnl l] gblsf]bfof]f]of]f] 3f6x? kb]g\ o; l]df ; Da4g / ; AfOf ug]sfo{afx] cGo sfo{ ug{kf0g]5g]. o; l] c]tu] lgDg pklf]x?nf0{t]sPsf 5gM-

- S_ xl/ofnl vNnf pklf] (Green Open Sub-Zone)
- V_ kfs{ag pklf] (Forest & Park Sub-Zone)
- u_ ; f:s[t]s, k/ftfl]s tyf wld\$ pklf] (Cultural, Archeological & Religious Sub-Zone)

-s_ xl/ofnl vlnf pklf -6l8vj_ M

o; cgtuf lgdg pklf kb5g\

!= bz/y /uzfnf

@= 6l8vj

#= ; lgs d-r

\$= /Tgkfs{

%= /fglkf\l

^= e56l d08k

-v_ kfs{ag pklf M

o; pklf cgtuf /fgljg, xfljg, :j ode, j f j f/l, lrl8ofvfgf cflb :yfgx? kb5g\

-u_ ; f:s[ts, k/ftflj s tyf wld\$ pklf M

gkfn ; /sf/n]/fhkqdf ; r'gf k\$flzt ul/ ; #lft :df/s lfg 3flift u/\$f lfg, k/fgf zx/ lfgsf]; #lfof lfg afx\$sf c6o ; f:s[ts, Pltxfl; s, k/fgf k/ftflj s tyf wld\$ lfgx?nf0{hgfp55. o; cgtuf lgdg lfg kb5g\ hg lsQf gkl g\$; df b\fp0psf]5 .

tkl; n

sf-g=kf=j 8f g+

; f:s[ts, Pltxfl; s, wld\$ lfgsf]gfd

!= j 8f

g\$; fn, euj tl, g6bs; f\ dxfb], z\$ /sIt{dxflj lj xf/, xl/x/ gf/fo0f, uf0f u0fz, ltgwf/f, gf/flx6l, gfukf\l, hdnj xfn, rf/ 9#] - nldlgf/fo0f, g6b sZj /j xfn, sdn kf\l, g6bsz/ -9#v/f_

@= j 8f

lgn ; /:j tl

#= j 8f

-

\$= j 8f

ef6e6gl, ; Togf/fo0f dlGb/, wdj f/fxl dlGb/

%= j 8f

6gfnb]l, s[0fdlGb/, k#d\l j }0ffj l, uxgfkf\l

^= j 8f

af#

&= j 8f

euj fg :yfg, r6b|lj gfos, rf?dtl j xfn

*= j 8f

kzklt

(= j 8f

/fdrGb|dlGb/

!!= j 8f

lqk/f ; 6b/l, sfndf]g 3f6, sfndf]g 3f6 x6} 6\$bf0fg / /fdrGb|d7 / dlGb/, eb\$fnl, gfgs dlGb/

!@ j 8f

gf/fo0f dlGb/, ClifZj / dlGb/, eXj dlGb/

!# j 8f

leddQmZj / dxfb], 6sZj / dxfb], lgnj f/fxl

!\$	j 8f	snsl :yfg, shZj / dxfb]
!%	j 8f	:j oDe," lj hZj /L, zfðfeuj tl
!^	j 8f	afnfh,' DxkL dIGb/, uOfz dIGb/
!&	j 8f	OGbf00fl dIGb/
#!	j 8f	sdnfbL uOfz:yfg, dxfsfn
#@	j 8f	sflnsf:yfg
##	j 8f	eXj dIGb/, dXlbjL
#\$	j 8f	sfðZj / dxfb]

kf6g tkm(n-k=g=kf=	czf\$:tkx? -k/fgf]zx/ aflx/sf_	
#	j 8f	clfZj / dxflj xf/
(/ @	j 8f	zvdh 3f6
@	j 8f	/fhltY{3f6
%	j 8f	dxfnldL dGbl/, nugvñ
^	j 8f	j 6s eXj
*	j 8f	j fn sdf/L :yfg
(j 8f	efñf uOfz

pNn]vt lq?df lGdg dfkb08 nfu"Xg5 M-

!= :df/ssf lq tyf :df/sn]rrf] lq tyf sDkfp08; E hf]8Psf lsQfx?df \$% lkm6 -!#=&) ld6/_ sf] prf0{; Ddfsf]3/ lgdf0f ug{; lsg5 .

@= o; lqsf :df/sx? k\$lsf]dfx8fx? k/Dk/fut gkfnL zñldf lgdf0f ug{kg5 .

#= ; Af0f lq leqsf tf]sPsf :df/ssf j/lkl/ ; GwL ; kG kg]lsQfx?df 3/, ejg, lgdf0f ubf{:df/d k\$S sDtldf !) lkm6 5f8] dfq lgdf0f ug{kf0g5 .

^= **zx/ lj :tf/ lq M-** sf7df8f]pkiosf leqsf gu/ pGdV \$% j 6f uf=j=; = x?nf0{o; lq cGtu{ /flvPsf] 5 .

^=! o; lq ejg lgdf0f kpfñhsf]nflu hluvsf]Gogtd lqkmm b0{cfgf b0{k}f xg'kg5 / af6f] E hf]8Psf] hluvsf]Gogtd dfx8f ^ ld6/ xg'kg5 .

^=@ o; lq leq ejg lgdf0f]sf]nflu lgdg cg; f/ :jls{ lbg ; lsg5 M-

l; = g+	ej gsf]lsl; d	hllufsf] lfqkmn -lf]	clwstd uflp08 se/h -GCR	^nf/ Pl/of /l; of] (FAR)	clwstd ej g agfpg kfpg] lfqkmn	clwstd prf0{
!=	cfj f; lo	@ c f g f @ k } f b] v ! / f k g l ; D d	&) Ü	!=@%	lfj x !=@%	tnlrqdf byfP h: t } n f 0 6 knqnf0{g5\$g] ul/ agfpg kf0g\$.
@=	cfj f; lo	! / f k g l e g b f a 9 l	%) Ü	!=@%	lfj x !=@%	
#=	:sh Sofdk;	-	\$) Ü	!=%)	lfj x !=%	
\$=	tf/]xfqjh	-	\$) Ü	#=))	lfj x #=)	
%=	l; gdf xn, lyP6/ ; efux	-	\$) Ü	@=))	lfj x @=)	
^=	gl; Exfd, kfl]nlsNgl's cflb / 3/h' j f ; fgf pBfl; ; Da6wl sfd	-	\$)	!=%)	lfj x !=%	

Light Plane

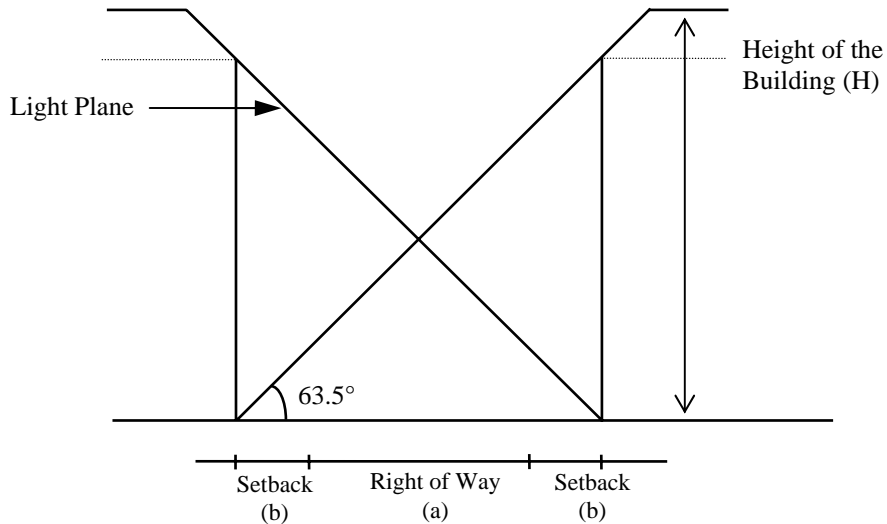

$$H = 2(a + 2b)$$

^# bfofJ fofF/ k5f8L k6L lj leGg lsl; dsf]3/sf]nflu lgDg cg' f/ vfnl hluf 5f8g' kg5 .

^#=# c; jGw -Detached_ 3/ agfpgsf]nflu bfofJ fofF/ k5f8L k6L Gogtd !=% ld= -% lkm6_ vhf efu 5f8g' kg5 / af6f]k6L af6f\$]rf8f0{k15 Gogtd ! ld6/ 5f8g' kg5 .

^#=@ ; DaGw -Semidetached_ 3/ agfpgsf]nflu k5f8L / Ps ; f08tkm{sDtldf !=% ld= -% lkm6_ 5f8g' kg5 .

^#=# af6f] E hf]8Psf]kn6df af6f]lt/ -cuf]8 kl6_ sDtldf af6f\$]rf8f0{-R.O.W_ k15 Ps ld6/ 5f8L klQmj 4 -ROW_ bfofJ fofF; 6fP/ 3/ agfpg]h]bfofJ fofFvvhf efu 5f8g' gkg] k5f8L k6L Gogtd !=% ld= -% lkm6_ vhf efu 5f8g' kg5 .

^=\$ cfj f; lo kpf]hgsf]nflu ge}:6f]h / cG ; le{ hsf]nflu kpf]u ug[xf]eg]j d[6n]cf]u6\$]f] lfgkm clwstd agfpg kfg lfgkm -FAR_ df uofgf ul/g]5g . To:t}5fgf dflysf]ln^6 d]zg 3/ / kfg 6slsf]lfgkm klg FAR sf]nflu uofgf ul/g]5g .

^=% o; lfgdf lgDg lsl; dsf ej g lgdf u/df lgDg adf]hdsf]kfls{sf]Joj :yf xg' kg5 .

- s_ tf/]xf]h - hDdf hUffsf]@) k|tzt
- v_ l; gdf xn - hDdf hUffsf]@) k|tzt
- u_ gl; E xfd kfl]hlnlgs cflb - hDdf hUffsf]@) k|tzt
- 3_ :sh Sofdk; - hDdf hUffsf]!% k|tzt

&= ; tx ; jf/L lfg M- o; lfg cftuf j; kfs{ 6s kfs{ sf/ kfs{ tyf ; 8s cflb kb5g\ . o; lfgdf sg} lgdf sfo{ubf{; DalGwt lgsfo; # :jLs[t lng' kg5 .

*= lj dfg :yn lfg M- of] lfgdf lqej g cft/f]60 lj dfg :yn lfg / ; f]af6 kdf]oft lfgnf0{hgfp55 . o; lfgdf lj dfg :ynsf]lj sf; ; DaGwl sfo{ug{kf0g5 .

(= v]hsb lfg M- o; lfgdf v]hsb ljsf; sf nflu tof/ ul/Psf]bz/y /#zfnf ; fgf]uf]/ cflb kb5g\ . v]hsb ; DaGwl lgdf sfo\$]:jLs[t ; DalGwt lgsfoaf6 lng' kg5 .

!) gf/fo0fix6L b/j f/ Pl/ofsf]dfkb08 M-

!)= gf/fo0fix6L b/j f/ sDkfp08b]v #)) lkm6 ; Ddsf]b/lleq ul/g]lgdf ; DaGwl dfkb08 b]fo adf]hd xg5 / ; f]afx\$]sf]lfgsf]xsdf hg pklfg leq kb5 ; f]pklfgsf]dfkb08 nfu" xg5 .

!= e0{x\$]f]ejg e]tsf0{gofFejg agpbf e0{x\$]f]ejg dd t u/L tNnf yk ubf{jf vfnl /x\$]f] hlufdf gofFejg lgdf ubf{clwstd tNnf # tyf clwstd prf0{#} lkm6; Dd /fVg ; lsg5 .

@= o; lfgsf]FAR @=\$ sfod ul/Psf]5 .

#= gf/fo0fix6L b/af/sf]sDkfp08sf]j l/kl/sf]; 8sdf cf'gf]hlufsf]5]paf6 @ ld6/ ; Jofs 5f8L lgdf ug{k}kg5 .

\$= gofFejg lgdf ubf{clwstd uf]p08 se/h *) k|tzt sfod ul/Psf]5 .

%= gf/fo0fix6L b/j f/ sDkfp08 b]v ^)) lkm6; Ddsf]bl/leqsf]snsf/vfgf, js{k - ulln lgdf df/ tyf df/; f0sn dd t cflb sfo\$]nflu _ vNnf df5f df; 'k; n tyf kzj wzfnf, k]h kDk tyf lofF, d\$]Lth h:tf kl]j ngzln kbfx?sf]e08f/ tyf Wj gl / j fo' kpf]of xg]vfnsf] kpf]u lgif]v ul/Psf]5 .

!!= v]hf lsgf/df lgdf ug]; DaGwdf M-

j fldtL, lj i0fdtL / dgf]/fsf]bfofJ fofFv]hf 5]paf6 @) ld6/ 5f8L dfq lgdf{ug{kf0g5 . wf]lvf]hsf]xsdf wf]j v]hf cfof]hg ePsf]:yfgdf Project sf]Planning cg' f/ xg5 .

tn pNn]vt vfjhsf]xsdf ; f]; DaGwl cWooG kl]tj bG kfk't e0{ sk]5 tfl]sgf .

- aNv' vfjh
- gVv' vfjh
- 6S'rf vfjh
- ; fdfvl;
- sfB's' vfjh
- dxfb] vfjh
- sdGfzf vfjh
- s/v'; l

!@= ; eQm cfj f; (**Apartment**) ej g ; DaGwdf M-
xfn cj]yt rqnky aflx/ ; eQm cfj f; ej g lgdfQf ubf{lgDgfg; f/ xg} M-

!= FAR - #=%
@= cuf]8 k]L ; f]ofs - GoGtd * dl6/
#= bfBf afBf / k5f]8 k]L ; f]ofs - GoGtd ^ dl6/
\$= ; eQm cfj f; :yn; # hf]B]g] k] zdfu{ tyf ; f] k] zdfu{ # hf]B]g] ; 8ssf] GoGtd rfBf0{ * dl6/
lkm]8df g}xg' kg} .
%= cGo kfj wfgsf] xsdf ; eQm cfj f; ej g (**Apartment Housing**) lgdfQf ; DaGwl dfkb08, @)^@
cg; f/ g}xg} .

rqnky leq ; eQm cfj f; ej g lgdfQf ubf{ ; eQm cfj f; ej g (**Apartment Housing**) lgdfQf
; DaGwl dfkb08, @)^@ cg; f/ g}xg} .

!#= lj lj w M-

- gu/ of]hgf nfu" ePsf] lfgdf lgdfQf -; wf/ j f gof]lgdfQf_ ug}sf] nflu ; DalGwt gu/kflnsf j f
sfof]j og ; ldltsf]lnlvt :J]ls} Ing clgj fo{xg} .
- sg}JolQm j f ; :yfn]k]tflj t lj sf; sfof]j nflu cfj Zos k/]df ; DalGwt sfof]j og ; ldltaf6 s]
s:tf]lgoGqof, lgb}zg Otofbl xg ; Sg} eG]j f/]hfgsf/L Ing ; lsg} .
- xfn ePsf]3/, af6f,]9n Otofbl b]f0Psf]; f06 knfg ; lxt gS; fdf k]tflj t 3/ /xg]hluf / dh
af6f] E s:tf]; DaGwf /xg]5 ; f]; d] b]fpg' kg} . pbfx/0fsf]lgldQ af6f]sf]nf0g, rfBf0{bfofF
j fofF?v /f]g]xf]eg]o:tf ?vx? ; fy}9n gfnl Otofbl eP ; f]; d] b]fpg' kg} .
- k]tflj t 3/sf]; f06 knfg, knffg, Olne] g tyf ; \$; g cflb vhf0Psf]gS; f b/vf:t kq; fy k}z
ug{kg} .
- gS; f k}z ubf{; f06 kn6df **Septic Tank** clgj fo{?kdf b]fpg' kg} . ; f]k]tflj t **Septic Tank**
D.P.C. r} ug]; do ; Dddf lgdfQf e} s}sf]xg' kg} .
- lgdfQf :yndf :j]ls} ; f06 knfg ; lxtsf]gS; f clgj fo{?kn]/xg' kg]5 .
- :sjh M

- d f x 8 f k n f g / ; \$; g ! M)) j f ! M %) d f .
- ; f 0 6 k n f g ! - / f k g l ; D D f ! M)) / ! b l v # / f k g l ; D D f ! M)) o ; e G b f a 9 L ! M \$)) d f .

- b / v f : t k q \$ k l t / g S ; f ; % k l t : j L s [t s f] n f l u k z u g { k g } .
- c f ^ g f] 3 / h l u f s f] l g : ; f s f] @ - @ y f g k d f l o f t h l u f w g l k d f o f k h f { d f n k f t , l t / \$ f] / l ; b / g f k l g S ; f s f] k l t i n k l x ? ; f y d f x g ' k g } .
- e j g s f] l g d f o f ; D k G G f e P k l 5 3 / w l g n] ; D a l G w t g u / k f l n s f a f 6 s f o { ; D k G G f e P s f] h f # u / f 0 { : j L s [t l n g ' k g } .
- l g d f o f c j l w d f ; 8 s d f l x 8 g u f x f] x g] u l / l g d f o f ; f d f u l ; 8 s s f] 5 p d f / f v g k f 0 g] 5 g .
- n x / } 3 / x ? e P d f l j r d f 3 / a g f p b f b f o f F j f o f F 3 / s f] ; / l f s f] J o j : y f u g { k g } .
- s g } k l g l s l ; d s f] e - p k o f u u b f { j f k l / j t g u b f { ; D a l G w t l h n n f s f g u / l j s f ; ; l d l t s f] s f o f j o g ; l d l t a f 6 k j { : j L s [t l n g ' k g } .
- o ; d f k b 0 8 s f k l j w f g x ? c g ; f / s g } l s Q d f ; f] l s Q f s f] l f g k m n c g ; f / t f] s P s f] c l w s t d u f p 0 8 s e / h / F A R e G b f a 9 L e j g n f 0 { l j : t f / u g { l b 0 g] 5 g } .
- s f 7 d f 8 f] p k t o s f g u / l j s f ; o f h g f l f g l e q 3 / a g f p b f ; D a l G w t g u / k f l n s f d f j f u f - j = ; = x ? d f b t f { e P s f l 8 h f 0 g / x ? a f 6 d f q 3 / s f] g S ; f u / f 0 { g S ; f b t f { u / f p g ' k g } .
- b t f { x g r f x g] l 8 h f 0 g / s f] G o g t d z l f s o f j o t f d f G o t f k k t ; y f a f 6 c f l s 6 \$ 6 j f l ; l e n 0 G h l l g o l / u l j i f o d f l 8 u l j f l 8 k n f o f k k t e P s f] x g ' k g } .
- # - l t g _ t n f j f !))) j u { l k m 6 ; D d l k n G y P l / o f e P s f] 3 / s f] g S ; f k f ; u b f { ; f l j s c g ; f / k n f g , 0 n e } g , ; \$; g , ; f 0 6 k n f g , n f \$] g k n f g c f l b g u / k f l n s f d f b t f { e P s f] l 8 h f 0 g / x ? a f 6 u / \$ f] e P k l g x g] t / # t n f e G b f c l n f] j f !))) j = k m e G b f a 9 L l k n G y P l / o f e P s f] 3 / x ? s f] l 8 h f 0 g g u / k f l n s f a f 6 0 h f h t k k t c f l s 6 \$ 6 j f 0 G h l l g o / a f 6 t o f / u l / P s f] x g ' k g [/ A r c h i t e c t u r a l D r a w i n g S f] ; f y } S t r u c t u r a l / S a n i t a r y d r a w i n g k l g ; d f j] u l / k z u g { k g } . ^ t n f e G b f c l n f] a l g g] e j g x ? s f] n f l u c l g j f o { ? k d f l n ^ 6 (L i f t) , k n f P / 0 : s k (F i r e E s c a p e) / k n f P / ;] 6 L (F i r e S a f e t y) s f] J o j : y f u / \$ } x g ' k g } / c f l s 6 \$ r / n l 8 h f 0 g s f] g S ; f x ? s f] ; f y ; f y } : 6 \$ r / n / : o f g } / l l 8 h f 0 g s f] g S ; f x ? ; d t ; f y d f k z u g { k g } .
- ; f j h l g s , j f 6 f] 3 f 6 f] k l , r f \$ c f l b / ; f j h l g s r f } x ? d f s g } k l g ; f d f g x ? v f ; u l / l g d f o f ; f d u l x ? ; # 0 / a t l j v g s f] n f l u y k f g { ; d t k f 0 g] 5 g . ; j { f w f / o f s f] c f j f u d g n f 0 { j f w f x g] u l / l 5 d \$ l x ? n f 0 { ; d t k l t s h c ; / k g] u l / s g } k l g ; f d f g ; f j h l g s : y n d f / f v g l b 0 g] 5 g . T o : t f] / f v g k f 0 g] 7 f p b f ; f d f g y k f / \$ f] v 0 8 d f ; D a l G w t g u / k f l n s f n] b 0 8 u g { ; S G f } .

- pk/fQm cg; f/ ejg ; DkGgsf] l; km/; kq lb0Psfdf ejg :jLst gS; f cg; f/ gePdf lgh l8hf0gstf\$]bt{vf/h ul/ lgh dfly Pq sfgd adfllnd sfoj fxl ul/g\$.
- lgdfdf sfo{; DkGgf xg g; sdf lgdfdf sfo{ug{tf]sPsf]cj lwdf ejgsf]hlt efu ; DkGg ePsf]5 ; f]sf]; DkGgtfsf]kdf0f kq lng' kg\$.
- ejg lgdfdf e} s\$]l]sQfdf lsQfs6 ug{k/df ; DalGwt dfnkf] sfofno / gkl zfvfn]; DalGwt :yfglo lgsfo jf sf-p-g-lj-of]sf=-af6 l; kmf/; ln0{dfq lsQf sf6 ul/ lbg' kg\$. To:tf] l; kmf/; lbdf dfkb08n]pknAw u/fPsf]u]p08 se/h / FAR nf0{wofgdf /vlg' kg\$.

9n tyf kfglsf]lgsf; Joj :yf M

- sfod /x\$]9n jf kfglsf]lgsf; nf0{sg}klg lsl; dsf]lgdfdf sfo{ubf{agb ug{kf0g]5g} .

; fun jf gfn M

- dflyaf6 kmf/ dhf v; flbf hldg ; Dd g}kf0kaf/f kmf/ dhf v; flng' kg\$.

%ofn jf e]6lnb/ ; wof/sf]hluf; E hf\$ agfpbf M

- cf^gf]hlufsf ; fw l; dfgdf 3/ agfpbf ; wof/sf]:jLst afx\$ cGo cj :yfdf %ofn jf e]6lnb/ jf sg}lsl; dsf]lgsf; sf]Joj :yf ug{kf0g]5g} .

l; dfgf 3g]Joj :yf M

- ; fj hlgf rf} jf kl{hluf; w hf]8Psf]hlufdf c:yfol jf :yfol ?kdf l; dfgf 3df{3/sf]gS; f kf; ubf{; /x :jLst lng' kg\$.
- ; flj s 3/ 6x/f kgM lgdfdf ubf{ hu ; Dd g}e]sf0{kgM lgdfdf ug{kgl ePdf ; 8s ; DaGwl afx?df pNny eP cg; f/ ; Jofs 5f\$ dfq kgM lgdfdf ug{kf0g\$.
- ; fj hlgf af6f?df s; h]klg cf^gf]3/af6 kmf/ dhf jf kpfu ul/Psf]kfgl 5f\$g kf0g]5g} .
- o; dfkb08df lj leG lfq -Zone_ x?df JolQmut 3/ jf cGo lj leG lsl; dsf ejgx? lgdfdf ubf{ ; f]ejgsf]prf0{lgwf{0f ul/Psfdf ; f]prf0{egbf dfly sg}klg lgdfdf sfo{ug{kf0g]5g} .
- sg}klg ejgsf]l8hf0g/n]; f]ejgsf]lgdfdf cj:yf ; k/lehg ug{kgl/ wglnf0{lgdfdf sfo{ ; DkGg ePsf]lg;; f kkt ug{; DalGwt gu/kflnsfdf lgj dg lbaf, ejg :jLst gS; f cg; f/ g} lgdfdf ePsf]egl l8hf0g stf\$]l; kmf/; kq k\$ ug{kf0g\$.

kvfhx? M

- ; a}k\$]sf ; 8s -df/ rNg]af6] sf]5pdf kvfh agfpbf clwstd prf0{% lkm6 ^ 0Gr xg' kg\$. % lkm6 ^ 0Gr egbf clnf]agfpg' k/df % lkm6 ^ 0Gr dfly leq b]vg]ul/ 808L, Pwn, slm6 hfnl /fvL ; DalGwt gu/kflnsfaf6 k} :jLst ln0{& lkm6 ^ 0Gr; Dd kvfh / t/jf/ nuf0{lgdfdf ug{; Sg\$.

Ij zif Joj :yf M

- ePsf ; a}ls; dsf ; 8sx?sf]s}b/}yfj f6 lgwf{/t b/l e}bf klg km/flsnf]ePdf ; f] ; 8s ; ldfgf s}5}pdf klg :yfol vfnsf lgdf}f sfo{ug{:jLs[t lb0g]5} .
- sg} ; 8ssf]xfnsf] ; ldfgdf g}k}m} 4 t{/sfn]Ps nf0gdf !% j f ; f] e}bf a9L 3/ k}m} 4 ?kdf ePsf sfod 3/x?sf]nf0gsf]jLrdf nf0g ldnf0{gofF3/nf0{lgdf}f ug{:jLs[t lbg ; lsg} . gofF3/ c}o 3/x?sf]k}m} ldnf0{dfq lgdf}f ug{lb0g}/ gofFlgdf}f xg]3/x?nf0{nf0g e}bf cuf8L Nofpg lb0g]5} . t/ dVo af6f}f]5}pdf o; kfj wfg cg' f/ ubf{af6f}f]/f06 ckm j]-ROW_ sfod xg g; Sg]ePdf o; kfj wfg cg' f/ agfpg lb0g]5} .
- dflysf a}fx?df h:tf] ; }JoJ:yf ul/P tfklg gu/ lj sf; ; ldltn]cfj Zostf cg' f/ x}k} ug{: Sg} .

Sof6ln} / tyf 3/ aflx/sf]l; 9L M

- 3/ agfp}f ; fj h}gs ; 8s tyf ; 8saf6 tf]sPsf] ; }Jofs; Dd s}6ln} / k:g]l; 9L ; k}k} 6}l, kfgl 6}l tyf e}of} agfpg kf0g]5} .

5t an] L cflbsf] ; Da6wdf M

- 5t tyf an]Lsf]kfgl cf^gf]hlufdf dfq v; fNg kf0g]5 tyf ; fj h}gs ; 8s 5}pdf kfgl v; fNg'kbf{clgj fo{?kdf hldg; Dd kf0ksf]JoJ :yf ug{k5} .
- cf^gf]kvf}x?df klg l5d}lnf0{jfwf xg u/L ; f]kvf}df an]Lsf]kfgl v; fNg kf0g]5} .
- ; A}ft :df/s pklf} / ; A}of l}f, pklf}df g}f kf; ug{l; nl; n}df :jLs[t lbg' kb{ gu/kflnsf] ; e}h}j df ; Da6wt lj zif1 ; lxtsf]Architectural Oversight Committee u7g ug{/ ; f]sldl6j f6 c}oog u/f0{sldl6sf]l; kmf/; df gu/kflnsf]:jLs[t lbg} .
- k/fgf]zx/L l}f / jf}nf]ldl>t a; f]f; pklf}sf]l; dfgdf /x}f lsQfx?df gofFlgdf}f]nflu :jLs[t lb} To; 7fpF/ cf; kf; sf]ejgx? ; d} c}oog ul/ k/fgf]zx/L l}f ePsf h:t} ejgx? /x}f]7fpFk/fgf]zx/L l}f]ldl>t k/fgf]j ; f]f; pklf} ; /x gofFlgdf}f ug{:jLs[t lbg ; lsg} .
- g}kfn ; /sfn]nfu"ul/g]lgdf}f ; Da6wL sg}klg Building Code j f dfkb08 o; dfkb08sf]cleGg c} xg} / dfkb08sf]sg}a}fnf0{sf7df8f}pkTosf gu/ lj sf; ; ldltn]gu/kflnsf / c}o ; Da6wt klfsf]/fo ; e}fj ln0{cfj Zostf cg' f/ ; }f}vg ug{: Sg} .

; 8s M

sf7df8f}pkTosf leq kg]lgdg cg' f/sf ; 8sx?df lgdg adf}hd ; }Jofs 5f8L lgdf}f sfo{ug{k} .

-s_ r}mky M

- o; ; 8sdf s[b|/y/ b]v bj }tkm{#! ld6/; Ddf :yf0{jf c:yf0{lgdf sf0{ug{kf0g}5g. t/rqmkydf kg[l]dg :yfgx?nf0{-hg gS; fdf b]y0Psf 5g\ xfn 3/x? lgdf e0; s\$]lfd sfod ug[/ ; f]lfd lgdfg; f/ 3/x? lgdf ug{lb0g}5g .
- dxf/fhu qml; #sf]s[b|lj Gbaf6 k] {tkm{!#% ld6/ / klZrd tkm{!)} (ld6/ leqsf]/f06 ckm j] s[b|/y/fb]v bj }tkm{!% ld6/ sfod ug[. sflndf6l -snsl:yfg_ qml; #sf]s[b|lj Gbaf6 pQ/ %^ ld6/ rqmkydf]klZrd tkm{!% ld6/ ; Dd sg}lgdf sf0{ug{glbg].
- sf\$Zj / qml; #sf]s[baf6 pQ/ tkm{rqmkydf]klZrd #)# ld6/ leq s[b|/y/ b]v !% ld6/ ; Dd lgdf sf0{ug{glbg].
- l; gfdwn lfd (!!) ld6/ nDaf0df rqmkydf]leq k\$ s[b|/y/fb]v !! ld6/ ; Dd lgdf sf0{ug{glbg].
- l; gfdwn qml; #sf]s[baf6 pQ/ k] {tkm{&% ld6/ / klZrd tkm{#\$ ld6/ qml; #sf]blf0f tkm{#)% ld6/df s[b|/y/faf6 !@ ld6/; Dd lgdf sf0{ug{glbg].
- uZfnf rfalxn lfd pQ/ blf0f u/L rqmkydf]k] {tkm{!=@& ls=d= / klZrd tkm{!=@#^ ls=d= df s[b|/y/ b]v !! ld= ; Dd lgdf sf0{ug{glbg].

-v_ /fhdfu{M

- ; 8s ljeuaf6 pkfosf leq /f06 ckm j]@% ld6/ tfl]Psf]; a); 8sx?sf]s[b|/y/fb]v bj }tkm{ @% ld6/; Dd :yf0{vfnsf lgdf sf0{ug{lb0g}5g .
- o; cftuf ; 8s ljeun /fhdfu{egl t\$]sf]; 8sx? -h:t}lqejg /fhky tyf cl/lgsf] /fhdfu{ sf]bj }tkm{s[baf6 bfofFaf0f@% ld6/ ; Dd :yf0{vfnsf lgdf sf0{ug{lb0g}5g .

cf6/on ; 8s -zvf ; 8s_

bxfosf ; 8s lfd s[b|/y/fb]v bj }tkm{!! ld6/; Dd :yfol vfnsf]lgdf sf0{ug{lb0g}5g M

- ! = snsl:yfg rf/ b]af6]sflndf6l lj i0fdt]sf]kh lqk/Zj / jfudt]sf]kh -yfkfynl_ sk08f]h - kNrf\$ - hfj nfv]h - nugv]h - ; ftb]af6]. rqmky; #sf]qml; # gv' vf]f e} kf6l xB]j Edtl; Dd .
- @ = lqk/Zj / l:yt >l % lqejg :df/s - gfuyfg - dxfsn :yfg / /Tgkfs{c; g hfg] rf/ bf]f6f]/fli60 gfr3/ - sfltky - lztn lgjf; rqmky qml; # - jf; jf/L xB] a9flgns07 dGbl/ cuf8lsf] kx/L rf\$; Dd.
- # = ngrf} 8p/L gh]ssf]ltg bf]f6f]- ; f]y\$]kf6l - lj i0fdtl kh xB]rqmkydf]qml; #; Ddf .
- \$ = yfkfynl - j fl]dt]sf]kh_ - l; xb/jf/ - k'tnl ; 8s - sdnfbl u0fz hfg]tlg bf]f6f]xfQL; f/ - hogkfn lrq3/sf]pQ/ k] \$f]ltg bf]f6f]- gf/fo0f :yfg - b/jf/ dfu\$]tlg bf]f6f]- sfltky - sz/ dxnsf] rf/ bf]f6f] Dd .
- % = ufzfnf rf\$ - d]lb]l - 1fgZj / - sdnkfy/L - Ps\$dl ejg - tlg wf/f kf7zfnf - >l % dx]b\$] ; flns; Dd .
- ^ = k/fgf]j fgZj / rf\$- ufzfnf rf\$; Dd .

- &= rfj ħ rfš - j fĶ - hfĶkf6l - ufš0f{uĶ - ; fv' Dd .
- *= lj i0fdtłsf] khaf6 klZrd tkm{df5f kfNg] kfĶ/L bĶĶ kĶ {tkm{rqmky; ušf] qml; u bĶĶ afnfh'sf] dflŷNff] ahf/ xĶ}lq; hl ; 8ssf]pkłosfsf]sf7df8f]ĤhNnfsf]l; dfgf; Dd .
- (= sflnd6l qml; u lqej g lj Zj lj Bfno uĶ - blłf0f sfnłsf]kflsĔ :yn; Dd .
- !)= Pšfġt šgf -; f6f_ - egld08k rqmky xĶ}vfB ; :yfgsf ufĶfd; Dd .
- !!= hfj nfvdĶ - nugvdĶ - ; ftbĶĶaf6f]- vdn6f/ - xl/l; l4 - yĶ - afBĶufĶ - lš6gl xĶ}ufĶfj /l s08; Dd .
- !@= rqmky - 0df8fĶ - ; fgufĶ - nē"dxfnldl rfĶ xĶ}nfd6f/; Dd .
- !#= ; ftbĶĶaf6f] rqmky qml; Ĕ - 66Ķfł6 9fĶĶflx6l - ; gfsfĶ - yĶfĶ - kof^a\ufĶ - nĶ]ltnĶj / xĶ}; /:j tl s08; Dd .

sgš6 ; 8s -kĶfvf ; 8s

bĶfosf ; 8s lĶdf sĶb|/vfbĶĶ bĶ}tkm&ld6/ ; Dd :yf0{vfnsf lgdf0f ug{lb0g]5g Ĥ

- != vdn6f/ - wfkfvĶ xĶ}7fĶ] Ddf .
- @= sfnldf6l rf/ bĶĶaf6f]- txfnrn - 5fpgl - lsd8fĶ - :j ode' -bxrfš hfg]af6f] rqmkysf]qml; u; Dd .
- #= :j ode' -kĶ/L rfšL jg:ynl dflwofłds lj Bfno rqmkysf]qml; u; Dd .
- \$= :j ode' -kĶ/L rfšL lj i0fdtłsf]kh -zĶĶf euj tl dlG6/ glhs_ ; Dd .
- %= 7dĶ -j fnfh' hfg]5l6g]ltg bĶĶaf6f] ulłsf]kfvf - rqmky; ušf]qml; u; Dd .
- ^= cdĶ/sl /fhb'tsf]lgj f; glhs ltg bĶ]f6f]- sdnfbl u0fz:yfg ; /:j tl ; bg cuf8łsf]ltg bĶĶaf6f] Dd .
- &= afuahf/ - l8nl ahf/ - dĶlb] l j fgĶj / - aflđtłsf]kh - l; gfdu; Dd .
- *= sk08fĶ -sfgb] tf :yfg_ zĶĶf ej gsf]9fšf, kNrfš -gf/fo0f xĶĶn cufł8sf]ltg bĶ]f6f] ; Dd .
- (= em; lvĶĶsf]rfĶĶaf6f]bĶĶ blłf0f tkm{xĶ}wf]l3f6 - rqmky; ušf]qml; u; Dd .
- !)= ef6e6Ķl - afnĶ]f6f/ - kĶ/L tflnd sĶb|-dx/fhuĶ_ sf]ltg bĶ]f6f] Ddf .
- !!= euj tl j xfn -dG6l/_ ; fgf]ufĶ/g - l; kmn - rfj ħ rfš -rqmky qml; u_ ; Dd .
- !@= zvdhsf]kh - cĶt/flĶ60 ej g - k/fgf]j fgĶj / rfš; Dd .
- !#= dlxfn kĶ]złf0f sĶb|-hfj nfvdĶ_ rqmky qml; u; Dd .
- !\$= nugvdĶ j ; kfs(dxfnldl:yfg rqmky qml; u; Dd .
- !% ef6e6Ķl dG6l/ lj zfn gu/ - rqmky qml; u; Dd .
- !^= hfj nfvdĶ Pšfġt šgf xĶ}rqmky qml; u; Dd .
- !&= gfukfĶ/L ltg bĶĶaf6f]- gS; fn rf/9u]- ulxw/f - /fh; ef ; efklł lgj f; afnĶ]f6f/ -/fı6«aš uĶ_ ; Dd .
- !*= hfj nfvdĶ, rfĶĶaf6f]- 0Gwg ; :yf l8kf]- lrl8ofvfgfsf]pQ/ xĶ}wf]l3f6 kĶ/L rfšL; Dd .
- !(= l8Nnlahf/ kĶ/L kfĶ]6sf]tlgbĶĶaf6f]- rf/vfn - 1fgĶj / kĶĶ kDk - euj tl axfn - ef6e6Ķl afnĶ]f6f/ - kĶ/L tflnd sĶb|dx/fhuĶsf]tlgbĶĶaf6f] Dd .
- @)= kf6g 9fšf bĶĶ sfk08fĶĶsf]ltg bĶ]f6f] Dd .
- @!= afnfh' -rqmky qml; u_ bĶĶ afnfh' ahf/ xĶ}gu/kflnsf l; dfgf; Dd .

@@= kf6g afnsdf/L :yfg xB}rqmkysf]qnl; #; Dd .

@#= lj zfn gu/ wf]L vf]hf -eTs\$]kh_xB}rfj lxn rf} -lj B't kflws/Of sfoffno_ ; Dd .

@\$= wf]L3f6 ; [6d]Lh :sh kNrf\$ bdsn; Dd .

lkm8/ -; xfos ; 8s_

b}xfosf ; 8s lf]df s[b]/]f b]v b] }tkm(%=% ld6/ ; Dd :yf0{vfnsf lgdf} sfo{ug{lb0g]5g} M-

!= afnj f6f/ -klj q j s}k_ 68fn b]L lj zfn gu/; Dd .

@= dfg ejg j ; :6k xB}dx[b]o]fnosf]k' {xB}kNrf\$ kf]/L -lrN8g kfs[; Dd .

#= cGt/f[60 ; Dd]hg ejg - l; #b/j f/, /fli60 clen]vno; Dd .

\$= l8Nnlahf/ -rf]af6]sfnl\$yf - kt nl ; 8s -kBdf]ho glhssf]ltgb]f6f] ; Dd .

%= dfg ejg j ; :6k - lhNnf sfoffno - kf6g 6l8v]h -nugv]h_ ; Dd .

^= nugv]h dxfnldl :Vffg ; xsf/L sfoffno - ; ftb]af6f] Dd .

&= ; fgkf rf]f/f]- sfnf]em]hE]kh -6\$'lg:sg] ; Dd .

*= kf6g 9f\$ kf6g SofDk; sf]xftf - rfsk6 j fudtl\$]lsgf/f; Dd .

(= sf]k08f]h -dh ; 8s_ ul; #fn - 0Ghl]gol/# c]loog ; #yfgsf]pQ/ xB}rfsk6sf]df} / rNg]; 8s; Dd .

!)= kNrf\$ SofDk; -0{c=; #yfg_ cuf8laf6 j v08f]h - xf; fkftf u0fz :yfg xB} ; fgkf l6sf lj Bf>d ; fgkf; Ddf.

!!= j v08f]h - xf]n - ; dl6 - sf]k08f]h cf]k]nf] Dd .

lj zif ; 8s

!= /fhb/j f/ blifof dh9f\$; /:j tl ; bg - lj B't lj efu eb\$fnl xB}l; #b/j f/ dh 9f\$; Dd ; 8ssf]b] }tkm[s[b]/]f af6 !% ld6/ leq :yf0{vfnsf]lgdf} sfo{ug{lb0g]5g} .

@= /fhb/j f/sf]pQ/ / k' {k\$]sf]af6f\$]s[b]/]faf6 !% ld6/ ; Dd :yf0{vfnsf]lgdf} sfo{ug{lb0g]5g} .

#= gf/fo0f]x6l b/j f/sf]pQ/ k' \$] sf] u}lw]f/f - 6#fn lf]df s[b]/]f b]v b] }tkm[* ld6/; Dd :yf0{vfnsf lgdf} sfo{ug{lb0g]5g} ; fy}:jLs[lgb]zt hluf lj sf; of]hgfn]lgwf]/t ; 8ssf]rf\$fo{k]5 b] }tkm[Ps Ps ld6/ 5f8L dfq lgdf} ug{kf0g\$.

slltK/ gu/kflnsf leq kgI lgDg cg' f/sf ; 8sx?df lgDg adfllhd ; 6Jofs 5f8L
lgdf0f ug{kg5 M-

!= cf6V/on ; 8s - zfvf ; 8s _

bxfosf] ; 8s lfgdf s[b|/yfb]v bj }tkm(! Id6/ ; Dd :yfol vfnsf]lgdf0f sfo{ug{lb0g]5g M-

- sfndf6L qml; # lqej g lj Zj lj Bfno blif0fsfnl ; 8s .

@= kzfvf ; 8s - sg\$6 ; 8s _

bxfosf ; 8s lfgdf s[b|/yfb]v bj }tkm& Id6/ ; Dd :yfol vfnsf]lgdf0f sfo{ug{lb0g]5g M-

- lq=la= u6 gofahf/ kfuf braf6f]guf6 braf6f]eTsKf6L kknfn kl:t:yfg; Dd
- slltK/ I/E/f8 - o; rqnky leq xfn 3/x? lgdf0f e0; s3f kSsl 3/x?sf]xsdf xfn /x3f
Building Line oyfj t sfod xg]. _
- vf; L ahf/ ; funxl6km Itg yfg lj i0fb]L; Dd
- vf; L ahf/ j 8f g=# ejg sfofno 9Nkf ; 8s 5uf6 eTsKf6L hfg]af6f] Dd
- ; fun lknaf6 lrxfg af6f]ltgyfg; Dd
- lq=la= Nofaf]6/L :sh gofahf/; Dd

#= lkm8/ ; 8s - ; xfos ; 8s_

bxfosf ; 8s lfgdf s[b|/yfb]v bj }tkm%- Id6/ ; Dd :yfol vfnsf]lgdf0f sfo{ug{ lb0g]5g M-

- slltK/ I/E/f8 dun :sh 6dfenf rraf6f]rf6gl rf3 sf7df8f]I/E/f8; Dd .
- slltK/ I/E/f8 gkfn efiif Ps8DL rf/braf6f]x6]ldt]L kh lqej g /fhky; Dd .
- lj Zj /fli60 df=j = 9Nkf-; Nofg:yfg bxfn uf6-lj i0fb]L ltgyfg; Dd
- slltK/ gofahf/ kfuf 9f3; L - ; flns - efhun - rraf6f/ u6; Dd .
- efhun-; drf kfuf - blif0f - sdn kfyl/L _ rf/3/] Dd .
- bxg -sdnkfyl/L - - tn kfyl/L _ z3f - nug6fh - 6f6x blif0fsfnl rg sf/vfgf - avDa' -
nug6fh; Dd .
- rraf6f/ /fd axfb/ s6j fnsf]lrof k; n -u?8 :yfg - blif0fsfnl ; 8s; Dd .
- blif0fsfnl ; 8s rraf6f/ gkfn kw]f cfbgfy :sh s6j fnsf]3/ lknaf6 blv rraf6f/ u6 hfg]
af6f] Dd .
- ufDrf - emh kfyl/L af6f]- 0sf e3f - lj i0fb]L ltgyfg 6kVof]hfg]af6f] Dd - dR5]uf6 _ .
- slltK/ I/E/f8 lx/f1fgsf]3/ x6]clhdVof] Dd .
- cd[gu/ cf]fnf]af6f]j 8f !\$ sf=gkf= l; dfgf - I/E/f8 kh ; Dd lg:sg]af6f] Dd .
- eTsKf6L kknfn hfg]braf6f]- l; tf/fd uf3h ldNs hfg]af6f]- bw kfyl/L ; f0afaf :sh
rf] - af3e]j :sh - kknfn hfg]af6f] Dd .

\$= PS;] ; 8s -s_

bxfosf ; 8s lfgdf s[b|/yfb]v bj }tkm(\$ Id6/ ; Dd :yfol vfnsf]lgdf0f sfo{ug{lb0g]5g M-

- 6dfanf rfbgl rf3 - km]g{/ k; n cf]fnf]- I/E/f8; Dd

- rfbgl rf\$af6 - **Child care** :sh - chdfVof]hfg]af6f] Dd .
- /fhkmlg{/ - klZrd af6f]- chhdfVof]hfg]af6f] Dd .
- 6ð^anf rf\$af6f]- lj i0f' b]L xllj kf]6 ; Ddsf]af6f] Dd .
- 6ð^anf rf\$af6f]- clhdfVof]hfg]af6f] Dd .
- cd[gu/ hfg]cf]fnf]bf\$af6f]- xf06[; gsf]af6f]- rfbgl rf\$af6 cfpq]af6f] Dd .
- slltk{/ 9Nkf rr{-ufDrf; Dd .
- 5ufp - hfvf ; 8s - hfvf vfk' 6ðfsl - lxdfn sfs[- j 8f !_ cWofsf 3/ xB]- eTskf6l ; 8s; Dd .
- !! g+j 8f sfofnoaf6 pQ/ k] {; drf 6fh; Dd .
- !! g+j 8f sfofnoaf6 blif0f k] {bxg - sdn kf]/L _ ; Dd .
- efhun ; drf hfg]06fufh bf\$af6f\$af6 06fufh - u?9:yfg; Dd j 8f g+!* efhun vf=kf= 6ðfsl - bw kf]/L _ af6 j 8f g+& rDkfb]L .

%= PS;] ; 8s -v_

bxfosf ; 8s lfgdf s[b]/yfb]v bj }tkm(# ld6/ ; Dd :yfol vfnsf]lgdfvf sfo{ug{lb0g]5g M

- 6ð^anf rf\$af6f]- lq=a= hun hfg]af6f]- lq=a=a= af6f] Dd .
- e]j ckm; f k] - k] {xB}lq=a=a= af6f] Dd .
- /fhkmlg{/ - k] {pQ/ - lzj fno - l; tf cfkn kDk hfg]af6f] Dd .
- lj i0f' blj xllj kf]6 - blif0f klZrd xB}clhdfVof]hfg]af6f] Dd .
- cflhdfVof]j /kn xfn uf]f]af6f]xB}- ldt]L kh lg:sg]af6f] Dd .
- cflhdfVof]- klZrd xB}/fkj]6fj / ; w\$]af6f]xB}gkfn efiif PsBdl -ldt]L kh hfg]af6f]_ .
- gfulxl6sf]af6f]- ; Nofg:yfg hfg]bf\$af6f] Dd .
- lxl6km klZrd blif0f - sf/w ; Ddsf]uf]f]af6f]- ; Nofg:yfg hfg]7f8f]af6f] .
- t/Vof]9Nkf - sf/9rf ; Ddsf]7f8f]af6f] .
- t/Vof]9Nkf - pQ/ efnhf ; foldsf]3/ - slttk{/ l/E/fB v; L ahf/; Dd .
- t/Vof]9Nkf - pQ/ k] {- ; feif ej g v; L ahf/; Dd .
- t/Vof]9Nkf - k] {xB}- sl=df=j=:sh - aflx/L ufB cf]fnf] Dd .
- t/Vof]9Nkf - gufB s[if dfly eTskf6l af6f] Dd .
- t/Vof]9Nkf - gufB rf0lghsf]3/ k5f18 xB}- z]fgf/fo0fsf]3/ - gufB eTskf6l ; 8s; Dd .
- ; Nofg:yfg dflyNnf]ufB - tn vgn ufB xB}- lj i0f' b]L ltgyfg hfg]bf\$af6f] Dd .
- rDkfb]L ; feif k; n tn - klZrd - dR5gf/foof hfg]af6f] .
- rDkf b]L j 8f g+* sfofno hfg]- l/; fB}hfg]af6f]- klknfn kl:t:yfg; Dd .
- eTskf6l - lj i6 ufB - l; d vfk dxfg; Dd .
- gufB bf\$af6f]- l; s5HkknafB afB; Dd
- gufB :sh - l; s5Hhfg]af6f] Dd .
- l; s5Hhfg]af6f]- Zofd dxhg]sf]_ 3/ - blif0fsf] hfvf vfk' 6ðfsl hfg]uf]f]af6f] . - 5ufp vf=kf= wf/f; Dd _
- 5ufp - gufB - al4sf]3/ -gufB lraf; Dd .
- kfEif l; gdf xn - klZrd - lrv' -l; s5Hhfg]af6f] Dd .
- gufB l/e/Eofnl - lrv' -pQ/ - k] { kfEif hfg]dh af6f] Dd .
- gofFahf/ - efhun xB}- kfEif rfEif/ uB hfg]af6f] Dd .
- gkfn kw]faf6 blif0f klZrd xB}gj lglde dfB/ af6f]- pQ/ k] {cflbgfy hfg]v8nsnf; Dd .
- gofFahf/ - efhun lrxfg - efhun 6ðfsl; Dd .
- lxdfn l; d[6 sDkgl b]v klZrd dflyNnf]uB; Dd .

^= PS;] ; 8s -u_

bxfosf ; 8s lfgdf s|b|/yfb|v bj}tkm(!@% ld6/ ; Dd :yfol vfnsf]lgdf sf{ug{lb0g]5g M-

- gu/kflnsf lfg leqsf @)) ld= ; Dd nDaf0{ePsf xfnsf uf]af6f}?
- lxl6km ; fun - ; Nofg:yfg hfg]af6f]- blifof _ ; Dd .
- lxl6km ; fun sf65f dxh6sf]hlufaf6 klZrd - ; Nofg:yfg hfg]af6f].
- guf z]fg/fo0sf]3/sf]blif0df kg]af6f]af6 pQ/df - k1k ; bg :shsf]hllfsf]k] {x6} sl-df=j= hfg]af6f] Dd .
- efhun lrxfg - :gjhkg sfk ^ofS6/L - kfEf af6f] Dd .
- efhun lrxfg - kfEf df=j= :sh blifof - rfe/ u6 hfg]af6f] Dd .
- efhun kfEf - rfe/ u6 af6f] alr lt/sf uf]af6f} dhdfg k; n - 06fufh hfg]af6f]
- efhun lrxfg - kfEf df=j=:sh - l; wf blifof rfe/ u6 hfg]af6f] Dd .

&= PS;] ; 8s -3_

bxfosf]; 8s lfgdf s|b|/yfb|v bj}tkm(!@% ld6/ ; Dd :yfol vfnsf]lgdf sf{ug{lb0g]5g M-

- gu/kflnsf lfg leqsf !)) ld= ; Dd nDaf0{ePsf xfnsf uf]af6f}?

lj lj w M

- o; dfkb08df plnlvt lj ifodf Joj :yf u/L lg0f6 ug{kbf}j f g; d]6Psf lj ifo / a6fx?df ; Dal6wt lgsfosf]kltlglwtj /xsf]klj lws ; ldltsf]l; kmf/zdf sf7df8f]pkTosf gu/ lj sf; ; ldltn]lg0f6 lbg5 .
- of]dfkb08 nfu' xge6bf klxng}sfod ePsf]hlufsf] lfgkm / dfx8f o; dfkb08n]lgwf{Of ul/Psf] G6td lfgkm / dfx8f e6bf sd eP tfklg To:tf hlufdf dfkb08n]lj le6g lfg pklfqsf]nflu tf]sPsf FAR, uf]p08 se/h, ; 6 Aofs h:tf kl/lw leq /lx lgdf sf{ug{kf0g5 .

kl/R5D #

dllok/ lyld gu/kfinsf lfg leq ul/g]lgdf0f ; DaGwl dfkb08

kl/R5b

- o; kl/R5bdf g; dlpPsf lj ifox?df kl/R5b ! sf]; fdfGo Joj :yfdf plNnlvt kfj wfg nfu"xbf _

o; gu/ leqsf]k/Dk/fut dflns snf, ; #s[t Pj +ej gsf] ; Argf ; Afof u/L gu/sf] efl]ts k] fvf/ lj sf; lj :tf/ ubf :j :y ; kmf jftfj/Of sfod u/L ej gsf] ; /lft lgdfqsf nflu gu/ lfq leqsf] ; DkOf{ e"-efunf0{ gS; fdf b]fOP cg; f/ lgDg adfl]hd lfq lj efhg u/L lgdfq ; DaGwl dfkb08 ; d] lgwf{Of ul/Psf] .

- s_ k/Dk/fut cfjf; lo lfq
- v_ ; #yfut lfq
- u_ lj sfl; n lfq
- 3_ ; /lft lfq
- a_ xl/t lfq

-s_ k/Dk/fut cfjf; lo lfq -Traditional Residential Zone_ M

o; gu/ leqsf]afnsdf/L , rkfrf], gubz , afBsf]k/Dk/fut dflns snf / ; #s[tn]kOf{lj sl; t 3gf cfjf; lo ejg tyf d7 dlGb/ cflb ePsf]-@)! ; fndf gkl gePsf] e"-efunf0{k/Dk/fut cfjf; lo lfq elg tfl]sPsf] . o; lfqsf]k/Dk/fut ej gsf] ; Afof ; DaGwl Joj :yf / ejg lgdfqsf] ; Argf / dfkb08 lgDg cg; f/ lgwf{Of ul/Psf] M

- != o; lfqdf k/Dk/fut dflns gj f/L z]lsf]ejg ; Argdf km/s xg]u/L sg}klg ejg kgM lgdfq, dd, ; wf/ cflb ug{kf0g]5g . k/fgf]ejg e]sf0{kgM lgdfq ug{k/df k/fgf]ejg e]sfpq k} { :j ls[t lng' kgf .
- @= k/Dk/fut ejg e]sf0{kgM lgdfq ubf{ ; flj s k/fgf]ejgdf ePsf] ; a)k/Dk/fut snfkOf{sf7sf j :tx? klxn]h:t}gof+lgdfq xg]ejgdf kgM kof]df Nofpg' kgf .
- #= o; lfqdf jf:t'snfsf j :tx? oyfj t kof]u u/L kgM lgdfq ul/g]gof+ej gsf]gSzf kf; b:t/df &% kl]tzt; Dd 56 lbg / dfx8f lgdfqsf] nflu cfj Zos t]h of 06f d]w] @% kl]tzt 06f j :tut cgbfg lbg / snf]ds j :tsf]dd ; ef/df cfj Zos kf]j lws tyf cfly\$; xof]u ; d] pknAw u/f0g ; lsgf .
- \$= o; lfqsf]nflu clwstd u]p08 se/h, clwstd tnf / prf0{lgDgfg; f/ tfl]sPsf]5 M

l; =g+	ej gsf]lsl; d	clwstd u]p08	clwstd prf0{	clwstd tnf	^nf] xf06
!=	vfnl hllufdf ejg agfpg	*)%	!)=(dl6/	\$)=% dl6/
@=	k/fgf] ej gn] rrf] 7f]df k/fgf]ejg e]sf0{agfpg]	!))%	!)=(dl6/ - e-ofE 5f]g]/ kfgl 6df]L ; d]_	\$)=% dl6/
#=	dfx8fsf] k5f18kl\$ #=% dl6/ hDdsf]hlluf ePdf	!))%	!)=(dl6/	\$)=% dl6/

%= gofFej gsf]lkn]y prf0{af6f]s]b]la6bsf]prf0{af6)=#) dl6/df ga9f0{lgdfq ug{kfpgf .

- ^= e-of^asf]:nfk a9ldf \$% l8u| tyf e-of^asf]rf8f0{slDtdf)=() dl6/ xg]u/l agfpg' kg5 .
- &= ej gsf]; Dk0f{aflx/L cfj /0fsf]efudf Plnj zg cf/= ; l=; l= efux? ; d]nf0{06fsf]uf-xf6 5fkl agfpg' kg5 . aflx/L efudf knfi6/ sfo{ug{kf0g]5g} .
- *= ej gsf]; Dk0f{aflx/L cfj /0fdf cg; rL ^ df byfOP cg; f/ k/Dk/fut gjf/L z]n Pj +cfsf/ k\$fsf]sf7sf Eofn 9f\$fx? /Vg' kg5 .
- (= j fbhl ; flj s adf]hd j f cfkmg}hllufdf kg]u/l agfpg' kg5 . ej gsf]bf}f]tnfdf clwstd)= () ld6/sf]afbh / 9Ns\$]5fgf afx\$ cf/= ; l= ; l= 6k -5Hhf_ lgdf0f ug{kf0g]5g} .
- !)= ej gsf]j n]L 5fgfsf ; fy}e'ofE 5f]kPsf]efu ; d]t @% l8u| blv #) l8u|; Ddsf] 9Nsf0df cyjf Flat 5fgf agfpg ; lsg5 . ej gsf]5fgf df6f] lem6L j f fonn]5f]k ; flj s adf]hd j f cfkmg}hldgdf kg]u/l dfq agfpg' kg5 .
- !!= ; flj s adf]hd kgM lgdf0f xg]df afx\$ gof+lgdf0f xg]ej gdf em6n tyf e06lnzg /Vg lgdf0f xg]ej gaf6 slDtdf !=% ld6/ hlluf vlnf 5f\$]xg' kg5 .
- !@= gofFlgdf0f xg] ej gsf] sg} klg efun] l5d\$lsf] hlluf, ; fj hlgS af6f] cflb vNnf efunf0{ dflylt/af6 5f]g kf0g]5g} . t/ bfof+afosf 3/x?; u dfx8f ldnfg xg]u/l :jLst lbg ; lsg5 .

-v_ ; #yfut lfg -Institutional zone_ M

lj leG ; /sf/L tyf cw{ /sf/L ; 3 ; #yf cflb sfofnox? /x\$]e-efunf0{ ; #yfut lfg elg tfl]sPsf]5. o; lfgdf lgdf0f xg]; #yfut sfofno ej gnf0{ ; 'JoJ:yt u/fpg lgdf0f xg]ej g cflbsf]dfkb08 lgDg cg; f/ lgwf{0f ul/Psf]5 M-

!= o; lfg]sf]nflu clwstd ufp08 se/h, clwstd tnf / prf0{lgDgfg; f/ tfl]sPsf]5 M-

l; =g+	ej gsf]lsl; d	clwstd ufp08	clwstd prf0{	clwstd tnf	~nf/ xf06
!=	vfnl hllufdf ej g agfpg	\$)%	!% dl6/	%	@=& dl6/

kgZrM e-ofEsf] se/, kfgl 6dfEsl tyf :nf]kE 5fgf ; lxtsf] nflu yk @=\$) ld6/ prf0df lgdf0f ug{; Sg5 .

@= ; 8ssf] dflysf] dWo /yfsf] clwstd prf0af6 snf]kq]; 8sdf)=\$% ld6/, ufejh ; 8sdf)=^) ld6/, sRrl ; 8sdf)=&% ld6/; Dd prf0df ej gsf] lkn6y agfpg ; lsg5 . lgdf0f:yn ; 8se6bf xft]f] jf prf0df ePdf 9n lgsf; ; rf? ?kn]; #fng xg] lsl; dn] ej gsf] lkn6y agfpg' kg5 .

#= ej gsf] Gogtd rf8f0{@=\$) ld6/ xg' kg5 . t/ ej gsf] nDaf0{/ rf8f0{sf] cgkft %M e6bf a9L xg' x6g . olb rf8f0sf] cgkftdf nDaf0{ % u0ff a9L ePdf clwstd %) ld=sd=sf] expansion joint /Vg' kg5 .

\$= ej gsf] k]o\$ sf]fx?df /flvg] vNnf em6n 9f\$fx? tyf e]6nZgsf] efu ; f] sf]fsf] e06n] 9fs\$] lfgkmsf] Gogtd !% kl]tzt jf Gogtd lfgkm)= # j u{ld6/ xg' kg5 . o; df vfl]g glDNg]l:y/ em6n tyf e]6nZgsf] efu ; dfj z ul/g]5g} .

- %= ejg alrsf]6k clwstd)= ^) ld6/ tyf 5fgfsf]nflusf]clwstd)=() ld6/ ; Ddsf] xg' kg\$.
- ^= lgdf{0f ug]ej gaf6 kn6df lgDg cg' f/ vNnf hluuf -; }Jofs_ 5f]8Psf]xg' kg\$. ; }Jofs lgwf{0f ubf{5Hhf tyf 5fgfsf]afix/ lgsflnPsf]efu afx\$ ej gsf] ; a)k\$ f/sf]afix/ lgl:sg] efux? h:t)afbf]L, Sofl66lne/df agf0Psf]sf]7f ; d] ; dfj z xg\$.
- &= af6\$]s]b|/yfaf6 5f\$g' kg]eefu (ROW) / ! ld6/ ; }Jofs 5f8g' kg\$. t/ bfaf6df kg] :yfgsf]xsdf cltI/Qm rf\$0\$]nflu ; 8s lj efun]tfl]sPsf]dfkb08 nfu"xg\$.
- *= ej gsf]bf6f af6ftkm(kn6 hluufsf]l; dfgfaf6 #=) ld6/ hluuf 5f\$g' kg\$ / ej gsf]k5f8l tkm(kn6 hluufsf]l; dfgfaf6 #=) ld6/ hluuf 5f\$g' kg\$.
- (= kn6 hluufsf]l; dfgfaf6 Gogtd # dl= hluuf ; }Jofs 5f8l dfq ejgdf em6n 9f\$ tyf e]6n z g /Vg kfg\$. k]o\$ ej gsf] ; }Jofs 5\$5\$}xg' kg\$.
- !)= ; jf/L kf]s]sf]lgldQ kn6 hluufdf Gogtd @) kl]tzt hluuf 5f\$]sf]xg' kg\$.

-u_ lj sfl; n lf\$ =Developing Zone_ M

o; gu/ l; df leq c6o lj lj w lj sf; lj :tf/sf]cj :yfnf0{cem}; Jojl:yt agfpg o; lf\$sf e"efunf0{lgDg cg' f/ pklf\$df lj efhg ul/Psf]5 .

- c_ cfj f; lo pklf\$ -cf_ Jofkf/ls pklf\$
- 0_ cf\$fl]us pklf\$ -0{ lj z]f of]hgfut pklf\$

-c_ cfj f; lo pklf\$ - Residential sub zone_ M

k/Dk/fut cfj f; lo lf\$; :yfut lf\$, Jofkf/s pklf\$, cf\$fl]us pklf\$, lj z]f of]hgfut pklf\$ j fx\$df ejg lgdf{0f ug{/f\$ gnuf0Psf lf\$?nf0{cfj f; lo pklf\$ elg tfl]sPsf]5 .

!= o; pklf\$df lgdf{0f xg]ej gsf]clwstd uf]p08 se/h, clwstd prf0{lgDg adf]hd lgwf{0f ul/Psf]5M

l; =g#	ej gsf]lsl; d	hluufsf]lf\$km	clwstd uf]p08 se/h	clwstd prf0{	clwstd tnf
!=	cfj f; lo	\$ cfgf; Dd	&)%	!=\$ dl6/	\$
@=	cfj f; lo	\$ cfgf e6bf a9L	^)%		
#=	cfj f; lo sf]hf\$	-	^)%		
\$=	; :yfut ejg	-	\$)%		
%=	l; gdf, xn, lyP6/, ; efux	-	\$)%		
^=	; fgf tyf 3/h' pBfl] ; Da6wl ejg	-	\$)%		
&=	Jofkf/s sDkn\$;	-	\$)%		

- @= Kof/flk6; \kvfñ ; lxt ejgsf]clwstd prf0{!=\$ ld6/ e6bf a9L lgdf0f ug{kf0g]5g} . t/ e-ofE 5f]g]efu kfgl 6\$! tyf :nflkE 5fgf ; lxtsf]nflu yk @=\$) ld6/ prf0{lgdf0f ug{kf0g} .
- #= 5fgf; Dd hfg]e-ofE 5f]kg]cltI/Qm efu afx\$ hDdf \$ tNnf ; Ddf lgdf0f ug{kf0g} .
- \$= cfj f; lo kpf]hgsf]nflu ejgsf]Gogtd I; lnEsf]prf0{@=# ld6/ / cGo kpf]hgsf]nflu lgdf0f xg]ejgsf]nflu @=& ld6/ prf0{xg' kg} .
- %= ; 8ssf]dWo /yfsf]prf0{f6 clwstd sfnf]kq; 8sdf)=\$% ld6/, ulj ñ ; 8sdf)=^) ld6/, slRr ; 8sdf)=% ; Dd prf0df ejgsf]lkngy agfpg ; lsg} . lgdf0f:yn ; 8s e6bf xf]f]f prf0df eP 9n lgsf; ; r? ?kn]; #fng xg]lsl; dsf]ejgsf]lkn6y agfpg' kg} .
- ^= ejgsf]Gogtd rf0{@=\$) ld6/ xg' kg} . t/ ejgsf]nDaf0{/ rf0\$]cgkft #=! e6bf a9L xg' xg} . olb rf0\$]cgkftdf nDaf0{# uoff a9L ePdf %) ld=ld= sf]lgdf0f hf0{/Vg' kg} .
- &= ejgsf]k]o\$ sf7fx?df /flvg]vNnf Eofn, 9f\$ tyf e]6n}zgsf]efu ; f]sf]7fsf]e0h]9flsPsf] lqkmsf]Gogtd !% kltzt j f Gogtd lqkmm)=#) j u{ld6/ xg' kg} . o; df l:y/ Eofn e]6n}zgsf]efu ; dfj z ul/g]5g} .
- *= ejg alrsf]5Hhf clwstd)=^) ld6/ tyf 5gfsf]nflu clwstd)=() ld6/ ; Ddsf]xg' kg} . ejgsf] cGo afx/ lgsflng] efux?sf xsdf ulp08 se/h / ; 6 Aofs ; DaGwdf t]sPsf] dfkb08 nfu"xg} .
- (= ; 6Jofs lgwf0f ubf{6k tyf 5fgfsf] afx/ lgsflnPsf]efu afx\$ ejgsf] ; a}k\$ /sf] afx/ lgl:sg]efux? h:t}afbhl, Sofl66lne/df agf0Psf]sf]f ; dt ; dfj z xg} .
- !)= cfj f; lo ejgsf]lgdf0f]nflu af6f]s]s0b|/yaf6 5f8g' kg]eëfu (ROW) / ! ld6/ ; 6Jofs 5f8g' kg} . t/ ; :yfut ejg, ; ef ejg, lj leGg k\$ /sf] xn, 3/h' pBfu, Aofkl/s ejgsf] lgldQ sfod ePsf] af6f]s] rf0sf] /yaf6 #=) ld6/ ; 6Jofs 5f8g' kg} . bfaf6df kg] :ygsf]xsdf cltI/Qm rf0\$]nflu ; 8s lj efun]t\$}dfkb08 nfu"xg} .
- !!= cfj f; lo ejgsf]nflu ejgsf]bfof+af0tkm[Eofn 9f\$ /Vg kn6 hluvsf]l; dfgfaf6 !=% le6/ hluuf vNnf 5f8g' kg} . Eofn 9f\$ g/flvg]eP kn6 hluvsf]l; dfgf; Dd lgdf0f ug{kf0g} . t/ ; :yfut ejg, ; ef ejg, xn, 3/h' pBfu, Aofkl/s ejg cflbsf]xsdf eg]kn6 hluvsf] l; dfgfaf6 Gogtd #=) ld6/ hluuf vNnf 5f8g' kg} .
- !@= cfj f; lo ejgsf]lgldQ kn6 hluvsf]l; dfgfaf6 Gogtd !=% ld6/ hluuf vNnf 5f8L dfq ejgdf Eofn, 9f\$ tyf e]6n}zg /Vg kfgp} . t/ ; :yfut ejg, ; ef ejg, xn, 3/h' pBfu, Aofkl/s ejg cflbsf]xsdf kn6 hluvsf]l; dfgfaf6 Gogtd #=) ld6/ hluuf vNnf 5f8g' kg} . t/ Pp6}kn6 hluufdf Pse6bf a9L ejgx? lgdf0f ePsf]jf ul/g]eP k]o\$ ejgx?df vNnf Eofn, 9f\$, e]6n}zg /Vg 5\$5\$}; 6Jofs 5f8Psf]xg' kb} .

!#= ; :yfut ej g, ; ef ej g, xn, 3/h' pBfU, Aofkf/Ls ej g cflbsf] ; j f/L kflsEsf] lglDQ Kn6 hluufdf Goğtd lfgkmm @) kltzt hluuf 5f8sf] xg' kg5 .

-cf_ Aofkf/Ls pklfg M

Aofkf/ Joj ; fo clws xg] ; lj wfoQm c/lgsf] /fhdfu{ bfofFj fofBf] sxl e"efunf0{ Aofkf/l/s pklfg egl tflsPsf5 .

!=o; pklfgdf lgdff xg]ejgsf]lfgkmm tyf prf0{lglDg adfllhd xg' kg5 M

l; =g+	ejgsf] lsl; d	hluufsf]lfgkmm	clwstd ulp08 se/h	clwstd prf0{	clwstd tnf
!=	cfj f; lo	\$ cfgf; Dd	&)%	!% dl6/	%
@=	cfj f; lo	\$ cfgf eGbf a9L	^)%	!% dl6/	% - e-ofE 5fllg]efu afx\$ _

@= ejgsf]lkn6y prf0{eGbf dgl kflsE koflsgsf]nflu Pp6f cltl/Qm j] d06 lgdff ug{; lsg5 . To: tfltnfsf]prf0{Goğtd @=&) / kj z yofk 4f/ cflm}hluufdf xg' kg5 .

#= cfj f; lo koflsgsf]ejgsf]nflu @=#) ld6/ / cGo ejgsf]nflu @=&) ld6/sf]Goğtd l; lnEsf] prf0{xg' kg5 .

\$= af6f\$]dwo /yfdfly ejgsf]lkn6ysf]prf0{)-\$% ld6/sf]xg' kg5 . t/ lgdff:yn ; 8s eGbf xflf]jf prf0df eP 9n lgsf; ; hf? ?kn]; #fng xg]lsl; dn]ejgsf]lkn6y agfpg' kg5 . ejgsf]tNnf u0fgf ubf{lkn6yb}v dflysf]efusf]dfq ul/g5, lkn6y eGbf tnsf]efu gk/df To; nfo{hdlg tNnf dflgg5 . t/ bff afBfsf ejgx?; u Ps?ktfdf km/s cfpj]u/L lgdff ug{ ; jls[t lb0g]5g .

%= ejgsf]Goğtd rff0{@=\$) ld6/ xg' kg5 . t/ nDaf0{/ rff0\$]cgkft #=! eGbf a9L xg' x5g . olb rff0\$]cgkftdf nDaf0{# u0ff a9L ePdf %) ld= ld=sl]lgdff hfBf0{/fvkgk]xG5 . o; df l:y/ (fixed) Efnfn tyf e]6nZgsf]efux? ; dfj z ul/g]5g .

^= ejgsf]kto\$ sf7fx?df 5fl8Psf]Eofn 9f\$ tyf e]6nZgsf]efu Goğtd ; f]sf7fsf]e0f] 9flsPsf]lfgkmm]Goğtd !% kltzt jf Goğtd lfgkmm)# ju{ld6/ xg' kg5 . o; df l:y/ eofn tyf e]6nZgsf]efux? ; dfj z ul/g]5g .

&= af6f\$]s|b|/yfaf6 5f8y' kg]e"efu (ROW) / ! dl6/ ; fJofs 5f8y' kg5 . bffaf6]hfll8g] :yfgsf]xsdf eg] ; 8s lj efuaf6 tflsP jdfllhdsf]yk e"efu af6f]km(; fJofs 5f8y' kg5 .

*= ejgsf]bff afBftkm(Efnfn 9f\$ g/flvsg Kn6 hluufsf]l; dfgf; Dd ej g lgdff ug{kf0g5 .

(= ejgsf]k5fl8 tkm(Kn6 hluufsf]l; dfgfaf6 !=%) ld6/ hluuf 5f8y' kg5 .

!)= Kn6 hluufsf]l; dfgfaf6 Goğtd !=% ld6/ hluuf 5f8L dfq ej gdf Eofn, 9f\$ tyf e]6nZg /Vg kf0g5 .

!!= ejgsf] hldg tNnf kfls[esf] nflu kofu ug{ ; lsg\$ / o; sf] kj z -ofdk af/ ejgsf] lelqefuaf6 jf kl5lnt/af6 xg'kg\$.

-0_ cfBflus pklf\$ -Industrial Sub-zone_ M

gu/ l; dfgf leq clws dfqdf cfBflus kliti7fgx? /x\$] lqnf0{cfBflus pklf\$ egl tfl]sPsf]5 . o; lqdf lqdf(xg]cfBflus ejg cflbsf]dfkb08 lgDg cg; f/ tfl]sPsf] M

o; lqdf lqdf(xg]ejgsf]lqkm tyf prf0 lgDg adfl]hd xg'kg\$.

!= kn6 hlufsf]\$) kl]tzt e"efudf se/h u/l ejg lqdf ug{kf0g\$.

@= kof/flk6; \kvfh ; lxt ejgsf]prf0{(ld6/ ebf a9l lqdf ug{kf0g]5\$. t/ e-ofE 5fl]g]efu, kfgl 6\$] tyf :nfl]kE 5fgf ; lxtsf]nflu yk @=\$) ld6/ prf0{lqdf ug{kf0g\$. lqdf(xg]ejgsf]; Dk0f{ :6sr/n l8hf0g k\$ ug{k\$.

#= 5fgf; Dd hfg]e-ofE 5fl]kg]efu afx\$ hDdf # tNnf; Ddsf]ejg lqdf ug{kf0g\$.

\$= sf]fsf]Gogtd prf0{@& ld6/ xg'kg\$.

%= af6f\$]dwo /yfb]v snfkq]; 8sdf)=\$) ld6/, ufj h ; 8sdf)=^ le6/, slRr ; 8sdf)=&% ld6/ prf0df ejgsf]lkn\$y agfpg ; lsg\$. lqdf :yn ; 8s ebf xfl]j f prf0df eP 9n lgsf; ; hf? ?kn] ; #fng xg]lsl; dn]ejgsf]lkn\$y agfpg'kg\$.

^= ejgsf]Gogtd rf0f{@=\$) ld6/ xg'kg\$. t/ ejgsf]nDj f0{/ rf0sf]cgkft % M ebf a9l xg'x\$. olb rf0sf]cgkftdf nDaf0 % uoff a9l ePdf %) ld=ld sf]lqdf hf0f{/Vg'kg\$.

&= ejgsf]k]o\$ sf]fx?df /flvg]vNnf Eofn, 9f\$ tyf e]6nzgsf]efu ; f]sf]fsf]e0e]9flsPsf]lqkmsf] Gogtd lqkm)# j u{ld6/ xg'kg\$. o; df l:y/ Efmfn tyf e]6nzgsf]efux? ; dfj z ul/g]5\$.

*= ejg alrsf]6k clwstd)=^ ld6/ tyf 5fgfsf]nflu clwstd)=(ld6/ ; Ddsf]xg'kg\$.

(= cfj f; lo kof]ngsf]ejg lqdf ug{af6f\$]s]b|/yaf6 5f\$y'kg]eèfu (ROW) / ! ld6/ ; jofs 5f8y'kg\$. bf]af6]hf]8g]:yfgsf]xsdf ; 8s lj efuaf6 tfl]sPsf]dfkb08 nfu"xg\$.

!)= cfj f; lo ejgsf]bfof+aføtkm(eofn 9f\$ g/flvsg kn6 hlufsf]l; dfgf; Dd ejgsf]lqdf ug{kf0g\$. t/ c6o ejgsf nflu kn6 hlufsf]l; dfgaf6 #=\$) ld6/ hluf 5f8y'kg\$ / cfj f; lo ejgsf]k5f18 tkm hlufsf]l; dfgaf6 !=%) ld6/ hluf 5f8y'kg\$. t/ ; :yfut ejg, ; ef ejg, xn, cfBflus , Aofkl/s ejgsf]k5f18tkm(kn6 hlufsf]l; dfgaf6 Gogtd #=\$) ld6/ hluf 5f8y'kg\$.

!!= kn6 hlufsf]l; dfgaf6 Gogtd !=% ld6/ hluf 5f8l dfq ejgdf Eofn, 9f\$ tyf e]6nzg /fvg kfgp\$. t/ ; :yfut ejg, ; ef ejg, xn, cfBflus, Aofkl/s ejg cflbsf] xsdf kn6 hlufsf] l; dfgaf6 Gogtd #=\$) ld6/ hluf 5f8y'kg\$. k]o\$ ejgsf nflu ; jAofs 5\$5\$}xg'kg\$.

!@= ; :yfut ejg, ; ef ejg, xn, cfBflus, Aofkl/s ejgx?sf]nflu ; jf/l kfls[esf]lgldQ kn6 hlufdf Gogtd lqkm @) kl]tzt hluf 5f8y'kg\$.

-0_ lj zlf ofhgfut pklfq M (Special Planning Zone)

:yfglo lgsfoj f6 lj zlf ofhgf jgf0{lgdg cg' f/ Joj|:yt eflts k' fvf/ lj sf; ul/g] eefunf0{lj zlf ofhgfut pklfq elg tflsPsf5 .

-!_ gu/ s|b| M o; gkf= cgtut kgij xvfj hf/ j /lk/lsf] sxl eefunf0{gu/s|b| elg tflsPsf5 . o; gu/s|b|sf] eefudf :yfglo lgsfoj f6 cfoyf ofhgfsf] Joj :yf geP; Dd ; flj s j dflhdsf] 3/ ddt ug{ c:yfol 6x/f kvfh cflb lgdfef ug{cgdtl lbg ; lsg5 .

@_ lj ifz cfjf; lo lj sf; s|b| M o; cgtut sd]f/f/sf] sxl eefunf0{lj ifz cfjf; lo lj sf; s|b| tflsPsf5 . o; s|b|cfjf; lo pklfqsf]dfkb08 nfu" xg5 .

#_ Pslst cfjf; lj sf; s|b| M o; cgtut l; l66f/, sd]f/f/ / dgf]f/ krf6sf] sxl eefudf xfn Pslst cfjf; lj sf; cf ofhgf ; fng e)/xsf] eefunf0{Plsst cfjf; s|b| elg tflsPsf5 . o; s|b|cfjf; lo pklfqsf]dfkb08 nfu" xg5 .

-\$_ ko6s kjz tyf j hf/ s|b| M o; cgtut zvw/ rf]j f6 p0/ tkmf] sxl eefunf0{ko6s kjz tyf j hf/ s|b|sf] ?kdf tflsPsf5 . o; s|b|df lgdfef xg] ejgsf] j flx/L cfj /0f k/Dk/fut gj f/L zhl blvg] ul/ ejg lgdfef ug{:j s[t lbg ; lsg5 .

-3_ ; /lft lfq (Reserved Zone) M

o; gu/kflnsfsf] l; dfgleqsf] tNnf] tl6o v]lof]o eefunf0{; /lft lfq elg tflsPsf5 . o; lqdf ejg lgdfef ug\$ nflu lgdfef :yndf lgdg eflts k' fvf/ e); s]sf] cj :yfdf dfq :yfol ejg lgdfefsf] nflu cfjf; lo pklfqsf]dfkb08 nfu" xg] u/L ejg lgdfef ug{:j s[t lbg ; lsg5 .

-a_ xl/t lfq M (Green Zone)

o; gu/ ; ldsf] gbl lsgf/ / jgsf] eefunf0{xl/t lfq tfls lgdg cg' f/ pklfqdf lj efg ul/Psf5 .

-!_ gbl lsgf/ pklfq M ejg lgdfef ug{hf]vd kof{gbl lsgf/ v]lof]o eefunf0{gbl lsgf/ pklfq elg tflsPsf5 . gu/kflnsf lfq leqsf] gbl axf] sf] lsgf/f blv @) ld6/ ; Ddsf] gbl lsgf/ - xl/t kfl _ leq sg}klg lsl; dsf] ejg lgdfef ug{kf0g] 5g . gblaf6 vt/f ptkGg xg] ePdf gu/kflnsfsf] :jLst ln0{afw lgdfef ug{; lsg5 .

@_ jg pklfq M lgnj/f/xl hunnf0{hun kfs{s} ?kdf Joj|:yt lj sf; ug] eefunf0{jg pklfq elg tflsPsf5 . gu/kflnsfsf] :jLst j] / jg pklfqdf sg}klg lsl; dsf] ejg tyf ; Argfx? lgdfef ug{ kf0g] 5g . t/ v]hsb; # ; DalGwt jf cfd hgtfsf] ; lj wfsf] nflu / kfs{Joj :yfsf] nflu cfj Zos ; Argfx? lgdfef ug{kg] ePdf % ld6/ prf0{; Ddsf]; Argfx? lgdfef ug{:j fls[t lbg ; lsg5 .

; fj hlgsg lgdfef ; DaGwl Joj :yf M

-s_ ; fj hlgsg lgdfefsf] ; Argf M gu/kflnsf]f/lgw]t lj zlf ofhgf afx\$; fj hlgsg kfs{tyf eefudf hldgsf] ; txaf6 clwstd \$=) ld6/ prf0{ Ddsf] cfd hgtfsf] ?rl ePsf] kltdf, v]hsb :yfg jf cfd hgtfsf] ; lj wfsf] c6o ; Argf lgdfef ug{:jLst lbg ; lsg5 .

-v_ ; Argfsf]se/h M

; fj hlgS kfs{tyf vNnf e"efu -olb Water Body eP ; f]afx\$ _ df sg}klg ; fj hlgS ; Argfsf] lgdf@f lgDg cg; f/sf]e"efudf dfq xg' kg\$.

- !_ !%) j u{d6/ ; Ddsf]; fgf]; fj hlgS kfs{jf vNnf efudf sh efusf]!) kl|tzt; Dd .
- @_ !%) b]v &))) j u{ld6/; Ddsf] dWod ; fj hlgS kfs{jf vNnf e"efudf sh efusf] % kl|tzt; Dd .
- #_ &))) j u{d6/ eGb 7hf]; fj hlgS kfs{jf vNnf efudf sh efusf]# kl|tzt; Dd .

-u_ eldut ; Argf M

; a}lsl; dsf]; fj hlgS kfs{tyf vNnf e"efudf j ftfj /Ofdf kl|tsh c; / gkfg]u/L ; j {fwf/Ofsf]; lj wfsf] nflu eldut ; Argf lgdf@f ug{; lsg\$.

; Argf]ds l8hf0g / e\$Dk kl|t/f]w lfdtf M ej gsf]hdlg, hu sf7 , 9Ee , cf/= ; l=; l= / kl-P; -kl= - pre-stressed concrete _ , /rgf]ds tyf tof/L (**Prefabricated** _ ; fdu|x?sf] /rgf]ds l8hf0gsf] e\$Dk kl|t/f]w lfdtf /fli6@ ej g lgdf@f ; lxtf adf]hd xg' kg\$.

ej gsf]cfsf/ M lgdf@f ul/g]ej gsf]nDj f0{jf prf0{To; sf]; f#f]efusf]rf8f0 eGb tlG u0ffn]a9L xg] 5g .

9n lgsf; M zff]nosf]kfgl tyf knf]xf] kfglsf]nflu 5\$5\$}lgsf; u/L zff]fnoaf6 cfpG]knf]xf]nf0{;]6L 6df]s / afy?d tyf ef65faf6 cfpG]kfgl jf ;]6L 6df]s dfly af6 cfPsf]kfglnf0{; f\$kl6df v; fNg' kg\$. ; fj hlgS 9n pknAw ePsf]:yfgdf eg]:yfglo lgsfosf]k] {;j ls[t]n]To:tf]kfglnf0{9ndf v; fNg' kg\$.

l; df kvfh M ; ldf kvfh tyf o; sf]hu cf^g};j fldTj sf]hlufdf lgdf@f xg' kg\$. ; fj hlgS tyf af6f] tkm]sf]; ldf kvfh]prf0{!=^} dl6/ eGb clnf]lgdf@f ug{kf0g]5g . ; f]eGb dfly)=^} dl6/ clnf]yk vNnf lsl; dsf]af/ lgdf@f ug{; lsg\$.

9n lgsf; M zff]fno kfgl tyf knf]x/ kfgl -l; Gsafy, af; j]; g; ; fj /, jfy?d, e0[alG] sf]nflu 5\$5\$} lgsf; u/L jfy?d, ef6; f / zff]fnoaf6 cfpG]kfglsf]kf0k lg/Ll0f dufn eP/ :yfglo lgsfosf]k] {;j ls[t ln0{; fj hlgS 9ndf v; fNg' kg\$.

; ldf kvfh M ; ldf kvfh tyf ej gsf]hu cfkmG};j fldTj sf]hlufdf lgdf@f xg' kg\$ / ; fj hlgS hluf tyf af6f]tkm](!=^} ld6/ eGb prf0\$]kvfh lgdf@f ug{kf0g]5g . ; f]dflyaf6)=^} ld6/ clnf]yk vNnf lsl; dsf]af/ lgdf@f ug{eg]; lsg\$.

; 8s -af6f]_ ; Da6wL Joj :yf

gu/ lf@leqs f ; 8s -af6f] x? M gu/lf@sf]lj Bdfg / lj :tf/ xg]af6f]sf]cj :yfnf0{cfwf/dfgl gu/ lf@ leq ePsf / aGg]; 8s -af6f] x?sf]jul\$ /Of lgDg cg; f/ jf6f]k]tfj ul/Psf\$.

æSÆ M dgf]x/f kh -nf]lSnyL_ b]v xgbGt]kh; Ddsf]c/lgsf]/fhdfu@f s]b|/yfb]v bj]km]@% ld6/; Dd :yf0{vfnsf]lgdf@f sfo{ug{lB0g]5g .

ævÆ M dgf]x/f khb]v afxfvf ahf/ xB]lgsf]]f v:ofE v; E vf]hfsf]kh; Ddsf]-l; gfdun gu/sf\$ _ k/fgf] af6f]; 8s v08df s]b|/yfb]v bj]km](!) ld6/; Dd :yf0{vfnsf]lgdf@f sfo{ug{lB0g]5g .

æuÆ M b}fosf ; 8sdf s[b|/vfb]v bj }km(%= Id6/; Dd :yf0{vfnsf]lgdf}f sfo{ug{glbg}.

!_ lfo/f]u c:ktfnsf]klZrdkl\$ c/lgsf]/fhdfu{-; Gb/ gu/ rf\$af6 afnsf} hfg]xgdGt]vf]hfsf]kh; Ddf .
 @_ c/lgsf]/fhdfu{u}f3/ rf\$af6 ; fgf]l7dl SofDk; k'/fgf]af6f] Dd hf}g] -sf]hfg] ; 8s_ .
 #_ c/lgsf]/fhdfu{-lfo/f]u c:ktfnsf]klZrdkl\$ af6 lj i0fs08n l; l4sfnl rf\$ x}k'/fgf]af6f] Dd .
 \$ _ xgdGt]vf]hfb]v c/lgsf]/fhdfu{akkf, hnv' , kf} , kf6l laxf/ x}xhfs rf\$ afxfvf ahf/ k'/fgf] af6f] Dd .
 %_ c/lgsf]/fhdfu{k} {-kzklt l:klgE ldn; sf]pQ/tkm{ af6 akkf u} ; Dd .
 ^_ ehf}h,hnv' nfj f8fh,sd}f}f/ , /fhshf]xb}xgdGt]kh; Dd .
 &_ xgdGt]vf]hfb]v c/lgsf]/fudfu{ /fhshf]; udsf]hfg] x}k'/fgf]af6f]nf]uf]sf/vfgf; Dd .
 *_ ; fgf]l7dl -P; =cf}P; = _ af6 vknf ldn/f} rf\$; Dd .
 (_ vknf blv dh ; 8s; Dd hf}g]j f6f].
 !)_ !@ g+sf]; fg}f/ rf\$ blv af}hfg]dh af6f] Dd .
 !!_ afxfvf ahf/ led; g :yfgblv af}]; fg}f/ rf\$; Dd .
 !@_ g+sf]pQ/ tkmf]af6f]v l; G6l6f/; Dd hf}g]j f6f].
 !#_ af}]; fg}f/ rf\$blv bj fsf} uf=lj =; = l; dfgf; Dd .
 !\$_ k'/fgf]af6f]kbd 008li6k /fhshf]xb}l; lG66f/ k} kl\$; 8s; Dd .
 !%_ lxdfno kf=l= lgsf] }faf6 l; G6l6f/ k} kl\$; 8s; Dd .
 !^_ af}]; fg}f/ rf\$af6 l6ugl x}bj fsf} uf=lj =; = l; dfgf; Dd .
 !&_ af}]; fg}f/ rf\$af6 dhkfgl uf=lj =; = hf}g]dgf}/f kh; Dd .
 !*_ gub}z w}rf]f}j f6 dgf}/f uf}f6f/; Dd .
 !(_ j xfvf j hf/ k'/fgf]af6f]xhfs /f}af6 g+sf= ej g x}ldn/f}; Dd hf}g].
 @)_ ldn/f} sfdl6f}haf6 lyldnf af6f]af}]/E/f}; Dd hf}g].

æ3Æ M s[b\$]; 8sdf s[b|/vfb]v bj }km(\$ Id6/; Dd :yf0{vfnsf]lgdf}f sfo{ug{lbo}g}5g} M

!_ c/lgsf]/fhdfu{sf}zn6f/rf\$}j f6 j fnsf} hfg]kh; Dd .
 @_ nf}l}Nynl j ; :6k klZrd c/lgsf]oftfoft clk; pQ/ klt{hlufj f6 pQ/ w} wf/f, vl/sf] j f6f]j \$0ufp}f]wf/f, gf6dfZj /L ; fgf]l7dl ; Dd hf}g]j f6f].
 #_ nfaf8}naf6 l; j f6fh; Dd .
 \$ _ c/lgsf]/fhdfu{-Sof}6k} u} 5}psf]k} kl\$ blv xgdGt]vf]hf; Ddf .
 %_ \$ g+df pNn}vt af6f}f]b/l}sf]s/lj larlt/af6 xgdGt]vf]hf; Dd .
 ^_ c/lgsf]/fhdfu}af6 af06/ 008li6k x}blif0ftkm{xgdGt]vf]hf; Dd .
 &_ dWok/ u}6 xfp; j f6 s08fh x} /fhshf]hf}g]j f6f].
 *_ sf]hfg] ; 8saf6 xj f0{l}j efu pQ/ l; dfgf / Jof/\$ x}k'/fgf]af6f] Dd .
 (_ c/lgsf]/fhdfu{-lfo/f]u c:ktfnsf]k} kl\$ af6 t56fh; Dd .
 !)_ c/lgsf]/fhdfu{ld On\$6}g\$; af6 k} {x} /fhshf] Dd .
 !!_ ufrf{af/k}v -gub}zj f6_ ldn/f}; Dd .
 !@_ l}tgwf/faf6 Gx"lx6l gub}z; Ddf .
 !#_ gub}z Wj fsf]; af6 w}rf]kfvf; Dd .
 !\$_ gub}z Tj fluf l; r6fh}blv l/E/f} sdnkfy/L x}k}rf]Wj fsf; Dd .
 !%_ ; fg}f/ blif0f ; 8sblv k} {x} /fhshf] Dd .
 !^_ l6sglaf6 lgnaf/fxl h}n l; dfgf; Dd .
 !&_ c/lgsf]/fhdfu{dgf}/f kh vfg}kfgl of]hg} x}j 9fyf\$}L ufp}Ddsf]j f6f].
 !*_ w} sfs}l\$}3/j f6 ; fw/fd v8\$fsf]3/xb}lgsf}z}f hfg]j f6f].
 !(_ hnfv' hfg]j f6f] f6 k} {x} ehfv}h j f6 sd}f}f/ hfg]j f6f]hf}g].
 @)_ j f}]; fg}f/ blv b}j 6fh; Dd .

@!_ ufv' k#sGof dlG6/ b|lv l8n xb}lgsfz}fsf]vx/] Dd .
@@_ sfzn6f/ szne}j dlG6/af6 lbks cfrfo\$]3/; Dd .

æ^aÆ M b}fosf]xsdf s|b|/yfb|v bj }km(# ld6/; Dd :yf0{vfnsf]lgdf0f sfo{ug{lb0g]5g .

!_ dh ; 8sj f6 vknf hfg]byhf; Dd .
@_ sfzn6f/ a; :6ksf]5paf6 klZrd xb}sfzn6f/ s66fj ; Dd .
#_ sfzn6f/ dh ; 8saf6 ; fuaf/L ls; fgdfu{af6f}xb}u}f3/ a; :6k; Dd .
\$_ hof j fl8E :shj f6 ldn/f8 hf8g]j f6f].
%_ c/lgsf]/fhdfu{sfzn6f/ wfllj wf/faf6 8km; Dd .
^_ ^a j u\$]#& g=sf]; 8saf6 l6-cf046-cf0€ xb}u}f3/ sfhfql ; 8s; Dd hf8g].
&_ ^a j u\$]#& g=sf]; 8saf6 dflj pNn|vt ^ g=sf]; 8s; Dd hf8g].
*_ ^ g=df pNn|vt ; 8saf6 ; fgf]l7dl k/fgf]af6f] Dd hf8g].
(_ u}f3/ sfhfql ; 8saf6 lj i0fs08n lg/sf]; 8s; Dd .
!)_ u}f3/ sfhfql ; 8saf6 lqej g cGt/fli60 lj dfg:ynsf] bli0f l; dfgf xb}u j u\$] \$ g=sf] ; 8s; Dd hf8g].
!!_ lqej g cGt/fli60 lj dfg:ynsf] bli0fk} {l; dfgfaf6 k} kl\$ l; dfgf xb}pQ/-k} {l; dfgf; Dd .
!@_ ; fgf]l7dl Aof/\$sf]l; dfgf xb}sfhfql lj i0fs08n hfg]; 8s; Dd hf8g].
!#_ u}f3/ xj f0{lj efusf]k} {alr -l; dfgfaf6 !# g_+sf]; 8s; Dd hf8g].
!\$_ j Kkf dxfb] :ygfaf6 afnsdf/L psfnf]hfg]af6f] Ddf .
!%_ j Kkf u6af6 nfj f8fj ; 8s; Dd .
!^_ nfj f8fj ; 8saf6 hnv' sd}f6f/ hfg]; 8s; Dd .
!&_ lxd On\$6llgS; 5psf]af6f6 /fhshf\$]af6f] Dd hf8g].
!*_ k/fgf]af6f6 hnv' /fhshf]; 8s; Dd hf8g].
!(_ !* g=sf]af6f6 hnv' /fhshf]; 8s; Dd hf8g].
@)_ ; fgf]l7dl SofDk; sf]pQ/tkm(du/ ufp+ /E/f8 j f6f l/E/f8 hf8g]; 8s; Dd .
@!_ lhlnf j g sfofho ; fgf]7dlsf]pQ/tkm6f6 af; j f/L xb}du/ ufp+Dd .
@@_ ; fgf]7dl-vknf hf8g]; 8s; Ddf .
@#_ gubz efl; +x6lb}l dfvj; Ddf .
@\$_ gubz Wj fsfl; +6fjaf6 dfvj dgl xb}sfy af6f] Dd hf8g].
@%_ g-kf= ej gsf]5pb|v k} tkm(led; g rnlrq ej g xb}k/fgf]af6f]kx/L rf\$; Dd .
@^_ l; G6L6f/ bli0f ; 8s cufi8sf]; 8s -!!ld6/ / * ld6/ ; 8s hf8g]; 8s_ .
@&_ rqmky sdnkfy/L ; 8sj f6 j 8f g+! Vof}f hf8g]; 8s; Dd .
@*_ j fldtl cfon :6f]sf]k} {tkm\$]j f6f]xb}sd}f6f/; Ddsf]; 8s .
@(_ efvjh hfg]j f6f] f6 k} {xb}rnfFf eGg] f6f]t; f}fdf hf8g].
#)_ k/fgf]af6f]xsd kmdf; l6sN; bli0faf6 sd}f6f/sf]dhj f6f] Dd .
#!_ c/lgsf]/fhdfu{nf}lslNynlaf6 a9fyf\$ l ufp+xb}l6sfynl hfg]xgdGt]vfjhsf]kh; Dd .
#@_ e\$ /f0{6fj Jof/\$ u6sf]pQ/k} 6f6 du/ ufp+ /E/f8; Dd .
##_ dh ; 8sj f6 vknf hfg]byhf; Dd .
#\$_ zvw/ ; fvj f rf\$af6 xgdGt]vfjhsf]kh; Dd .
#%_ sfzn6f/ rf\$af6 hftlufn sdnkfy/L xb}; fgf]l7dl k/fgf]af6f] Dd hf8g].
#^_ c/lgsf]/fhdfu{oÿ uf8}sf]k} {t/j f6 0\$8fj hfg]j f6f].
#&_ c/lgsf]/fhdfu{nf}lslNynlj f6 ; fgf]7dl hfg]dh ; 8s .

æ^rÆ M b}fosf]xsdf s|b|/yfb|v bj }km(@ ld6/; Dd :yf0{vfnsf]lgdf0f sfo{ug{lb0g]5g M-

!= sdn o}f kl/j f/j f6 klZrd 3 j u\$]@ g+j f6df hf8g].
@= nf\$}j / dxfb] :ygsf]klZrdsf]rf]f6f] f6 klZrd 3 j u\$]@ g+j f6df hf8g].

#= nf\$Zj / dxfb] :yfgj f6 k] {pQ/sf] f6f].
 \$= xlykfij6j f6 klZrd 3 j u\$]@ g+j f6f]f hf\$g].
 %= xlykfij6j f6 k] \$f]00b\$dnsf]j f6f]f hf\$g].
 ^= ldlngod :shsf]pQ/ rf\$] f6 klZrd 3 j u\$]@ g+df hf\$g]j f6f].
 &= lzjgu/ rf\$] f6 klZrdsf]j f6f].
 *= ldlngod :shsf]pQ/ rf\$] f6 j \$ufpffg]j f6f].
 (= nfXlsNynl j ; :6kj f6 k] {c/lgsf]/fhdfu} f6 blifof uofz :yfg dlGb/ blv blifofsf]rf] f6f]f hf\$g]j f6f].
 != j 9fyf\$ l ufpff]cf]fnf] f6 klZrd vl/sf]?v; Ddsf]j f6f].
 !!= nfXlsNynl j ; :6kj f6 k] {rf] f6f] f6 blifofcf]fnf]u}g; {l e}hfg]j f6f].
 !@= ; fls\$]kfvf] f6 pQ/ bxfnsf]3/ xb)!& j 8f hf\$g]j f6f].
 !#= ; fls\$]kfvf] f6 pQ/ klZrd bxfnsf]3/ cuf8lsf]rf\$] f6 blifof / klZrd tkn\$]j f6f].
 !\$= uofz:yfg blv blifof rf] f6f] f6f] f6 klZrd 3 j u\$]!& g+sf]j f6f] u hf\$g].
 !%= OGb|sdn wf/f 6rf6f/blv 6rf6f/; Ddf .
 !^= Zofd s[0f kf\$ n / k|bk zdf\$]3/sf]lj rj f6 hfg]j f6f].

gfb M-s_ ju{asAb|v a^aE ; Dd pNn|vt af6f?afx\$ gu/ lfg leqsf @=\$) ld6/blv \$=) ld6/; Dd rf\$fo{
 ePsf cGo af6f?nf0{df6/af6f]dfgl o:tf af6f?sf]rf\$fo{@ ±@ Ö \$ ld6/ sfod ul/Psf]5 .
 \$=) ld6/ eGbf a9L rf\$fo{ePsf]pk/fQm ju{?df gk/\$] af6f] ePdf sfod /x\$] rf\$fo\$
 cfwf/df pQm ju{df ; dfj z eP ; /x dflgg\$.

-v_ o; ljlgoddf pNn|v gePsf gu/ lj sf; ; ldl tj f6 k|tflj t tyf lj :tfl/t j f6f]gu/ lj sf;
 ; ldl tj f6 tf\$]j df]hd sfod ul/g\$.

kl/R5p \$

eQmk/ gu/kflnsf Ifq leq ul/gllgdf0f ; DaGwl dfkb08

kl/R5b \$

- o; kl/R5bdf g; d]6Psf lj ifox?df kl/R5b ! sf]; fdfGo Joj :yfdf p]Nnlvt klj wfg nfu"xbg\$ _

eQmk/ gu/sf]k/Dk/fut g]f/L jf:t'snf, ; fFs[ts ; Dkbf / df]ns zx/L :j?knf0{; Af0f, ; Dj 4G / ; Joj l:yt ug]tyf ef]ts k]f]v/x? ; d] lj sf; ub]j R5 ; kmf j ftfj /0f sfod ug] / P]txfl; s gu/nf0{hlj Gt /Vg] a9bf]zx/ls/0f / ef]ts lj sf; nf0{; d] of]hgj 4 tl/sfn]Joj l:yt ub]hfgsf nflu gu/kl]nsf lf]leqsf] e"efunf0{e"pkof]usf]gSzdf b]fP adf]hd lgDg cg; f/ lf]ut lj efhg ul/Psf] / lgdf0f ; DaGwl dfkb08 ; d] tf]sPsf]5 .

!= k/Dk/fut ; fFs[ts cfj f; lo lf]@=lj sf; zln lf]#= xl/t lf]

!= k/Dk/fut ; fFs[ts cfj f; lo lf] M

P]txfl; s / ; fFs[ts k[7eld af]sf] / k/Dk/fut g]f/L jf:t'snf / lj leGg ; #s[tn]el/k0f{3gf a:tl]nf0{k/Dk/fut ; fFs[ts cfj f; lo lf] egl tf]sPsf] 5 . k/ftf]j s, ; fFs[ts / jf:t'snf]ds b[6sf]fn]o; lf]nf0{lgDg pkl]df lj efhg ul/Psf]5-
-s_ ; Af]t :df/s pkl]
-v_ ; fFs[ts ; Dkbf pkl]
-u_ ; lGgs6 pkl]

-s_ ; Af]t :df/s pkl] M

o; pkl] leq k/ftf]j s, P]txfl; s dxTj sf b/j f/, dlGb/, axfn, j xl cflb k/]x]f o; lf]sf] P]txfl; s, ; fFs[ts Pj +j f:t'snf]ds j ftfj /0fdf kl]tsh c; / gkf/L k/Dk/fut jf:t'snfsf]; Af0f xg] u/L lgdf0f / ; wf/ ug{:jls[t lbG ; lsg] 5 . o; lf]sf]k/Dk/fut ejgsf]; Af0f Joj :yf / lgdf0f ; DaGwl dfkb08 lgDg adf]hd xbg\$ M

!= o; pkl]df d]Nnsfnlg, zfxsfnlG / /0ffsfnlG jf:t'snfsf]zx/L :j?k; # j ftfj]sInt xg]u/L kgM lgdf0f, dd] ; wf/ / gof]lgdf0f ug]{lb0g\$. k/Dk/fut 3/x?nf0{ltglx?sf]df]ns :j?kd} sfod /Vg kl]; flxt ul/g\$. :jls[tsf nflu k] xg cfpG]gSzdf z]lut ?kdf cfj Zos b]vPdf :yflo lgsfon]cfj Zos ; z]vG ; d] u/fpg ; Sg\$.

@= o; pkl]df ejgsf]dd], kgM lgdf0f / gof]lgdf0f ug]{k] xg cfpG]gSzdf k/ft]j lj efusf] k] { :jls[t / l; kmf/; cfj Zos kb\$. k/ft]j lj efuaf6 l; kmf/; e0{ cfPsf] gSzdf gu/kl]nsfn]cGo gSzf ; /x cfj Zos hfFaem ug{: Sg\$ / lj efunf0{hfgsf/L lbP/ kl]rlG :df/s ; Af0f P] / ; f]f6 lgb]zt lgdf0f ; DaGwl dfkb08leq /x] cfj Zos ; z]vG ; d] ug{ u/fpg ; Sg\$.

#= ; flj s ejgnf0{v08ls/0f ubf{lj z]f snf]ds %ofn, 9f]fx? 0Toflb ; flj s adf]hd /Vg kg\$. sG]klg efusf]df]x8f @=\$ ld6/ e]bf sd xg'x]G\$.

- \$= ; flj s 3/ dd{ ug{ jf kgM lgdf@f ubf{ sfi7snfsf pTs[6 ; Argfx? h:t}l6sl %ofn, ; %ofM 9f\$sf, yfd cflb / 6/ fsf0fx? ; d{ ; fdf6o ; /; knf0{/ dd{af6 kgMk0f} ug{ ; lsg] b]vPdf To: tf j :tx? kgk0f} ug{u/L :j lS[t lbg ; lsg\$.
- %= dfl]ns jf:t\$nf cg?ksf] ej gx?sf] lgdf@f nf0{ kfl] ; flxt ug\$sf] nflu 3/ lgdf@f ubf{ k0fg ug{ ; lj wf / ; xlnot :yfglo lgsfon] lgwf{0f ug{ ; Sg\$. snfids j :tx?sf] dd{ ; ef/df :yfglo lgsfon] cfj Zos kflj lws / cfly\$; xof} ; d{ k0fg ug{ ; Sg\$.
- ^= lSOf gflkl gSzfdf b]v0Psf] / xfn e}fv\$] ; fj h]gs tyf lghl rf\$nf0{oyj t sfod /Vg' kg\$. ; flj s rf\$sf] ; Af0f / ; Dj 4g ug{ sfo{ rf\$ pkefustf\$] xg\$ / rf\$df c6o sg' k\$ /sf] lgdf@f sfo{ug{kf0g]5g . rf\$dfly ; flj s ePsf]afx\$ Sof66ln} /, sf]f, afb0l lgsfNg kf0g]5g . rf\$sf]k0lnf0{rf\$}lx: ; f dflgg\$.
- &= k/ftflj s / ; fS[ts dxTj sf ; Dkbf h:t}kf6L, kf}f, ; tn, dl6b/, r]o, jxf, Bf\$} 9u]v/f, kfy/L cflbnf0{k]tsh c; / gkg]u/L dfq lgdf@f ug{cgdlt lb0g\$. jf:t\$nfut ?kn]lj z]f dxTj af\$}sf k/fgf 3/x/nf0{ ; ej eP; Dd dd{sf]nflu dfq cgdlt lbg ; lsg\$. k/ftflj s / ; f:s[ts b]6n]lj z]f dxTj af\$}sf lghl :j fldTj sf 3/x? ; dodf plrt ; ef/ ge0{jf c6o sf/0faf6 dfl; g nfu\$}f]7x/ ePdf :yfglo lgsfon]lgodfg' / ; f]3/x? v/lb jf clwux0f ; d{ ug{ ; Sg\$.
- *= o; pklf0df lgdf@f xg]ejgsf]lf0km tyf prf0{lg0g adfl]hd xg\$ M-

l; =g+	ejgsf]lsl; d	h]ufsf]lf0km	clwstd uf08	clwstd prf0{	clwstd tnf	^nf] xf06
!=	vfnl h]ufdf 3/ lgdf@f ubf{	@ cfgf @ k}f ; Dd	()%			Gogt & kml6 ^
@=	ejg agfpg	@ cfgf @ k}f e6bf a9L	*)% &)& j u{ lkm6 d]l0] hg a9L x65	#% lkm6 - !)=& dl=_	\$	0Gr
#=	; flj s kgMlgdf@f	-	!))%			

- (cfkngf] h]ufdf l5d\$lsf] 3/; # ldNg]u/L)#-)=% ld6/ -!-!-% kml6_ prf0 /)=^ ld6/ -@ lkm6_ ; Ddsf]rf0sf]k0l agfpg kf0g\$. le/fnf]af6f0f k0lsf]prf0{lnbf d]l0 lj G6af6 gflkg] 5 . pk/f0m prf0{/ rf0f0{e6bf a9L ; flj s k0l eP ; f\$] prf0e6bf ga9g]u/L dfq lgdf@f ug{k}x65 .
- !)= gofFejgsf] ; a}tNnf?nf0{eYofax?sf]:nfk a9Ldf \$% l8ul tyf eYofasf]rf0f0 slDtdf)=* ld6/ -@ lkm6 &=% 0Gr_ xg]u/L agfpg' kg\$. 5fgf06bf aflx/ b]vg]u/L !)=& ld6/ -#% lkm6_ prf0e6bf dflj nu} eYofa v08 agfpg / 5flg kf0g]5g .
- !!= o; lf0df j] d06 agfpg]u/L cgdlt lb0g]5g .
- !@= 3/sf] aflx/L efusf] uf/f0f k]6; # b]vg]u/L 06fsf] uf/f] (Brick exposed wall) xg' kg\$. em0fn 9f\$sf lsgf/f, sfg] / jfn lkn/df rgf, ; vL{kf:6/ ug{ ; lsg]5 . uf/f0f ; fdf0tof

l; d06, r0gf cflb /fvl knfi6/ ug{kf0g]50 . t/ /f0ffsfnl0 z0hlsf 3/x?sf]ddt / k0glgdf0fdf
r0gf, ; vLsf]knfi6/ ug{; lsg]5 .

!#=# %ofn 9f\$fx? sf7sf] xgkgI / pQm %ofn 9f\$fsf] rf0f0{ prf0{ dNnsfnlg, zfxsfing /
/f0ffsfing z0hl cg; f/sf]cfsf/ k\$sf/sf]xg' kg5 . a0undf k/Dk/fut %ofnx? /fVg ; lsg]5 .
9f\$fdf vfkfx? sf7sf xgkgI/ kmfd]/f]n^a ; 6/, luh / r00 u0 cflb /fVg kf0g]50 . %ofnx?
lahf] dV] xg' kg5 . e0{ tNnfd Psdv] %ofn dfq /fVg kf0g]5 . c0o lj hf]dvl %ofnsf]
xsf klt sj n)=&% ld6/ -@j ^E_ sf] b/n] 000Qd rf0f0{ sfod ug{ kg5 . nfdrf] %ofn
9f\$fsf]prf0{/ rf0f0sf]cgkft !M-% b]lv !M ; Dd xg' kgI5 . jufsf/ emfnx?)=() ld6/
X)=() ld6/ e0bf 7hf] xg' x00 . ; flj s emfn 9f\$ / ; f]l z0hldf agf0Psf gofFemfn
9f\$fsf]k0flunf0{cfj Zostf cg; f/ k]l; flxt ug{; lsg5 .

!\$=# 3/sf]k]0\$ tNnf 5l6g]u/L a9ldf !%) ld= d= ^ 0GrL ; Dd uf/f\$] ; txebf aflx/ lgsfnl
sf] /fVg ; lsg5 . sf] ; se/ bf0f af0fsf]3/ ; u ldNg]u/L agfpg' kg5 .

!%=# ; 8stkmsf] dfx8fdf cfkmf] hluufly kgI u/L a9ldf)=* ld6/ ; Ddsf] afb0l /fVg] ; lj wf lbg
; lsg]5 . t/ # ld6/e0bf sd rf0f0sf]af0df pk/f0m ; lj wf lb0g]50 . k5f8sf]glh hluftkm
@ ld6/sf] ; 0Aofs /fvl ! ld6/ ; Ddsf] afb0l klxn] tNnfb]lv /fVg ; lsg]5 . ! ld6/e0bf a9l
rf0f0{cfj Zos ePdf ; f]l adf]hd yk ; 0Aofs 5f0g' kg5 .

!^=# cl6td tNnfe0bf dlq dfq)=(ld6/ # lkm_ rf0f0{ Ddsf] an0l kvf rf\$ / af6f] tkm{afx\$
cfkmf] hluufdf kgI u/L lgsfnlg kf0g]5 . af6f] / rf\$tkm{cfkmf] hluuf xgkgI j fllo ul/g]50 .
kvf ; se/ bf0f af0fsf] 3/sf] kvf / an0l ; u ; 6fP/ ldNg]u/L xflg' kgI5 . ejgsf] an0l
kvf, dh 5fgf / e0fa^a 5flg]efu ; d] @% l8ullb]lv #) l8ull; Ddsf] 9Nsf0df agfpg' kg5 .
5fgdf clgj fo{?kdf lem#6L=6fonn]5fpg' kg5 .

rf] tNnfsf] dh 5fgf k/Dk/fut g] f/l z0hlsf] b0{kvf] 5fgf xg' kg5 . t/ lgdf0f xg] ejgsf]
ltg]t/ c?sf] 3/n] 3]sf] ePdf ; 8skl\$ Ps kvf] 5fgf /fVg ; lsg5 . 5fgsf] j gfj 6n] l5d\$lnf0{afwf
kgI lgsf; sf] ; d:of kgI u/L agfpg kf0g]50 . 5fgf / aflx/L efudf kgl 60fsl, l8:s P60f,
Po/sl68zg ; 0, sh/ ; 0, Solar Equipment cflb ; 8s tyf rf\$af6 b]lv]u/L /fVg kf0g]50 . To:tf
cfwlg ; j fx? ; 8s tyf rf\$af6 gb]lv]u/L jf ejgsf] jf:tsnfd kltsh c; / gkgI u/L /fVg
:yfglo lgsfon] lgbzg lbg ; Sg5 . lgodfg; f/ kfp] cl6td tNnf; Dd gagfpg] ePdf cj:yf x]l
k/ft]j lj efu jf g-kf-n] lj z]f lgbzg lbPsf] cj:yfdf afx\$ e0fa^asf] efu le/fnf] 5fgf /fvl c0o efu
sfzlsf]?kdf vNnf /fVg ; lsg5 .

!&=# clwsQd prf0{lgdf0f ugI ePdf cl6td -rf] tNnfd 5fgsf] ## kltzt; Ddsf] sfzl agfpg
; lsg5 . lj z]f kl/l:y]tdf ; DalGwt lj z]f1 ; lxtsf] ; ldtsf]/fo ln0{:yfglo lgsfon] sfzlsf]
lf0kmdf yk36 xg]u/L sfzl /fVg lbg jf glbg klg ; Sg5 .

!*=# ; flj s adf]hd ddt, tNnf yk / kglgdf0fdf afx\$; fdf0tof lgdf0f ugI ej gaf6 kn6df lgDg
cg; f/ ; 0Aofs 5fl8Psf] xg' kb5 . ; 0 Aofs b/l df ROW lgwf]0f ePsf ; 8sx?sf] xsdf
a9ldf)=() ld6/ ; Dd / c0o af0df)=^ ld6/ ; Dd v8tsnf jf k0l /fVg ; lsg]5 . pQm
; 0Aofs b/l df dflyNnf] tNnfd an0l, 5fgf k0fhgsf] nflu afx\$ Sof60ln0f/, sf]f cflb kgI u/L
lgsfnlg kf0g]50 .

!(=# ; flj s adf]hd ddt / kglgdf0fdf afx\$; fdf0tof vnl hluufdf gofF3/ lgdf0f ubf{af6f] km
; 8s dfkb08 lgwf]0f ePsf] 7fp0f ; 8s dfkb08 cg; f/ jf ; 8s dfkb08 lgwf]0f gePsf]
cj:yfdf 000td ! ld6/ cfkmf] hluuf 5f8l lgdf0f ugI kgI5 . t/ k/Dk/fut :j?knf0{sfod /fVg]

b[6sf0fn]lgdf0f :ynsf] b0f af0ftkm{ ; flj s 3/ jf 3/x? ePsf] cj :yfdf bfof+afof+tkm{sf] 3/nf0g ldNg]u/L agfpg :jLs[t lbg ; lsg]5 . Psftkm{dfq}3/x? ePsf]cj :yfdf pk/f0m 3/ nf0gsf] ; lj wf lbg j fwo xg]5g .

@)= ; fdf0tof cfjf; lo ejgsf] b0f af0f / k5f18tkm{ %ofn 9f\$, cf0L %ofn / e[6n}zg g/flvsg kn6 hlufsf]l; dfgf; Dd agfpg ; lsg]5 .

@!= ; flj s 3/sf]ddt tNnf yk / kgldf0fsf]cj :yfdf afx\$ gofFlgdf0f / kgldf0fdf b0f af0f / k5f18tkm{ %ofn 9f\$ tyf e[6n} g /Vg kn6sf]l; dfgfaf6 sldtdf !-% ld6/ 5f8} dfq lgdf0f ug{ kf0g]5 . olb cfjf; lo k0fhgsf] ejgsf] lkn6y Pl/of !%) ju{kml6e6bf a9L xg uPsf] cj :yfdf kn6 l; dfgfaf6 @-% ld6/ 5f8L dfq lgdf0f ug{lb0g]5 . %ofn 9f\$sf]nflu 5f18g]; 0Aofs k]0\$ kn6sf]nflu 5\$5\$}xg' kg]5 . olb Pp6}kn6df klg Pse6bf a9L ejg a6g]ePdf k]0\$ ejgsf]5\$5\$}; 0Aofs sfod /Vg' kg]5 . b0f af0ftkm{!-% ld6/ g5f8g]xf]eg]; lwof/sf]lnlvtd6h/L lj gf %ofn 9f\$ / e[6n}zg /Vg kf0g]5g .

@\$= o; lqdf sg}lsl; dsf]krf{ kf]6/ 6fFg kf0g]5g . cj ; / lj z]fdf /flvg] th, Aofg/ afx\$ Jofkl/s k0fhgsf]nflu /flvg]lj le6g k\$ /sf]lj 1fkg kf6lsf]nflu gu/kflnsf]k} { :jLs[t lng' kg]5 . b}o k0f0f ug] / ; fS[ts / wld\$ b[6sf0fn]cfklQhgs blvPdf To:tf lj 1fkg kf6L t?6t x6fpg nufpg ; lsg]5 .

-v_ ; fS[ts ; Dkbf pklfq M

o; pklfq leq e-pkof]usf]gS; fdf b]f0P adf]hd k/Dk/fut P]txf; s lj sf; qmddf lj sf; x0} cfPsf]k/fgf] z]hlsf zx/ -cj 0 Sof/\$6/_ emsfpg]vfnsf af6f? , rf\$ x? / To; j l/kl/sf af6f] jf rfs; # hf]8Psf lsQdf ag\$ ejgx? / k/Dk/fut z]hlsf 3/ ejgx? / dl6b/x? cflb kb5g\ ol af6f] / rf\$ x?sf] 7f0 7f0df ; fS[ts tyf wld\$:ynx? / k/Dk/fut z]hlsf s}l gkfln 3/x? cem}af6L /x\$ 5g\ t; y{o; lqleqs ol k/fgf cj 0 Sof/\$6/_ emsfpg]j f:tsnf, ; fS[ts tyf wld\$:ynx?sf]; fy}k/Dk/fut z]hlsf jf:tsnf0{; Af0f ; Dj w0df kl]tsh c; / gkg]u/L gofFlgdf0f jf ddt sfo\$]nflu g-kf-n]lgDg adf]hd :jLs[t lbg ; Sg]5 .

! = o; pklfqdf k/Dk/fut df]ns g]f/L jf:tsnfsf]zx/L :j?k; # jftfgsInt xg]u/L kgM lgdf0f, ddt ; wf/ / gofFlgdf0f ug{lb0g]5 . k/Dk/fut 3/x?nf0{ltglx?sf]df]ns :j?kd}sfod /Vg k] ; flxt ul/g]5 . :jLs[tsf nflu k} xg cfp]g]gSzdf z]lut ?kdf cfj Zos blvPdf g=kf= n] ; zfv]g; dt] u/fpg ; Sg]5 .

@ = ; flj s ejgnf0{ :yfglo lgsfosf]k} { :jLs[t lj gf v08ls/0f ug{kf0g]5g . v08ls/0f ubf{l j z]f snf]ds %ofn, 9f\$ x? lj?k xg]u/L sf6g kf0g]5g . v08ls/0f e0{a6g]sg}klg efusf]df}8f @-\$ ld6/e6bf sd ePdf gu/kflnsf :jLs[t lbg j fwo xg]5g .

= ; flj s 3/ ddt ug]j f kgM lgdf0f ubf{olb sfi7snfsf p]s[6 ; Argfx? h:t}l6sl %ofn, ; %of, 9f\$, yfd cflb / 6/f\$0fx? ; dt] ; fdf0 ; / ; kmf0{/ ddt af6 kgM k0f]u ug{ ; lsg]blvPdf To:tf j :tx? kgM k0f]u ug]u/L dfq gSzf :jLs[t lb0g]5 .

\$ = df]ns jf:tsnf cg?ksf]ejgx?sf]lgdf0fnf0{k] ; flxt ug\$]nflu 3/ lgdf0f ubf{k0fg ul/g] ; lj wf / ; xlnot :yfglo lgsfon]lgwf0f ug{ ; Sg]5 . snf]ds j :tx?sf] ddt ; ef/df :yfglo lgsfon]cfj Zos k]lj lws / cfly\$; xof]u ; dt] k0fg ug{ ; Sg]5 .

% = lsQf gkl gSzdf b]f0Psf] / xfn e}fv\$]rf\$nf0{oyfj t sfod /Vg' kg]5 . ; flj s rf\$sf] ; Af0f / ; Dj 4g ug]sfo{rf\$ pkef]ustf\$]xg] / rf\$df c0o sg}k\$ /sf]lgdf0f sfo{ug{

kf0g]5g . ; fy}rf\$dfly ; flj s ePsf]afx\$ Sof6Lnē/, sf]f, afbhl lgsflng kf0g]5g . rf\$sf] kblnf0{rf\$ss}lx:; f dflgg\$.

^= k/ftflj s / ; fEs[ts dx]j sf ; Dkbf h:t}kf6L, kf]f, ; tn, dlGb/, r]o, j xf, Bf\$]9u]w/f, kf]/L cflbnf0{k]tsh c; / gkg]u/L dfq lgdff ug{cgdlt lb0g\$

&= o; pklfqdf ; flj s adf]hd dd\$ / kblgdffdf afx\$ vfnl hlufdf 3/ lgdff ubf{ejgsf] clwsQd uf]p08 se/h lgdg adf]hd xg\$ M

l; =g+	ejgsf] lsl; d	hlufsf]lfqkm	clwstd uf]p08 se/h	clwstd prf0{	clwstd tnf	
!=		@ cfgf @ k}f; Dd	()%	##% lkm6 - !)-& dl=	\$	Goğtd
@=		@ cfgf @ k}f eGbf a9L	*)% &&) j u{ lkm6 d]llo] hg a9L xG5 .	æ	\$	& lkm6 ^ OGr
; flj s kğMgdff		-	!))%	æ	\$	

*= cfkn]hlufdf l5d\$lsf]3/; u ldNg]u/L)=\$% blv)^ ld6/ prf0{/)^ ld6/; Ddsf]rf8f0sf] kbl agfpg' kg\$. le/fnf]af6f] kblsf]prf0{lnbf alraf6 gflkg]5 . pk/fQm prf0{/ rf8f0{ eGbf a9L ; flj s kbl eP ; f\$]prf0{eGbf ga9g]u/L dfq lgdff ug{k]xG5 .

(= gofFejgsf]; a}tlnfx?nf0{e}ofax?sf]:nfk a9ldf \$% l8u] tyf e}ofa}sf]rf8f0 slDtdf)-&% ld6/ xg]u/L agfpg' kg\$. 5fgf]eGbf dfly nu] e}ofa v08 agfpg / 5flg kf0g]5g .

!)= o; lqdf k[s[ts :nfksf] sf/0faf6 n]n l8k] ; sf] xb; Dd ;]dj] d]6 agfpg ; lsg] 5 . j] d]6 agfpg]u/L cgdlt lb0g]5g . Ps tNnf; Ddsf];]dj] d]6nf0{sh prf0{df u0gf ul/g] 5g .

!!= 3/sf] aflx/L efusf] uf/f] k]6; u blvg] u/L 06fsf] uf/f] (Brick exposed wall) xg' kg\$. em]fn 9f\$fsf] lsgf/f, sfg] / jfn lkn/df rgf ; v]sf]knf:6/ ug{; lsg] 5 . uf/f] l; d]6, rgf cflb /vl knfi6/ ug{kf0g]5g . t/ /f0ffsflng z]hlsf 3/x?sf]dd\$ / kblgdffdf ; flj s adf]hd rgf ; v]sf]knfi6/ ug{; lsg] 5 . aflx/af6 blvg]u/L RCC / l:6n Frame Structure /Vg kf0g]5g . cf/4; 4; = / :6ln Frame structure gb]vg]u/L 06f jf sf7n]5f]kl RCC / :6ln Frame structure df ejg agfpg ; lsg] 5 . RCC / :6ln Frame structure dfq agf0{ cw/f]u/L 5f8g kf0g]5g .

!@= %ofn 9f\$fx? sf7sf] xgkg] / pQm %ofn 9f\$fsf] rf8f0{ prf0{ dNnsflng, zfxsflng / /f0ffsflng z]h] cg; f/sf]cfsf/ k\$]f/sf]xg' kg\$. a0undf k/Dk/fut %ofnx? /Vg ; lsg] 5 . 9f\$df vfxf? sf7sf xgkg] / kmfd]/fln^a ; 6/, luh / rg] u] cflb aflx/af6 blvg]u/L /Vg kf0g] 5g . %ofnx? lah] dV] xgkg\$. e0{tNnfd] PsdV] %ofn dfq /Vg kf0g] 5 . c6o lj hf]dVl %ofnsf]xsdf k]t sj n)-&% ld6/ -@] ^E_ sf]b/n]GoğQd rf8f0{sfod ug{k]xG5 .

nfDrf] %ofn 9f\$fsf]prf0{/ rf\$0\$]cgkft !M-% b]v !M ; Dd xg' kg]5 . j uf\$ / emfnx?
)=()ld6/ x)=()ld6/ eGb 7hf]xg' xB ; flj s emfn 9f\$ / ; fxl z]hldf agf0Psf gofF
emfn 9f\$fsf]kpf]unf0{cfj Zostf cg; f/ k] ; flxt ug; lsg]5 .

!# = 3/sf]k]o\$ tNnf 5l6g]u/L a9ldf !%) ld= ^ 0Gr_ ; Dd uf/f\$] ; txeGb aflx/ lgsfnl
sfg] /Vg ; lsg]5 . sfg] ; se/ bf\$ af\$fsf]3/ ; # ldNg]u/L agfpg' kg\$.

!\$ = ; 8stk\$]df]8fdf cfk\$]hluf dflj kg]u/L a9ldf)=* ld6/ ; Ddsf]afb]l /Vg] ; lj wf lbg
; lsg]5 . t/ # ld6/eGb sd rf\$0\$]af\$df pk/fQm ; lj wf lb0g]5 ; rf\$ / k5f18sf]glh
hluf\$ @ ld6/sf] ; Aofs /v! ! ld6/ ; Ddsf]afb]l klxf] tNnf]v /Vg ; lsg]5 . !
ld6/eGb a9L rf\$0\$]Zos ePdf ; fxl adf]hd yk ; Aofs 5f\$] kg\$.

!% = lgodfg' f/ agfpg kfpj]cltd tNfeGb dlj dfq)=(ld6/ -# lkm_ rf\$0\$]Ddsf]angl kvf
cfk\$]hlufdf kg]u/L lgsfNg kf0g]5 . af6] / rf\$tk\$]cfk\$]hluf xgkg]j flw ul/g]5 .
kvf ; se/ bf\$ af\$fsf]3/sf]kvf / angl ; # ; 6fP/ ldNg]u/L xflg' kg\$. ejgsf]angl
kvf, dh 5fg / e\$of^ 5flg]efu ; d] @% 18ull]v #) 18ull; Ddsf]9Nsf0df agfpg' kg\$.
5fgdf clgj fo{?kdf lem=6L=6fonn]5fpg' kg\$.

rf]tNnfsf]dh 5fg k/Dk/fut g]f/L z]hlsf]b0{kvf]5fg xg' kg\$. t/ lgdf]xg]
ejgsf]ltg]t/ c?sf]3/n]3]sf]ePdf ; 8skl\$ Ps kvf]5fg /Vg cgdlt lbg ; lsg]5 .
5fgsf]jgj 6n]l5d\$lnf0{afw kg]lgsf; sf] ; d:of kg]u/L agfpg kf0g]5 . 5fg / aflx/L
efudf kgl 6df\$, l8:s P66] , Po/sl68zg ; \$, sh/ ; \$, Solar Equipment cfb ; 8s tyf
rf\$af6 b]v]u/L /Vg kf0g]5 . To:tf cfwlgs ; jfx? ; 8s tyf rf\$af6 gb]v]u/L jf
ejgsf]jf:tsndf klts h c; / gkg]u/L /Vg g-kf-n]lgbzg lbg ; Sg\$. lgodfg' f/ kfpj]
cltd tNnf; Dd gagfpg]ePdf cj :yf x]l g-kf-n]lj z]f lgbzg lbPsf]cj :ydf afx\$ e\$of^sf]
efu le/fnf]5fg /v! c6o efu sfz]sf]?kdf vNnf /Vg ; lsg\$.

!^ = clwsQd prf0{lgdf]ug]ePdf cltd -rf] tNnfd 5fgsf]%) kl]tzt; Ddsf]sfz] agfpg
; lsg\$. lj z]f kl/l:yldf ; Dalwt lj z]f1; lxtsf] ; ldtsf] /fo ln0{gu/kflnsfn] sfz]sf]
lfq]kmdf yk36 xg]u/L sfz] /Vg lbg jf glbg klj ; Sg\$.

!& = ; fdfgotof cfj; lo ejgsf] bf\$ af\$ / k5f18tk\$ %ofn 9f\$, cfL %ofn / e]6n]zg
g/flvsg kn6 hlufsf]l; dfg; Dd agfpg ; lsg\$.

!* = ; flj s 3/sf]dd\$ / tNnf yk Pj +kg]gd]sf]cj :ydf afx\$ gofFlgd]df %ofn 9f\$ tyf
e]6n]g /Vg kn6sf]l; dfgaf6 sltdf !=% ld6/ 5f8] dfq lgdf]ug{kf0g\$. olb cfj; lo
kpf]hgsf]ejgsf]lkn6y Pl/of !%) j u{k]6eGb a9L xg uPsf]cj :ydf kn6 l; dfgaf6 @-%
ld6/ 5f8L dfq lgdf]ug{lb0g\$.

%ofn 9f\$fsf]nflu 5f18g]; Aofs k]o\$ kn6sf]nflu 5f5\$}xg' kg\$. olb Pp6]kn6df
klg PseGb a9L ejg ag]ePdf k]o\$ ejgsf]5f5\$}; Aofs sfod /Vg' kg\$. bf\$ af\$tk\$
!-% ld6/ g5f8g]xf]eg]; lwof/sf]lnlvt dh/l lj g %ofn 9f\$ / e]6n]zg /Vg kf0g]5 .

-u ; lgs6 pklf

k/fgf]zx/L efusf]; fldkdf /x\$]e-efunf0{; lgs6 pklf (Buffer Sub Zone) sf]?kdf lf] lj efhg
u/L gS; df b]f0Psf]5 . lj z]ftM gu/sf ; 8s -Aof; L, dh9f\$, RofDxf; x v08_ sf]pQ/tk\$ /
dh9f\$, RofDxf; x / kl; vjh xgd]t]kh; Ddsf] ; 8ssf]k] \$km(R.O.W. b]v !) ld6/ ulx/f0{Ddsf]
lf]nf0{; d] o; }pklf]df uflePsf]5 . o; pklf]df k/DK/fut z]hlsf]3/x? ce] klg l56kn6 ?kdf
b]v65 . ; fy}gofF3/x? klg agb}u/\$]b]v65 . o; /L k/fgf]zx/L lf] / gofFlj sf; zln lf]alrsf]

; dGjo :yn (Bridge) ?kdf o; pklfjgsf]; Af0f / lj sf; xg' kg[vff] dx; ; u/l o; pklfjdf xg] lgdf; DaGwl dfkb08 lgDg adf]hd tfl]sPsf]5 .

!= o; pklfjdf lgdf xg]ejgsf]lf]km tyf prf0{lgDg adf]hd xg' kg5 M-

l; = g+	ejgsf]lsl; d	hlufsf]lf]km	clwstd u]p08 se/h	clwstd prf0{	clwstd tnf
!=	vfnl hlufdf	@ cfgf @ k} f; Dd	()%		
@=	æ	@ cfgf @ k} f eGbf a9L \$ cfgf; Dd	*)% &&) j u{ lkm6 dWb] hg a9L xG5 .		\$
#=	æ	\$ cfgf eGbf a9L ! /fkgl; Dd	&)% jf !)(% j u{ lkm6 dWb] hg a9L xG5 .	\$! lkm6 - !@=% dl=	\$
\$=	æ	* cfgf eGbf a9L ! /fkgl; Dd	^)% jf !(l& j u{ lkm6 dWb] hg a9L xG5 .		\$
%=		! /fkgl eGbf a9L	%)% jf #@*% j u{ lkm6 dWb] hg a9L xG5 .		\$
^=	; flj s kgMgdf		!))%		

@= goffejgsf]; a}tNfx?nf0{eYofax?sf]:nfk a9Ldf \$% l8ul tyf eYofasf]rf0 sldtdf)=* ld6/ xg]u/l agfpg' kg5 .

o; pklfjdf k]s[ts :nfksf]sf/0faf6 n]n l8k] ; sf]xb; Dd ; [dj] d]6 agfpg ; lsg] 5 . j] d]6 agfpg]u/l cgdlt lb0g]5g . Ps tNnf; Ddsf]; [dj] d]6nf0{sh prf0df uofgf ul/g]5g .

#= 3/sf] aflx/L efusf] uf/fdf k|6; # b|vg] u/L 06fsf] uf/f] (Brick exposed wall) xg' kg5 . emfn 9f\$fsf] lsgf/f, sfgI / jfn lkn/df rfg ; VL\$] knf:6/ ug{ ; lsg] 5 . uf/fdf l; d|6, rfg cflb /fvl knfi6/ ug{kf0g] 5g . t/ /f0ffsfnlg zhlstf 3/x?sf] ddt / kg] gdfdf ; flj s adf]hd rfg ; VL\$] knfi6/ ug{ ; lsg] 5 . aflx/af6 b|vg] u/L RCC / l:6n Frame Structure /fVg kf0g] 5g . aflx/af6 cf/4; 4; = / :6ln Frame structure gb|vg] u/L gkfnl snfTds 9uaf6 06f jf sf7n] 5fkl RCC / :6ln Frame structure df ejg agfpg ; lsg] 5 . RCC / :6ln Frame structure dfq agf0{cw/f] u/L 5f8g kf0g] 5g .

\$= %ofn 9f\$fx? sf7sf] xgkg] 5 / pQm %ofn 9f\$fsf] rf8f0{ prf0\$] cgkft !M-% b|v !M ; Dd xg' kg5 . emfnx? lj hf/dvl xg' kg5 . / kTo\$ Ps sj nsf] Gogtd rf8f0{@ lkm6 ^ 0Grtsf] b/n] rf8f0{ sfod xg' kg5 . - k/Dk/fut zhlstf emfn 9f\$fsf] ; fy; fy} dfly e|6n zgoQm emfn 9f\$; dt /fVg ; lsg5 . _

%= 3/sf] kTo\$ tNnf 5l6g] u/L a9ldf %E ; Dd uf/f\$] ; txeGb aflx/ lgsfnl sfgI /fVg ; lsg5 . sfgI /fv\$] cj :ydf ; se/ bf6f af6fsf] 3/ ; # ldNg] u/L /fVg' kg5 .

^= lgodfg' f/ agfpg kfp] clGtd tNnfefbf dlq dfq)=(ld6/ -# lkm6_ rf8f0; Ddsf] anG] kfvf cfkn] hllufdf kg] u/L lgsfnl kf0g] 5 . kfvf ; se/ bf6f af6fsf] 3/sf] kfvf / anG] ; # ; 6fP/ ldNg] u/L xfn] kg] 5 . ejgsf] anG] kfvf, dh 5fgf / efof^a 5f] g] efu ; dt @% l8ullb] #) l8ul; Ddsf] 9Nsf0df agfpg' kg5 . 5fgdf clg fo{?kdf lem6l=6fonn] 5fpg' kg5 .

rfyf] tNnfsf] dh 5fgf k/Dk/fut g] f/L zhlstf] b0{kfv] 5fgf xg' kg5 . t/ lgdfdf xg] ejgsf] lgt/ c?sf] 3/n] 3] \$] ePdf ; 8skl\$ Ps kfv] 5fgf /fVg cgdlt lbg ; lsg] 5 . 5fgsf] jgf] 6n] l5d\$lnf0{afwf kg] / lgsf; sf] ; d:of kg] u/L agfpg kf0g] 5g . 5fgf / aflx/L efudf kfgl 6dfsl, l8:s P66df, Po/sl68zg ; \$, sh/ ; \$, Solar Equipment cflb ; 8s tyf rf\$af6 b|vg] u/L /fVg kf0g] 5g . To:tf cfwlgs ; jfx? ; 8s tyf rf\$af6 gb|vg] u/L jf ejgsf] jf: t\$nfdf klTsh c; / gkg] u/L /fVg g-kf-n] lgbzg lbg ; Sg] 5 . lgodfg' f/ kfp] clGtd tNnf; Dd gagfpg] ePdf efof^a sf] efu le/fnf] 5fgf /fvl cGo efu sfzlsf] ?kdf vNnf /fVg ; lsg] 5 .

&= ; 8s tkmf] dfxbdf cfkn] hllufdfly kg] u/L a9ldf ! ld6/; Ddsf] afbfl /fVg] ; lj wf lbg ; lsg] 5 . t/ # ld6/eGb sd rf8f0\$] af6df pk/fQm ; lj wf lb0g] 5g . rf\$ / k5fl8sf] lghl hlluf tkm @ ld6/sf] ; \$Aofs /fvl ! ld6/; Ddsf] afbfl klxfn] tNnf] /fVg ; lsg5 . ! ld6/eGb a9l rf8f0{cfj Zos ePdf ; fxl adf]hd yk ; \$Aofs 5f8g' kg5 .

*= clwsQd prf0{lgdfdf ug] ePdf clGtd -rfyf] tNnfdf 5fgsf] &% klTzt; Ddsf] sfzl agfpg ; lsg5 .

(= o; pklfdf ; flj s adf]hd ddt, tNnf yk / kg] gdfdf afx\$ gof] gdfdf xg] sg] klg 3/ jf ejgdf af6f] km{slTdf ! ld6/ 5f8] dfq lgdfdf ug{ ; lsg5 .

k/Dk/fut ; f:s[ts cfj f; lo lfdf lgdfdf xg] ; fj hlgS ej g ; DaGwl lj zif Joj :yf

o; pklfdf ; /sf/L, cw{ ; /sf/L, u} ; /sf/L / ; fdlhs ; \$, ; ysf ejg, klyds lj Bfno, tlnf s|b, klTi7fg cflb ; dt agfpg kf0g] 5 . sl ju\$] ejg agfpg kf0g] 5g . vl ju\$] ejgsf] xsdf Ps] fl6 w] ; df65x?sf] el8 xg] rnlrq ejg, c:ktn, ; efux, wld\$ tyf glts kj rg lbg] s|bx?, snhx?sf] nflu cgdlt lb0g] 5g . cGo ; fj hlgS ejgx?sf] nflu lj zif Joj :yf lgDg adf]hd xg' kg5 M-

!= ..vl j u\$]ej gsf]nflu hlu fsf]Go gtd Ps /fkgleGbf sd xg' xBj .

@= uf p08 se/h sf]xsdf lj leGg j u\$]; fj h lgs ej gsf]nflu lgDgfg; f/ Joj :yf ul/Psf .
..vl j u\$]ej gsf]nflu clwstd uf p08 se/h \$) kltzt; Dd lbg ; lsg\$ / ..ul j u\$]ej gsf]
nflu bxf0 adf]hd clwstd uf p08 se/h lbg ; lsg\$ M-
hlu fsf] lfk m clwsQd kfp g]uf p08 se/h
)-@-@-) ; Dd *) kltzt
)-@-@-) eGbf a9L \$-)-) ; Dd &) kltzt
)-\$-)-) eGbf a9L)-*--)-) ; Dd ^) kltzt jf (%* j u{lkmbdWo]hg a9L xG5
)-*--)-) eGbf a9L !-)-)-) ; Dd %) kltzt jf !^\$# j u{lkmbdWo]hg a9L xG5
!-)-)-) eGbf a9L \$) kltzt jf @&#* j u{lkmbdWo]hg a9L xG5
; flj s kgM lgdf

#= clwsQd prf0 M- ej gsf] clwsQd prf0{ ; Aift :df/s pklfg / ; f:s[ts ; Dkb f pklfgdf
!)=& ld6/ -#%l)A_ / ; Ggls6 pklfgdf !#=& ld6/ -\$%l-)a_ ; Dd cgdlt lbg ; lsg\$.

\$= ej gsf] clwsQd tNnf ; Aift :df/s pklfg / ; f:s[ts ; Dkb f pklfgdf # tNnf / ; Ggls6
pklfgdf \$ tNnf; Dd cgdlt lb0g]5 .

%= tNnfsf]prf0{ ; Aift :df/s pklfg / ; f:s[ts ; Dkb f pklfgdf @=&\$ ld6/ -(lkm_ ; Dd /
; Ggls6 pklfgdf cfj Zostf cg; f/ /Vg ; lsg\$.

^= ; 8s dfkb08 lgwf{Of ePsfdf ; 8s dfkb08df yk @ ld6/ 5fB} agfpg' kg\$. ; 8s dfkb08
lgwf{Of gePsfdf ..vl j u\$]ej gsf]nflu tlg ld6/ ul j u\$]ej gsf]nflu ! ld6/ 5f8y' kg\$.

&= ..vl j u\$]ej gsf]nflu # ld6/ /Vg' kg\$. t/ ..vl j u\$]ej gsf] ; lj wf / Joj :yfkgsf] nflu
agf0g]uf8{xfp; ; e{6 Sj f6/, lj B't ; a :6zg, kDk xfp; cflb Ps tNn]kF ld6/eGbf xfrf]/
) j u{lkmbegbf sd lknGy Pl/of ePsf 6x/fx? / ..ul j u\$]c6o ; fj h lgs ej gsf] nflu
hlu fsf]l; dfgf; Dd agfpg ; lsg\$.

*= ..vl j u\$]; fj h lgs ej gsf]nflu # ld6/ /Vg' kg\$. t/ ..vl j u\$]ej gsf] ; lj wf / Joj :yfkgsf]
nflu agf0g]uf8{xfp; ; e{6 Sj f6/, lj B't ; a :6zg, kDk xfp; cflb Ps tNn]kF ld6/eGbf
xfrf]/ @)) j u{lkmbegbf sd lknGy Pl/of ePsf 6x/fx? / ul j u\$]c6o ; fj h lgs ej gsf]nflu
hlu fsf]l; dfgaf6 @ ld6/ 5f8L agfpg ; lsg\$.

(= dh eYof^a tyf s/l8f] Go gtd rfBf0{!-% ld6/ -% lkm_ xg' kb\$. eYof^a sf]Tread sf]Go gtd
rfBf0{!! OGr l / Riser sf]clwsQd prf0{& OGr xg' kg\$. olb kIo\$ tNnfd f Floor Area
@%) j u{lkmbegbf a9L xg] / Travel Distance @% ld6/ eGbf a9L uPsf]cj :yfdf c6o
; fj h lgs ej gsf]xsdf klg Go gtd ! j6f yk ; xfos eYof^a xg' kg\$. To:tf ; xfos eYof^a sf]
rfBf0{Go gtd ! ld6/ xg' kg]5 . %) j u{lkmbegbf a9L lknGy Pl/of ePsf ej gx?df cktw
tyf c; Om JolQmx?; d: e0f-tNnf / zfrno; Dd klg ; Sg]u/L Ramp sf]Joj :yf ug[kg\$.
; f\$]rfBf0 Go gtd ! ld6/ /Vg' kb\$ / Ramp agfpg !M) eGbf a9L :nfk /Vg' xBj .

!)= ej gsf] ; Argfut ; /lffsf] ; fy; fy}cfs l:ds cj :yfdf kpf]ustf{x?sf] ; /lffdf ; d: kltsh
c; / gkg]u/L lgdf ug{kg\$. kpf]ustf{x?sf]cfs l:ds ; /lffnf0{bl6but u/L e\$Dk lg/vys
; Argf l8hf0gsf] ; fy; fy}Emergency Exit / Fire escape sf] ; d: Joj :yf ug[kg]5 . o:tf
ej gx?df ckt sfnlg dfu{ ; \$:x? kI6 ?kdf blvg]u/L /Vg' kg\$.

!!= ..vl ju\$; fj hlg\$ ejgx?sf]nflu sh Build up Area sf]@) k|tzt; Dd kfls{sf]Jo] :yf ug{k\$g\$.

!@= /fli60 ejg ; ktf (National Building code) df cfwfl/t e0{:yfglo lgsfoaf6 tof/ ul/g] lgb|zsfdf tfl]sPsf]kfj wfgx? ; d] kngf ug{k\$g\$.

kgZr M dflv pNn]vt afx\$ c6o kfj wfgx? cfj f; lo ejgs}dfkb08 nfu"x\$g\$.

gfb M ..sl ju{M cl86fl/od, l; gdfxn, ckf6d]6 ; efu{x h:tf ejg h:sf]sh prf0{!^ ld6/ jf % tNnf e6bf a9L x65 .

..vl ju{M sh prf0{!)-&- !^ ld6/ jf \$ jf % tNnf; Dd ePsf jf xhf/ ju{lkmb e6bf a9L lkn6y Pl/of ePsf ; fj hlg\$ ejg hgfp\$.

..ul ju{M xhfs, :yfglo Snj, j 8f sfoffo / ; 3 ; :yfsf ejgx? h; sf]sh prf0{!)-& ld6/ -#% lkmb_ e6bf a9L gePsf]/lkn6y Pl/of !))) ju{lkmb e6bf sd / tlg tNnf ebf sd ePsf]ejgx? hgfp\$.

@= lj sf; zln lfq M

k/Dk/fut zx/L lfq (core Area) sf]l; dfgb]v gu/ l; dfgf; Ddsf]e"efudf tfl]sPsf xl/t lfq afx\$sf]efunf0{lj sf; zln lfq egl tfl]sPsf]5 .

o; lfqdf thgf]ds ?kdf a9L vnl hluuf /x\$]f/ cfj f; lo / c6o kpf]hgsf]3/x? a6g] qmd cem}a9b}hfg]l:yltdf ePsf]h]plrt of]hg / Jo] :yfk\$; d]sf]cfj Zostf dx; ; ul/Psf]5 . o; lfqnf0{j t6fg pkof] / ; e]Jotfnf0{d]logh/ u/L of]hg]4 lj sf; sf]nflu e"pkof] gSzdf b]fP h:t}lgDg Inlvt \$ pklfqdf lj efhg ul/Psf]5 .

s= cfj f; lo pklfq

v= lj z]f of]hg]fut pklfq

u= cf]B]lus pklfq

3= Jofkl/s pklfq .

s= cfj f; lo pklfq M-

k/Dk/fut cfj f; lo pklfq, lj z]f of]hg]fut pklfq, cf]B]lus pklfq / Jofkl/s pklfq afx\$sf]o; dfkb08n]lgifw gul/Psf cfj f; agfpg of]lo e"efunf0{cfj f; lo pklfq egl tfl]sPsf]5 . j 8f g=\$ l:yt lgb|zt hluuf lj sf; G.L.D. 3fl]ft lfqsf]e"efudf eljiodf Pslst cfj f; cfof]hg] ; #fng ug{ pkoQm b]v65 . t/ cfof]hg] ; #fng e0{k/f geP; Dd o; }pklfq c6tu{sf]lgod nfu"ul/g]5 . o; pklfqdf lgdf ul/g]ejg cflbsf]lgdf ; Da6wl dfkb08 lgDg adf]hd lgw{of ul/Psf]5 M-

!= o; pklfqdf ; fl]s adf]hd dd / k]lgdf of]afx\$ vnl hluufdf gofF3/ lgdf ubf{ejgsf] clwsQd uf]p08 se/h lgDg adf]hd sfod ul/Psf]5 M-

! = g+	ejgsf]lsl; d	hlufsf]lfqkm	clwstd uflp08 se/h	clwstd prf0{	clwst d tnf	tnfsf] prf0{
!=	vfnl hlufdf	\$ cfgf; Dd	&)%	\$% lkm6	%	(lkm6 -@-&\$
@=		\$ cfgf b]v * cfgf; Dd	^)% jf (%* ju{ lkm6 d]lo] hg a9L xG5 .	\$% lkm6	%	dl= (lkm6
#=		* cfgf b]v ! /f]kgl; Dd)%)% jf !^\$# ju{ lkm6 d]lo] hg a9L xG5 .	\$% lkm6	%	æ
\$=		! /f]kgl eGbf a9L	xG5 . \$)% jf e&#* ju{ lkm6 d]lo] hg a9L xG5 .		%	æ

@= R.O.W lgwfl{0f ePsf af6f?df a9Ldf)=() ld6/; Dd kpl=v8\snf /fVg ; lsg] 5 . o; /l kpl=v8\snf /fVbf ; se/ bf6f-af6fsf] 3/; u ldNg] u/L /fVg' kg5 . \$ ld6/eGbf sd rf8f0{ ePsf]af6f\$]xsdf)=% ld6/; Ddsf]dfq kpl=v8\snf /fVg kf0g5 .

#= eYofEsf]Gogtd rf8f0)=() ld6/ -#l)-_ xg' kg5 / :nfk a9Ldf \$% l8ul xg' kg5 . v8\snf] prf0{clwsQd *E / v8\snfsf]6\$g]efu Gogtd (E xg' kg5 .

\$= hlufsf] k]s[ts :nfksf] sf/0faf6 n]n l8km[]; sf] xb; Dd ; dlj] d]6 agf0{ 3/ lgdf0f ug{ kf0g5 . Ps tNnf; Ddsf]; dl j] d]6nf0{prf0df u0fgf ul/g]5g . t/ ; dl j] d]6 Pse6bf a9L ag]cj:yf ePdf tNnf]; dl j] d]6eGbf dflysf] tNnfsf]e0]v ; f]v08 jf gfnfsf]sh prf0{ gflkg5 . j] d]6 hlufsf] tNnf] uflp08 n]nblv a9Ldf \$ ld6/ ulx/f] Dd agfpg ; lsg5 . j] d]6nf0{sh prf0df u0fgf ul/g]5g . j] d]6 agf0f ; fwsf cGo 3/ tyf ; Argfnf0{jfwf gkg]u/L pkoQm klj lw ckgf0{ ; /lft 9un]agfpg' kg5 . j] d]6 lgdf0f]qmdf ; fwsf 3/ tyf ; Argfnf0{c; / k/]f jf cGo lsl; dsf]lflt ePdf ; f]sf]lhDd]f/L lgdf0fstf{cfkm}]j xg ug{kg5 .

%= ; 8ssf] d]lo /yfsf] prf0af6 /fVg kf0g] clwsQd lkn6y prf0sf] ; DaGwdf snf]kq] ; 8ssf] nflu)=^) ld6/, ufln ; 8ssf] nflu)=&% ld6/, slRr ; 8ssf] nflu)=() ; Dd agfpg ; lsg5 . lkm8df af6f] galg; s\$]f] cj:yfdf cijZostf cg; f/ /fVg ; lsg5 . lgdf0f:yn

; 8se6bf xfrf] jf prf0{f eP 9n lgsf; ; r? ?kn]; #fng xg] lsl; dsf] ej gsf] lknGy agfpg' kg5 . lknGysf]prf0{; se/ bf6f af6f 3/; # ldnG]u/L /fVg' kg5 .

^= ej gsf]Gogtd rf8f0{; fdf6otof @=\$) ld6/ xg' kg5 .

&= ej gsf] k|o5 sf7fx?df /flvg] vNnf em6fn, 9f5f tyf e|66nzgsf] efu ; f] sf7f]sf] e06] 9flsPsf] lfkmsf]Gogtd !) kl|tzt xg' kg5 . :6f] / khf sf7f afx5 c6o sf7fx?df kof6t k5fz / qm; e|66nzgsf]JoJ :yf xg' kg5 . ; fdf6otof **Built up Area** sf]@% kl|tzt; Dd dfq :6f] / khf sf7f]sf]?kdf /fVg kf0g5 .

*= ej galrsf] 6k÷5Hhf clwsQd)=^)ld6/ tyf 5fgfsf] nflu clwsQd)=()ld6/; Ddsf] xg' kg5 . em6fn, 9f5f dfly 5Hhfsf]?kdf)=^)ld6/; Dd /fVg ; lsg5 .

(= >vfnj 4 3/x?sf] xsdf 06f b|vfp' -Brick Expose) kg5 . t/ em6fn 9f5f]sf] lsgf/f, sfgI / jfn lkn/df knf:6/ ug{ ; lsg5 . c; j+4 3/x?sf] xsdf cfj Zostf cg' f/ lknlg; ^ ug{ ; lsg5 .

!)= >vfnj 4 3/x?sf] xsdf uf/f5f] ; tx aflx/ cfpj] (Projected) em6fn 9f5f /fVg kf0g] 5g . k/Dk/fut z|hsf em6fnx?sf] ; fy; fy}dfly e|66nzgoQm em6fnx? ; dt /fVg ; lsg5 . c; j+4 3/x?sf] xsdf cfj Zostf cg' f/sf] cfsf/ k5f/ / :j?ksf] em6fn 9f5f /fVg ; lsg5 . Uof/h / k; n kof]hgsf] nflu kmfdfs] /f]nE ; 6/; r6g u6 ; dt /fVg ; lsg5 .

!!= k|o5 tNnf 5l6g]u/L a9ldf !%) ld4d=; Ddsf] sfgI /fVg ; lsg5 . sfgI ; se/ bf6f af6f]sf] 3/; # ldnG]u/L /fVg' kg5 .

!@= t] f] tNnfd)=()ld6/; Ddsf] 5fgf / kvf /fVg ; lsg] 5 . 5fgf cfj Zostf cg' f/ kn6f6 j f :nfk ug{ ; lsg5 .

!#= kn6f6 5fgf ePsf] xsdf lgodfg' f/ kfpj] cl6td tNnfd Gogtd ## kl|tzt sfzL /fVg' kg5 .

!\$= lgdf6f ug] ej gaf6 kn6df lgDg cg' f/ ; 6Aofs 5f]8Psf] xg' kb5 . ; 6 Aofs b'/ldf ROW lgwf{0f ePsf] ; 8sdf a9ldf)=()ld6/; Dd v8l5nf jf k6L /fVg ; lsg] 5 . @(-)E ; Ddsf] 6k jf kvf afx5 afb6l Sof66ln6/, sf7f cflb pQm ; 6Aofs b'/ldf kg]u/L dflyNnf] tNnfd lgsfNg kf0g] 5g . olb afb6l Sof66ln6/ cflb lgsfNg] xf] eg] ; f] tkm(e06Nnfsf] aflx/L leQfsf] ; txb]v Projection ePsf] rf8f0 a/fa/sf]yk ; 6Aofs 5f8g' kg5 .

-v_ **lj zif of]hgfut pklf6**

o; pklf6df Psls[hlu f lj sf; sfo6md c6tu6 sdnlj gfos cfj f; of]hgf, lnj fnl cfj f; of]hgf / rfyf, t6rf] / bu/] cfof]hgfleqs k6x? kb5g\ elj iodf ; #fng xg] c6o Psls[hlu f lj sf; sfo6md lf6sf] xsdf lj zif ?kdf l; kmf/; ul/Psf] cj :ydf afx5 ; fdf6otof o; } pklf6sf] lgod nfu" ul/g] 5 . j8f g=\$ l:yt G.L.D. lf6 ; dt cfj f; of]hgfsf] nflu ; efJotf lf6 ePsf] r/Ofj 4 ?kdf Psls[cfj f; of]hgf nfu" ug] / of]hgf ; DkGg ePkl5 :j tM o; pklf6df ufleg5 . o; lf6df lgdf6f ul/g] ej gsf] nflu lgdf6f ; Da6wl dfkb08 lgDg adf]hd tfl]sPsf] 5 .

o; lf6df ; flj s adf]hd dd6 / kg]lgdf6df afx5 vfnl hlu fdf gofF3/ lgdf6f ubf{ej gsf] clwsQd uf]p08 se/h lgDg adf]hd sfod ul/Psf] 5 #

l; = g+	ejgsf]lsl; d	hlufsf]lfqkm	clwstd uifp08 se/h	clwstd prf0{	tnfsf] prf0{	clwstd tnf
!=	vfnl hlufdf gofF3/ lgdfQf ubf{	\$ cfgf; Dd	&)%	\$% lkm6 -!#-& dl=_	*l)l -(l)æ -@=\$% - @=&\$ dl=_	% -e-ofE 5f]g] ; lxt_
@=		\$ cfgf b]v * cfgf; Dd	^)% jf (%* ju{ lkm6 d]w] hg a9L xG5 .	\$% lkm6	-eE{ tNnfd # ld6/; Dd /Vg ; Sg5_	
#=		* cfgf b]v ! /fkgl; Dd	%)% jf !^\$# ju{lkm6 d]w] hg a9L xG5 .			
\$=		! /fkgl eGbf a9L	\$)% jf @&#* ju{lkm6 d]w] hg a9L xG5 .			

#= lj z]f klj wfg M

lj sl; t kn6af6 k0f{?kdf l; }kn6afx\$; f] sf] sg}6qmf lemsl laql ug{k/df jf cGo sg}k\$ f/sf] gfd; f/L ug{k/df o; lj lgodfj nl -dfkb08_ sf]uifp08 se/h / lgdfQf:yn ; DalwL cfwf/et Joj :yfx? k0f{of kfng u/L alg; s\$]ejgsf]j l/kl/ 5f8g' kg]hluf hlt xf] ; f]5f8L af5L hluf dfq gfd; f/L a]ljvg ug{ kf0g5 . ; f] k0f]ngsf] nflu To:tf kn6x? 6qmf0{ gfd; f/L ug{ ; Dal6wt cfof]hgf gu/kflnsf jf gu/ lj sf; sf]l; kmf/; lng' kg5 . ; f]l; kmf/; sf] cfwf/df dnfkf] sfof]hon]kn6x? 6qmf0 lbg ; Sg5 . lsQsf6af6 afg]gofRkn6x?sf]Gogtd lfqkm)-@-@-) / dfx8f ^ ld6/ xg'kg5 .

-u_ cfBflus pklfQ

o; pklfQ cgtut eQmk/ ; fgf]cfBflus lfQ / ; f]lv klZrdtkm{gu/sf5 ; 8s / ; Nnf3f/L, bW kf6L ; 8salrsf] ; #lft lfQ / xl/t lfQ afx\$sf]e"efu kg5 . o; lfQdf xfn klg cfBflus ultlj lwx? a9g] qmddf /x\$fh]kl5; Dd cfBflus k0f]ngsf]nflu lj sl; t ub]nlug]5 . o; lfQdf sn, sf/vfgf, ufbfdx? pBflus]gfd dfq 3/ agfpg :jls[t lb0g5 . o; lfQdf kz; kG5L kfng (Livstock) Joj ; fosf]nflu cgdlt lb0g]5g . o:tf ejgx?sf] nflu Pq lgodn]gkfn ; /sf/ cgtut ; Dal6wt lgsfo -pBfl

dGqfno, jftfj /Of dGqfno / :jf:Yo dGqfno cflb_ sf] lj zif cgdlt rflxg] Joj :yf u/ \$f] v08df ; f] cg' f/ cgdlt ln0{kz ug{kg}5 . o; pklf qdf lgdf qf ; DaGwl dfkb08 lgDg adf]hd xg}5 .

!= ejgsf] lfgkmm tyf prf0{

o; lfgdf lgdf qf xg] ejgsf] lfgkmm / prf0{lgDg adf]hd xg' kg}5 M-

S= Kn6 hlufsf] \$) kltzt; Dd dfq 9fsl ejg agfpg kf0g}5 . sn sf/vfgf; # ; DalGwt sfoffno ejgsf] xsdf sf/vfgf ejgsf] Built up Area sf] @) kltzt; Dd dfq cgdlt lb0g}5 .

v= ejgsf] clwsQd prf0{ejgsf] k\$[t x]l lgDg adf]hd xg]5 . prf0{rf}f0{sf] # u0ffeGbf a9L xg' x}5 . sn, sf/vfgfsf] xsdf ; fdfGtof !^ ld6/ / ; f] ; DaGwl sfoffno ejg, uf}f}dsf] clwsQd prf0{!}& ld6/; Dd xg' kg}5 . sh prf0{lnbf lknGw n] nb]v ejgsf] ; j}f}r lj Gb' Ddsf] b'lnf0{ln0g}5 . prf0{a9L rflxg] k\$[tsf lj zif sn sf/vfgf ejg tyf cG0 ; Argfsf] nflu c}rTo x]l g=kf=n] prf0{df yk ; xlnot lbg ; lsg}5 .

u= sf/vfgf / uf}f}d ; fdfGtof ! tNnfsf] dfq xg]5 / ; f] # ; DalGwt sfoffno tlG tNnf; Ddsf] xg ; Sg}5 . lj zif kl/l:yltdf sf/vfgfsf] k\$[t / cfj Zostf x]l ; f}Gbf a9L klG c}rTo x]l lbg ; lsg}5 .

3= sn sf/vfgf ejgsf] nflu tNnfsf] prf0{cfj Zostf cg' f/ /Vg ; lsg}5 . t/ ; f] # ; DalGwt sfoffno ejgsf] xsdf k}o\$ tNnf !) lkm6; Ddsf] prf0{df agfpg ; lsg}5 .

a= ROW lgwf{Of ePsf af6f}df a9Ldf)=() ld6/ ; Dd k}L=v8}nsnf /Vg ; lsg}5 .

r= eYofEsf] Gogtd rf}f0 ! ld6/ -#l-#E_ xg' kg}5 / :nfk a9Ldf \$% l8ul xgkg}5 . v8}nsnf prf0{clwsQd *E / v8}nsnfsf] 6\$g] efu Gogtd (E xg' kg}5 .

5= hlufsf] k}f]s[ts :nfk}sf] sf/Ofaf6 n] n l8km}l; sf] xb; Dd ; }l] j] d}6 agf0{3/ lgdf qf ug{ kf0g}5 . Ps tNnf; Ddsf]; }l j] d}6nf0{prf0{df u0fgf ul/g}5 . t/ ; }l j] d}6 PseGbf a9L ag]cj :yf ePdf tNnf]; }l j] d}6eGbf dflysf] tNnfsf] e0}v ; f]v08 jf gfnfsf] sh prf0{ gflkg}5 . j] d}6 rflx+hlufsf] tNnf] u}p08 n}nb]v a9Ldf \$ ld6/ ulx/f] Dd agfpg ; lsg}5 . j] d}6nf0{sh prf0{df u0fgf ul/g}5 . j] d}6 agf}f ; fwsf cG0 3/ tyf ; Argfnf0{jfwf gkg}u/l pkoQm klj lw ckgf0{; %lft 9un] agfpg' kg}5 . j] d}6 lgdf qf sf] qmddf ; fwsf 3/ tyf ; Argfnf0{c; / k}df jf cG0 lsl; dsf] lft ePdf ; f]sf] lhd}f/l lgdf qf stf{cfkmm} j xg ug{kg}5 .

@= sf/vfgf / uf}f}d ejgsf] xsdf ; 8ssf] d}wo /v}fsf] prf0{af6 /Vg kf0g] clwsQd lknGy prf0{sf] ; DaGwdf snf}kq; 8ssf] nflu)=^) ld6/ , uf}an ; 8ssf] nflu)=&% ld6/ , slRr ; 8ssf] nflu)=() ; Dd agfpg ; lsg}5 . sf/vfgf ejgsf] xsdf cfj Zostf cg' f/ /Vg ; lsg}5 . lgdf qf :yn ; 8seGbf x}f}f] jf prf0{df eP 9n lgsf; ; r? ?kn] ; #fng xg] lsl; dsf] ejgsf] lknGy agfpg' kg}5 . af6] galg; s}f] cj :ydf e"agf} cg' f/ lknGysf] prf0{cfj Zostf cg' f/ /Vg ; lsg}5 . lknGysf] prf0{ ; se/ bf}f af}f 3/ ; # ldNg] u/l /Vg' kg}5 .

#= ejgsf] Gogtd rf}f0{@=\$) ld6/ xg' kg}5 . ejgsf] prf0{/ rf}f0{sf] cgkftdf ; se/ #M eGbf a9L xg' x}5 .

\$= ejgsf] k}o\$ sf}fx?df /flvg] vNnf em}n, 9f}sf tyf e}Gn}zgsf] efu ; f] sf}f}sf] e0} 9flsPsf] lfgkmsf] Gogtd !) kltzt xg' kg}5 . :6f / khf sf}f afx\$ cG0 sf}fx?df kof{t k\$z / qm; e}Gn}zgsf] Joj :yf xg' kg}5 .

%= cfj Zostf cg; f/sf] emfn 9f\$fsf] cfsf/ k\$ f/ /Vg ; lsg] 5 / kmfdfs] /fl]nE ; 6/, rđ uđ ; d] /Vg ; lsg] .

^= af6f] km{lgwf{/t ; 8s dfkb08 cg?k ; }Aofs 5f8g' kg] . ; 8s dfkb08 lgwf{/t geP sIDtdf # ld6/ 5f8] dfq lgdf{ ug{kf0g] . bfaf6f] hf]8g]: yfgsf] xsdf ; 8s lj efua6 tf]sPsf] dfkb08 nfu" xg] . t/ pBf] ejgsf] nflu cfj Zos uf8{ xfp; , kDk xfp; , lj B't ; j : 6zg, ; e]6 Sj f6/ h: tf Ps tNn] % ld6/ eGb] sd prf0\$ b0{ ; o ju{ lkmbeGb] sd se/ h ePsf 6x/ fx? ; 8s dfkb08 lgwf{/t geP ! ld6/ 5f8] lgdf{ ug{kf0g] .

&= ; fdfGotof ejgsf] bf{f af{f / k5fl8tkm{ %ofn 9f\$ f g/flvsg kn6 hlufsf] l; dfgaf6 # ld6/ -!)) A_ ; }Aofs sfod /Vg' kg] . t/ pBf] ejgsf] nflu cfj Zos uf8{ xfp; , kDk xfp; , lj B't ; j : 6zg, ; e]6 Sj f6/ h: tf Ps tNn] % ld6/ eGb] sd prf0\$ b0{ ; o ju{ lkmbeGb] sd se/ h ePsf 6x/ fx? l; dfg; Dd agfpg ; lsg] .

*= kn6sf] l; dfgaf6 sIDtdf # ld6/ -!)) A_ 5f8] dfq lgdf{ ug{kf0g] . %ofn 9f\$fsf] nflu 5f8g]; } Aofs k]o\$ kn6sf] nflu 5\$5\$} xg' kg] . olb Pp6} kn6df klG PseGb] a9L ejg aGg] ePdf k]o\$ ejgsf] 5\$5\$}; }Aofs sfod /Vg' kg] . t/ pBf] ejgsf] nflu cfj Zos uf8{ xfp; , kDk xfp; , lj B't ; j : 6zg, ; e]6 Sj f6/ h: tf Ps tNn] % ld6/ eGb] sd prf0\$ b0{ ; o ju{ lkmbeGb] sd se/ h ePsf 6x/ fx? df l; dfgaf6 @ ld6/ 5f8L emfn 9f\$ f /Vg ; lsg] .

(= pBf] uaf6 pTkfbg xg] km{x} d] hf jftf] / oflo kb] fof gxg] u/L Joj: yfkg ug{ kg] . /; fogoQm t/n kbfx? cfj Zos treatment -pkrf/_ kl5 dfq 9n lgsf; jf gbldf hfg] u/L plrt Joj: yf ug{ kg] . pBf] usf] u} lhDd] f/ laf6 jftf] / of tyf vf] hf kl] tsh c; / k/ \$f] alemg cfPdf g-kf-n] cfj Zos sf/ jxl ug{; Sg] .

!)= dnb/, sd{f/L, pTkfbg klqmf / dnb/x?sf]: jf: Yo, ; kmf0{/ ; /lffsf] k] lnt >d Pđ adf] lnd Joj: yf u/ \$f] xg' kg] . kpf] ustf{?sf] cfs] ds ; /lffnf0{ b] l] but u/L e\$Dk lg/ f] ws ; Argf l8hf0gsf] ; fy; fy} 0dh]; L PlSh8 (emergency Exit) / Firescape sf] Joj: yf ; d] ug{ kg] . w} } dflg; x? sfd ug} pBf] ejgx?df cfktsfnlg l: y] tsf] ; s] ug{ oGqx? / cl] lglg/ f] ws oGqx?sf] ; dlrt Joj: yf xg' kg] . o: tf ejgx?df cfktsfnlg dfu{; s] x? k] b ?kdf b] lvg] u/L /Vg' kg] .

!!= /fli6@ ejg ; }tf (National Building code) df cfwfl/ t e0{g-kf-af6 tof/ ul/g] lgb] zsfdf tf] sPsf] klj wfgx? ; d] kfngf ug{ kg] .

-3_ Jofkl/s pklfđ M-

c/lgsf] /fhdfu\$] pQ/tkm{/ xgdGt] vf] hf] sf] bl] f0ftkm\$] xl/ t lřđ afx\$sf] gu/sf] e"efunf0{ Jofkl/s pklfđ egl tf] sPsf] 5 . oftofts] /fd] ; lj wf / l5d\$ l a: tlx? ; } lgs6tfn] ubf{o; lřđ Jofkl/s ult] lw al9/x\$] / /fhwfglnf0{ k] { g] kn; } hf] 8g] agk] alb] f; sf] af6] lgdf{ffwlg cj: ydf /x\$] / ; f] sf] lgdf{ ; DkGg ePk15 ol ult] lwx? cem} a9b} hfg] kž: t ; e] jf ePsf] h] o; lřđsf] ; lglZrt lj sf; cfj Zos b] lV65 . Jofkl/s kpf] hgsf] nflu Joj xfl/s xg] lsl; dn] s] l ; lj wf x? ; d] lbb} o; pklfđsf] nflu lgdf{ ; DaGwl dfkb08 lgDg adf] lnd lgwf{/ of ul/ Psf] -

!=

!= g+	ejgsf]lsl; d	hlufsf]lfqkm	clwstd uifp08 se/h	clwstd prf0{	tnfsf] prf0{	clwstd tnf
!=	vfnl hlufdf gofF3/ lgdf@f ubf{	\$ cfgf; Dd	&)%	!^ dl= - 3/sf]prf0{ rf8f0\$# u0ff e6bf a9L xg' x65g .	!)ú - # dl=_	% !)ú -# dl=_ - e0\$#] tnf !@ú ; Dd /fVg ; Sg] 5 _
@=		\$ cfgf b]v * cfgf; Dd	^)% jf (%* ju{ lkm6 d]w] hg a9L x65 .			
#=		* cfgf b]v ! /f]kgl; Dd	%)% jf !^\$# ju{lkm6 d]w] hg a9L x65 .			
\$=		! /f]kgl e6bf a9L	\$)% jf @&#* ju{lkm6 d]w] hg a9L x65 .			

kgZr M c/lgsf]/fhdfu{ u hf]8Psf]lsQsf] xsdf af6f]km(lgodfg; f/ hluf 5f8bf k5f18 af5L xg] hlufsf]rf8f0{* dl6/; Dd ePsf]cj:yfdf af5L hluf k/f se/h agfpg ; lsg5 .

@= ; 8ssf] d]w] /]fsf]prf0{af6 /fVg kf0g] clwsQd lkn6y prf0\$#]; Da6wdf sfnf]kq]; 8ssf] nflu !=@ ld6/, u]af]h ; 8ssf]nflu !=% ld6/, slRr ; 8ssf]nflu !=* ; Dd agfpg ; lsg5 . lgdf@f:yn ; 8se6bf x]f]f]jf prf0{df eP 9n lgsf; ; hf? ?kn]; #fng xg]lsl; dsf]ejgsf] lkn6y agfpg' kg5 .

#= !))) ju{lkm6; Ddsf]ejgdf e%ofEsf]Goçtd rf8f0 !=) ld6/ -#ú #_ xg' kg5 ; f]lfqkme6bf a9L ePdf e%ofEsf Goçtd rf8f0{!=@) ld6/ -ú) #_ xgkg5* / :n]k a9Ldf \$% l8uú xg' kg5 . v8]nsf]prf0{clwsQd *E / v8]nsf]6\$g]efu Goçtd (E xg' kg5 . olb kmnf] Pl/of @%) ju{lkm6e6bf a9L ePdf yk Pp6f ; xfos e%of^sf]Jo] :yf ug{kg5 . To:tf ; xfos e%of^sf]Goçtd rf8f0{! ld6/ xg' kg5 .

\$= ; 8ssf]5\$}gfd / dfkb08 lgwf{of ePsf c/lgsf]/fhdfu{afx\$ cfo af6f]df R.O.W. kl5 @ ld6/ ; 8Aofs 5f8g' kg5 . o; /L 5f18Psf]b/L - R.O.W. kl5 @ ld6/_ leq dflyNnf]tNnfd !

ld6/; Ddsf] SoflG6nēn projection ug{; lsg5 . c6o uf77f] rng rNtLsf]af6f]/ lghl af6f0f
c6o lř0df h:t} tfl]sPsf]dfkb08 5f8l lgdf0f ug{kg5 . bfaf6f] hf]8g] :yfgsf] xsdf ; 8s
lj efuaf6 tfl]sPsf]dfkb08 nfu"xg5 .

k] {lgwf/t ; 8s dfkb08 cg?k lgdf0f ul/Psf]ejgdf rfn"dfkb08 adf]hd ; 7Aofs
gku bl]vPdf klg tNnf yk / dd{ ug{lbg ; lsg5 . t/ hu; Dd eTsfp/ kgM lgdf0f ug{x sdf
eg]rfn"; 8s dfkb08 cg?kg}; 7Aofs /fVg' kg5 .

%= s0b|o tyf c6o ahf/ -lj zfn ahf/, l8kf6006n :6f], ; k/ dfs7 Maxpkof]ul Jofkl/s sDkn\$;
cflb h:tf Jofkl/s kpf]hgsf]nflu ag]ejgdf sh Built Up Area sf]@) kl]tzt kfls{sf]
Joj :yf ug{kg5 .

lj sf; zln lř0df lgdf0f xg]; fj h]lgs ej g ; Da6wl lj z]f Joj :yf

o; pklf0df ; /sf/L, cw{; /sf/L, u}; /sf/L / ; fdlhs ; 3, ; :yfsf ejg, lj Bfno, c:ktfn, gl; € xř0,
:jf:Yo s0b,|tflnd s0b,| c6o xř0n, Jofkl/s kl]ti7fg cflb agfpg kf0g5 .

!= ..sł j u\$] ; fj h]lgs ejgsf]nflu 60td @ /f]kg / dfx8f @) ld6/ xg' kg]5 . vł j u\$]
; fj h]lgs ejgsf]nflu 60td ! /f]kg e6bf sd xg' x6g .

@= uf]p08 se/h]sf]xsdf lj le6g j u\$] ; fj h]lgs ejgsf]nflu lgDgfg; f/ Joj :yf ul/Psf]M-

- ..sł / ..vł j u\$]ejgsf]nflu clwstd uf]p08 se/h \$) kl]tzt; Dd lbg ; lsg5 .

- ..sł j u\$]nflu

h]lufsf]lř0km clwsQd kfpg]uf]p08 se/h

\$-)-) ; Dd &) kl]tzt

)-\$-)-) e6bf a9L)-*--)-) ; Dd ^) kl]tzt jf (%* j u{lkmbdW0]hg a9L x65

)-*--)-) e6bf a9L !-)-)-) ; Dd %) kl]tzt jf !^\$# j u{lkmbdW0]hg a9L x65

!-)-)-) e6bf a9L \$) kl]tzt jf @&#* j u{lkmbdW0]hg a9L x65

#= ..sł j u\$]ejgsf]nflu cfj Zostf cg; f/ /fVg ; lsg5 . ..vł j u\$]ejgsf]nflu clwsQd prf0{
!^ ld6/; Dd cgdlt lb0g5 / ..sł j u\$]nflu !)-& ld6/; Dd agfpg lb0g5 .

\$= ..sł j u\$] ejgsf] nflu cfj Zostf cg; f/ tNnf? /fVg ; lsg5 . ..vł j u\$] ejgsf] nflu
clwsQd % tNnf; Dd cgdlt lb0g5 ..sł j u\$]nflu clwsQd # tNnf; Dd agfpg lb0g5 .

%= ..sł j u\$] ejgsf] nflu dfq FAR sf] lgod nfu" xg5 . h; cg; f/ FAR clwsQd @ ; Dd
lb0g5 .

^= ..sł j u\$] ejgsf] nflu dfq af6f] tkm{nf06 kn9sf] lgod nfu" xg5 . af6f] tkm{afx\$ c6o
dfx8fd !^ ld6/sf]prf0{f0{a} nf0g dfgl nf06 kn9sf]lgod nfu" xg5 .

&= ejgsf]tNnfsf]prf0{cfj Zostf cg; f/ /fVg ; lsg5 . ; fj h]lgs ej gx? lgdf0f ubf{lDgfg; f/
; 7Jofs /fVg' kg5 .

*= ; 8s dfkb08 lgwf0f ePsf0f ; 8s dfkb08df yk @ ld6/ 5f8] agfpg' kg5 . ; 8s dfkb08
lgwf0f gePsf0f ..sł ..vł j u\$]ejgsf]nflu tlG ld6/ ..sł j u\$]ejgsf]nflu ! ld6/ 5f8y'
kg5 .

(= ..sl / ..vl ju\$[f] ejgsf] nflu # ld6/ /Vg' kg\$. t/ ..sl / ..vl ju\$[f] ejgsf] ; lj wf / Joj : yfkgsf] nflu agf0g] uf8{ xfp ; ; e46 Sj f6/ , lj B't ; a : 6zg, kDk xfp ; cflb Ps tNn) kfF ld6/e6bf xfrf] / @)) ju{ lkm6e6bf sd lkn6y Pl/of ePsf 6x/fx? / ..sl ju\$[f] c6o ; fj hlgS ejgsf] nflu hlufsf] ; dfgf ; Dd agfpg ; lsg\$.

!)= ..sl / ..vl ju\$[f] ; fj hlgS ejgsf] nflu # ld6/ /Vg' kgI . t/ ..sl / ..vl ju\$[f] ejgsf] ; lj wf / Joj : yfkgsf] nflu agf0g] uf8{ xfp ; ; e46 Sj f6/ , lj B't ; a : 6zg, kDk xfp ; cflb Ps tNn) kfF ld6/e6bf xfrf] / @)) ju{ lkm6e6bf sd lkn6y Pl/of ePsf 6x/fx? / ..sl ju\$[f] c6o ; fj hlgS ejgsf] nflu hlufsf] ; dfgfaf6 @ ld6/ 5f8l agfpg ; lsg\$.

!!= dh e4of^a tyf s/l8f] G6gtD rf8f0{!-% ld6/ -% lkm6_ xg' kb\$. e4of^asf] Tread sf] G6gtD rf8f0{!! 06rl / Riser sf] clwsQd prf0{& 0lGr xg' kg\$. ..sl / ..vl ju\$[f] ; ffj hlgS ejgsf] nflu G6gtD Ps j6f yk ; xfos e4of^a xg' kg\$. olb k|o\$ tNnfdF Floor Area @%)) ju{ lkm6e6bf a9L xg] / Travel Distance @% ld6/ e6bf a9g uPsf] cj : yfdf c6o ; fj hlgS ejgsf] xsdf klG G6gtD ! j6f yk ; xfos e4of^a xg' kg\$. To:tf ; xfos e4of^asf] rf8f0{ G6gtD ! ld6/ xg' kg[5 . %)) ju{ lkm6e6bf a9L lkn6y Pl/of ePsf ejgx?df ckt# tyf c ; Qm JoIQmx? ; d# e0#tNnf / zfrfnodf klG ; Sg] u/L Ramp sf] Joj : yf ug{ kg\$. ; f\$] rf8f0{ G6gtD ! ld6/ xg' kg[5 . Ramp agfpg !M) e6bf a9L : nfk /Vg' x6g .

!@= kfF tNnf e6bf a9L jf !^ ld6/e6bf a9L prf0{xg] ..sl ju\$[f] ejgx?sf] nflu pkoQm l8hf0g / :klj ; lkmS zgsf] lkn6sf] ; d# Joj : yf ug{ kg\$.

!#= ejgsf] ; Argfut ; /lffsf] ; fy ; fy} cfl:ds cj : yfdf kpfustf{x?sf] ; /lffdf ; d# k|tsh c ; / gkg] u/L lgdf0f ug{ kg\$. kpfustf{x?sf] cfl:ds ; /lffnf0{ b|6ut u/L e\$Dk lg/f]vs ; Argf l8hf0gsf] ; fy ; fy} Emergency Exit / Fire escape sf] ; d# Joj : yf ug{ kg\$. rnlrq , ; efejg h:tf dflg ; x? hd36 xg] ejgx?df cfktsfnlg l:yltsf] ; s# ug] o6qx? / cl6ulg/f]vs o6qx?sf] ; dl'rt Joj : yf xg' kg\$. o:tf ejgx?df cfktsfnlg dfu{ ; s#x? k|6 ?kdf b|vg] u/L /Vg' kg\$.

!\$= ..sl / ..vl ju\$[f] ; fj hlgS ejgx?sf] nflu kflsE lgDgfg' f/ xg' kg\$.

l ; gdf, cl86fl/od tyf To ; k\$[f/sf] c6o ejg - %) l ; 6sf] nflu !) ju{ld= gl ; ExfD / c:ktfn- % j\$[f] nflu !) ju{ld= ; /sf/L sf0fno / c6o ; 3 ; #yf ejg- !)) ju{ld= Built up Area sf] nflu !) ju{ld= dfnkf] , gfkL, a\$, 6#kms sf0fnosf] nflu - !)) ju{ld= Built up Area sf] nflu !% ju{ld= xg' kg\$.

c6o klj wfgx? # /fli60 ejg ; #tf (National Building code) df cfwl/t e0{g=kf-af6 tof/ ul/g] lgb|zsfdf tflsPsf] klj wfgx? ; d# k'ngf ug{ kg\$.

kgZr Mdfly pNnlvt afx\$ c6o klj wfgx? cfj f; lo ejgs}dfkb08 nfu" xg\$.

#= xl/t lfg #
o ; lfgdf ; Nnf3f/lsf] jg lfg xgd6t] vf]hf, rv' vf]hf / v:of^av' ; # vf]hfsf] dfkb08leqsf] lfgnf0{xl/t lfg egl tflsPsf] 5 .

s= gbl lsgf/ pklfq # xgd6t] vf]hf, rv' vf]hf / v:of^a v' ; # vf]hfsf] dfkb08leqsf] gbl lsgf/sf] rf8f0nf0{gbl lsgf/ pklfq egl tflsPsf\$. o ; pklfqdf s[lif kpf]hgsf] lqmfnsnfk dfq ug{ kf0g\$ / ; fdf6otf sg}sl ; dsf] lgdf0f ug{ kf0g] 5g . s[lif kpf]hgsf] nflu c: yfol k\$[tsf] 6x/f -ksf]rf_ agfpg

eg]cgdlit lbg ; lsg5 . gblaf6 vt/f ptkGg xg]ePdf gu/kflnsfsf]:jLs[t ln0{afw lgdfQf ug{lbg ; lsg5 .

v= jg pklfQ M o; pklfQ cftut ; Nnf3f/L jg lfQ kb5 . o; pklfQdf lglh kpf]hgsf]nflu sg}lsl; dsf] lgdfQf ug{lbg}5g . ; fj hlgS ; lj wf / kfs{Joj:yf cflbsf]nflu cfjZos ; Argfx? lgdfQf ug{k/Qf g=kf=sf]k} ; jLs[t ln0{a9ldf % ld6/ prf0{Ddsf]; Argf lgdfQf ug{ ; lsg5 .

emfn 9f5f jf e]6n6/ /fvG M cf^gf]hlufsf]; fy l; dfgdf 3/ agfpE ; fwof/sf]:jLs[t afx5 cG cj:yfdf emfn jf e]6n6/ jf sg}lsl; dsf]lgsf; sf]Joj:yf ug{kf0g}5g .

Sofl6n6/ jf jfbhL M 3/ agfpE ; fj hlgS ; 8s tyf ; 8saf6 tflsPsf]; 6Jofs; Dd Sofl6n6/, jfbhL, sf]f, ;]6ls kfgl 6sl tyf e-ofE agfpg kf0g}5g .

9n tyf kfglsf]lgsf; M krfxf] kfgl lgl/lfof dufn eP/ ; fj hlgS 9n jf ;]6l 6dfEdf hfB5'kg5 .

; ldf kvfh M ; ldf kvfh tyf ejgsf] hu cfkny} ; jfldJsf] hlufdf lgdfQf xg' kg5 . ; 8stkM cfjZos dfkb08 5f8L dfq ; ldf kvfh agfpg lb0g5 . ; fdfotof # ld6/eGbf clnf]kvfh lgdfQf ug{lbg}5g . ; f6Gbf clnf]kvfh cfjZos ePdf cflrto x/L g=kf=n]lj zlf :jLs[t lbg ; Sg5 .

3/ lgdfQf sfo{; Da6wl eQmk/ gu/kflnsfn]to u/\$f]dfkb08

eQmk/ gu/kflnsfsf lj leGg ; 8sx?nf0{-s_ b]v -r_ ; Ddsf]j u{56df0{lGdg dfkb08 sfod ul/Psf 5g\

; 8ssf]gfd / lj j /of

-s_ /fhdfu{M o; ; 8sdf s[b|/yfb]v bj }tkm{@% ld6/ ; Dd :yfol jf c:yfol lgdfQf sfo{ug{glbg]. != c/lgsf]/fhdfu{

-v_ ; xfos dfu{M s[b|/yfb]v bj }tkm{!% ld6/; Dd :yfol vfnsf]lgdfQf sfo{ug{glbg]. != gu/sf]; 8s @= uxO kf]y/L ln1/fB

-u_ lhNnf dfu{M s[b|/yfb]v bj }tkm{!! ld6/; Dd :yfol vfnsf]lgdfQf sfo{ug{glbg].

!= eQmk/ k'/fgf]af6f\$]l]tg sg]x5}; fgf]l7dl x5}l; gfdunsf]qnl; # -h8la6l sfofho ePsf]7fpE ; Dd .

@= eQmk/ -k'/fgf]af6f\$]l]tgsG] eQmk/ x5}gu/sf5 ; Dd .

#= eQmk/ dxfnldl :yfg b]v rfe'gf/fo0fsf]kflsE ; Dd .

\$= kl; vjh ; 8s

%= RofDxf l; * tfynl

^= ; Nnf3f/L -- k'/fgf]l7dl hfg]

-3_ sg\$6 ; 8s - kzfvf ; 8s _ M s[b|/yfb]v bj }tkm{& ld6/; Dd :yfol vfnsf]lgdfQf sfo{ug{glbg]

!= eQmk/ 6kl j ; :6k - ; b{lj gfossf]u5 ; Dd .

@= eQmk/ huft]x5}xgdGt]x5}gu/sf5 af6f]; Dd gofHlgdfQf ePsf]; 8s ; Ddf .

#= eQmk/ b/ ; #f/ sfof(hosf]klZrdtkm[s]sgf xE}cfBflus lf]sf]klZrd xE}gu/sf; ; 8s -
kf6L_ ; Dd .
\$= eQmk/ 6kl a; :6k b]v b/af/ :Sj fo/ hfg]lkr af6f]xgdGt]vfhfsf]kh; Dd .
%= dh9f\$ -- RofDxl; x
^= dh9f\$ -- ; 8fn
&= sdnkf]y/L klZrd l8n dglsf]af6f]5]paf6
*= rfE' hfg]af6f]
(= xgdfg 3f6 -- huftl
!)= Aof; L -- emfyjh
!!= OGbf0ofl -- Aof; L
!@= led; ; -- j f; Lsj f
!#= /fd3f6 -- 6kl kfs{
!\$= af/fxl -- c/lgsf]/fhdfu{
!%= efg -- uf}

-a_ lk8/ - ; xfos ; 8s _ M- s]b|/yfb]v b] }tkm(% ld6/; Dd :yfol vfnsf]lgdf sf{ug{glbg].
!= a]xfo0f -- sDkfs
@= xgdfg 3f6 -- gfnf
#= sdn lj gfos kf0k nf0g
\$= dh9f\$ -- 5fln^a
%= a]fn -- sf708f}
^= sdn lj gfos --h]uf Psls/0f cfof]hgf blf0fk]sf]af6f]
&= rfE' hfg]af6f]hf\$]sf]
*= dxfsfnl lk7 af6f]
(= oftf / vrf]af6f]
!)= j fl; srf af6f]
!!= sflxfrf af6f]
!@= /fd3f6 af6f]-- s
/fd3f6 af6f]-- v
!#= af/fxl af6f]-- u
!\$= xfskrf]xtl af6f]
!%= ; Nnf3f/L k/fgf]af6f]
!^= Aof; L af6f]-xfn dfnkf] sfof(ho cufl8_
!&= huftl k/fgf]af6f]
!*= 0{fbfjh af6f]

-r_ uf]f]af6f]
!= uf]f] / shf]-@)) dl6/ ; Dd nfd]sf]xsdf_ #
@= uf]f] / shf]-@)) dl6/efbf nfd]sf]xsdf_ %

; fj h]lgs ; 8s P; , @)#! adf]hd tf]sPsf]; 8s ; ldf

; fj h]lgs ; 8s P; , @)#! sf]bkrf # n]lbPsf]clwsf/ kof]u u/L >l g]kfn ; /sf/n]bxfosf]; fj h]lgs
; 8sx?nf0{b]xfoadf]hd alu\$/0f u/L ; 8ssf]s]b|/yfb]v bfofFafofFb]xfo adf]hdsf]; 8s ; ldf
tf]sPsf]5 .

-s_ /fhdfu? M

-!_ c/lgsf]/fhdfu{-sf7df08f}-sf]f/L_

lqej g /fhky
-v_ ; xfos dfu{

-!_ sf7df08f}-- lqzhl

-u_ lhNnf dfu{?

-!_ eQmk/ -- gu/sf
-@_ ; ftbfaf6f]-- l6sfe}j
-#_ ; fgfl7dl -- c/lgsf]/fhdfu{
-\$_ aflldtl -- uflfj /l
-%_ uf\$0f{-- ; f'f'
-^_ sf7df08f}-- blif0fsfnl
-&_ sf7df08f}-- a9flgns07
-*_ l; gfdEn -- eQmk/

-3_ zx/l dfu{?

gkfn clw/fHosf gu/kflnsf lfqlqs f ; a); 8sx? -/fhdfu{ ; xfos dfu{/ lhNnf dfu{j fx\$.

-!_ k\$/of -s_ df n]vPsf /fhdfu{/ pkTosfsf] rqnkysf] s]b|/yfb]v bfofFafofFbj]t/ kRrl;
kRrl; ld6/ ; 8s ; ldf tf]sPsf\$.
-@_ k\$/of -v_ df n]vPsf ; xfos /fhdfu\$] s]b|/yfb]v bfofFafofFbj]t/ kGw|kGw|ld6/ ; 8s
; ldf tf]sPsf\$.
-#_ k\$/of -u_ df n]vPsf lhNnf dfu\$] s]b|/yfb]v bfofFafofFbj]t/ bz bz ld6/ ; 8s ; ldf
tf]sPsf\$.
-\$_ k\$/of -3_ df n]vP adf]hd ; fj h]lgs ; 8ssf] Gogtd ! ld6/ / clwstd % ld6/ ; Ddsf]
k6kfy ; d]nf0{ ; 8s ; ldf tf]sPsf\$.
; fj h]lgs ; 8s Pq, @)#! sf]bkrf # s n]lbPsf]clwsf/ kpf]u u/L gkfn ; /sf/n]; 8s ; ldf
tf]sPsf\$; 8s ; ldf / ; 8s ; ldf gtf]sPsf]; fj h]lgs ; 8sdf ; f]; 8ssf]lsgf/faf6 ^-^
ld6/; Dd kvfn afx\$ c6o sg}lsl; dsf]:yfol agf6 -:6&r/_ jf ejg s; h]lgdf uf{gkfpq]
u/L lgif]v u/\$f]5 .

kl/R5ϕ %

ej.g dfkb08; # ; Dal6wt c6o dfkb08x?

kl/R5ϕ %

!= kzklt lfqsf]dfkb08

kzklt lfq lj sf; sf]f Pq, @)\$\$ sf]bkrf !) sf]pkbrf !)=!) / !)=!% lbPsf] clwsf/ kofu u/L kzklt lfq lj sf; sf]f ; #fns kl/ibn] agfPsf] bxf]o adf]hdsf] dfkb08nf0{gkfn ; /sf/af6 :jLs[t kkt ePsf]5 . kzklt lfqnf0{; #lft :df/s lfq elg kfrlg :df/s ; #lft Pq, @)!# cgtuf 3flift ePdf o; /L 3flift ePsf]ldit blv ; #lft :df/s lfqsf]nflu tf]sPsf]dfkb08 / kzklt lj sf; sf]f Pq @)\$\$ cgtuf agsf]dfkb08 nfu" xg5 .

!=! dfkb08 nfu" xg] lfqM of]dfkb08 kzklt lfq cgtufsf]bxfosf]7fpk?df nfu" xg5M

-s_ >l kzkltgy dlGb/ j l/kl/sf]bxfosf] lfq

- !_ k] {- lqej g lj dfg:yn
- @_ klZrd - ufzfnf rf\$blv ldqkfs{; Ddsf]rqmky
- #_ pQ/ - ldqkfsaf6 uf]L3f6 hfg]af6f]x6}afudtl gbl; Dd
- \$_ blifof - ufzfnf rf\$blv rqmky x6}lqej g lj dfg:ynsf]df6/ kfs{ Dd

-v_ hoj fuZj /L, tfdZj / tyf lgj fofZj /L j l/kl/sf]bxfosf] lfq

- !_ k] {- rqmky
- @_ klZrd - e08f/vfnsf] pQ/-klZrd sgaf6 l; kmn rp/ x6} sf=gkf= j 8f g+* sf]klZrd ; ldgf; Dd
- #_ pQ/ - l; kmnaf6 hoj fuZj /L cfpq]kSsl af6f]v pQ/ &% lds6/; Dd / hoj fuZj /L dlGb/sf]klZrdaf6 lgj fofZj /L blv pQ/ rqmky hf]8g]sRrl af6f].
- \$_ blifof - e08f/vfnsf]pQ/ tkf]sf]kvf6 .

-u_ e08f/vfnsf]bxfosf] lfq

- !_ k] {- rqmky
- @_ klZrd - e08f/vfnsf]kvf6 j flx/sf]sRrl af6f]
- #_ pQ/ - e08f/vfnsf]kvf6 j flx/sf]sRrl af6f]
- \$_ blifof - e08f/vfnsf]blifof-klZrd sgaf6 klZrd kl\$sf]6f]hsf]sRrl af6f]/ /ftfk]haf6 ufzfnf rf\$; Dd cfpq]kSsl af6f].

-3_ rf-lj xf/ tyf wGb]r]o j l/kl/sf]bxfosf] lfq

- !_ k] {- rqmky
- @_ klZrd - rfj lxn rf\$af6 nfd]kfy/L hfg]kSsl ; 8s
- #_ pQ/ - kzklt leq df=j= sf] blifof-k] { sgaf6 rGb]j gfos lg:sg] sRrl af6f] xb} rf-lj xf/ pQ/sf] af6 :tk ; Dd / Toxf]v pQ/ kSsl ; 8s lg:sg]sRrl af6f]; Dd .
- \$_ blifof - wGb]r]o kEofsf]blifof-k] {sgaf6 @) dl= blifof / rqmkyaf6 @) dl= klZrd u0{sRrl af6f]xb}rf-lj xf/ blifof tkf]af6 nfd]kfy/L hfg]kSsl ; 8s ; Dd .

-a_ rGbllj gfos j l/kl/sf]bxfosf] lfg

- !_ kJ { - rGbllj gfos dlGb/sf] pQ/ tk[fsf] rp/sf] kJ {pQ/sf] s9faf6 sRrlaf6f]xb}rfj lxn rf\$af6 nfdffkfy/L hfg]kSsl ; 8s ; Dd .
- @_ klZrd - rGbllj gfos dlGb/sf] pQ/tk[fsf] rp/sf] pQ/-klZrd s9faf6 ; fxl dlGb/sf]klZrdsf]kSsl ; 8s xB} ; f]dlGb/sf]kJ 9f6 nfdffkfy/L hfg] kSsl ; 8s ; Dd .
- #_ pQ/ - rGbllj gfos dlGb/sf]pQ/ tk[fsf]rp/sf]pQ/L ; ldfgf .
- \$_ blIf0f - rfj lxn rf\$af6 nfdffkfy/L hfg]kSsl ; 8s ; Dd .

-r_ e08f/7j / j l/kl/sf]bxfosf] lfg

- !_ kJ {- kSsl ; 8s
- @_ klZrd - wf]lvfhf
- #_ pQ/ - zxlB wd9Qm rf\$sf]pQ/ ; ldfgfaf^ e08f/7j / dlGb/sf]kE0fsf]pQ/L ; ldfgf xB}sf=d=g=kf= j 8f g=& ; l6 g=!)^&÷!! sf]ls=g=@ sf]hlufsf]pQ/L ; ldfgfb]v wf]lvfhf ; Dd .
- \$_ blIf0f - kSsl ; 8s / sfnf]kh .

-5_ s9j lxn kE0f j l/kl/sf]bxfosf] lfg

- !_ kJ {- s9j lxn hfg]af6f] / sf=d=g=kf= j 8f g=& ; l6 g=!)^&÷!! sf] ls=g=%* / ^! sf]hluf
- @_ klZrd - ; f] ; l6 g=!)^&÷!! sf]ls=g=# sf]hluf
- #_ pQ/ - ; f] ; l6 g=!)^&÷!! sf]ls=g=# sf]sxl efu / ; fxl ; l6 g=sf] ls=g^^ sf]hluf
- \$_ blIf0f - ; f] ; l6 g=!)^&÷!! sf]ls=g=^* / ls=g=&) sf]hluf .

!=@ kzklt lfgdf lgdff tyf c9o s9fsnfk ug{kf0gM kzklt lfgsf]wld\$, ; f:s[ts Pj -k/Dk/fsf] ; Af0f u/L ; f] lfgdf :j R5 j ftfj /of sfod /Vg cfj Zos ePsfh]kzklt lfgsf] dfkb08 nfu"ePsf] lfgdf s; h]klg bxfodf n]vPsf]dfkb08 lj kl/t sg}sf sf/j fxl ug{ u/fpg kfpg]59M

- s_ ejg lgdff ; DaGwl dfkb08M of] dfkb08 nfu" ePsf] lfgdf ejg agfp9f bxf0 adf]hd ug{k95M
- !_ ejg k/Dk/fut gkfnl z]hldf agfpg' kg5 .
- @_ gofFejg agfp9f sh hlufsf]*) kl|tzt efu ulp08 se/h lng ; lsg5 . t/ k/fgf] ejg eIsf0 ; f]7fPsf]k/}efudf gofFejg agfpg ; lsg5 . o; /L k/fgf]ejg eIsf0{ gofFejg agfp9f jf ; fxl ejg dd9 ubf{ ; flj ssf]ej gsf]gS; f clgj fo{?kn]kl/ib\ ; dlf k9 ug{k95 .
- #_ ejgsf] prf0n] kzklt lfgsf] jftfj /of, dlGb/, r]o, :tk jf laxf/nf0{ kl|tsh c; / gkg]ePdf a00n tnf ; lxt \$ tnf u/L a9ldf #% ktl6; Dd prf0\$]ejg agfpg :j ls[t lbg ; lsg5 .

t/ ejgsf] prf0h] kzklt lfqdf /x\$ f dlGb/, :tk cflb
j l/kl/sf] j ftfj /0fnf0{k|tsh c; / gkgIePdf ; 8s tkh k/fgf k/Dk/fut
gkfnl zhlstf ej g; # ldNg]u/L ej g agfpg :jls[t lbg ; lsg\$.

-\$_ ejgsf]l; ln^asf]Gogtd prf0{& kml6 ^ 0Gr / clwstd prf0{* kml6
xgkg\$.

-%_ snf tyf jf:t'snfsf b[6n] ; Af0f ugkgI k/Dk/fut gkfnl zhlstf /
/f0ffsfnl g ejgnf0{eTsf0{kgM lgdf0f ug{k/df jf ; f] ej g ddt ug{
k/df k/fgf]ej g cg; f/ xg]u/L gofFej g agfpg jf ddt ug{ ; lsg\$.
To:tf]ejgdf ; 8s tyf ; fj hlgS :yn tkh kfnl jf afbhl lgsfn\$]eP
gof+ej g lgdf0f ubf{v08 ^_ sf] clwgdf /xl kfnl jf afbhl lgsfNg
; lsg\$.

^_ ; fj hlgS :yn, af6f] gkl gS; fdf blvPsf]rf\$ cflb dfly kgIu/L SoflG6n\$, afbhl
cflb lgsfNg kf0g]5\$. bf}f]tnf blv dfly uf/f\$] ; tx eGbf j flx/ 3fd kfgl 5\$g]
kpf]hgsf]nflu a9ldf @ kml6 6k lgsfNg :jls[t lbg ; lsg\$.

-&_ cf/=; l=; l= / :6ln k]d :6&r/nf0{leq kl\$ kgI/ 06n]uf/f]5f]g]u/L ej g
agfpg :jls[t lbg ; lsg\$. ; f] afx\$ cf/=; l=; l= / :6ln k]d :6&r/
blvg]/ ejgsf]uf/fdf l; d06, rg cflb nufpg kf0g]5\$.

*_ emofn / 9f\$ tyf ltgsf vfkfx? k/Dk/fut gkfnl zhlstf sf7sf]agfpg'
kg\$. emofnsf]rf8f0{/ prf0\$]cgkft !M^{r=@} e0{Ps, ltg jf kfF dv]
/ rf8f0{@ blv # kml6 ; Ddsf]agfpg" kg\$. 5fgdf k/Dk/fut emofn
/Vg ; lsg\$.

t/ ejgdf kmfd]/flnE ; 6/ tyf sf]hk; an u\$ /Vg kf0g]5\$.

-(_ ejgdf lem6L, 6fon jf h:tf kpf]u ubf{jf 9nfg ubf{k/Dk/fut gkfnl
zhlstf b0{jf rf/ kfV]agfpg' kg\$. ; f]5fgf @% l8ul blv #% l8ul[sf]
:nflkdf xgkg\$. 5fgdf ; fwf jf snf]ds 68fn /Vg ; lsg\$.

t/ lgdf0f xg]ejgsf]tlgt/ c?sf]ejgn]3l/Psf]eP ; f]ejgsf]
; 8s kl\$ Pskfv]5fgf agfpg :jls[t lbg ; lsg\$.

-!)_ ejgsf] clGtd tnfd @% k|tzt ; Dd lfqkm a/fa/sf] sfzl agfpg
; lsg\$.

-!!_ cfkngf]hluf dfl kgIu/L ; fdfgotof t}f]tnfb]v sf7sf]afbhl agfpg
:jls[t lbg ; lsg\$.

-!@_ ejgsf]k|o\$ tnf 5l\$g]u/L uf/f\$] ; tx eGbf j flx/ a9ldf (0Grsf]
sf]gI lgsfNg ; lsg\$.

-!#_ cfkngf]hlufdf ej g; # ldNg]u/L Ps kml6 prf0{/ b0{kml6 rf8f0\$]k\$
agfpg ; lsg\$.

-!\$_ o; lfqdf a] d06 tyf ; d]a] d06 agfpg kf0g]5\$.

-!%_ ; 8s tyf ; fj hlgS :yn kl\$ 5f]8g]hlufdf kfgl 6df°, ; 6ls 6df°,
SoflG6n\$, j flx/L v8\$lnf cflb agfpg kf0g]5\$.

-!^_ ; fj hlgS 9nsf] ; lj wf gxg]k|o\$ ejgdf ; 6ls 6df° tyf ; f\$kl6sf]
Joj :yf clgjfo{?kn]ug{kg5 . ; 6ls 6df° tyf ; f\$kl6 agfpg cfkngf]
hlufsf] ; ldfgsf]sd]tldf Ps dl6/ leq kfg{kg\$.

-!&_ ; k] 9n gePsf]7fpdf cfkngf]hluf j flx/ krf]/ kfgl 5f\$g, cw/f]9ndf
xfp; sg\$zg ug{tyf gblfd 9n ld; fpg kf0g]5\$. 9n lgsf; sf]kf0k
; dt j flx/ gb]vg]u/L /Vg' kg\$.

- !*_ ; fj hlgS af6f]f sg}lsl; dsf]afwf xg]u/L ej g agfpg kf0g]5g . ; fy} wld\$ tyf ; f:s[ts ; Dkbf, zlnfkq Pj +kf6L kf]fsf] dfr8f g5]sg] / zrf] glaug]u/L ej g agfpg' kg5 .
- !(_ ej g agf]f ej gsf]u]p08 se/]hsf]sDtdf @% kl|tzt efudf xl/ofnl agfpg ?v lj ?]f nufpg' kg5 .
- @)_ k'/fgf ej gx? e]sf]f kl/ifb\$] :jLs[t lng' kg5 .
- @!_ o; l]df gof]ej g agf]f jf k'/fgf]ej g ddt ubf{gS; f :jLs[t u/fpg' kg5 . gS; f :jLs[t gu/f0{ jf gS; f a] / dfkb08 ljkl/t agf0Psf ej gx? e]sf0g5 .
- @@_ ej g lgdf]f ug]ej g agfpg :jLs[t lbg]; :yfa6 ej g lgdf]f sfo{k/f e} s]f]k]df0fkq lng' kg5 .

-v_ c6o s]fsnfk ug{ gkf0g] kzklt l]df :jR5 jftfj /0f sfod ug{ ; d] cfj Zos ePsf] of] dfkb08 nfu" ePsf] l]df s; h] klg b]fo adf]hdsf] sg} sfd sf/j f0{ug{u/fpg kfp]g}5g .

- !_ wld\$, ; f:s[ts, e]ts tyf c6o sg}lsl; dn]o; l]df] jftfj /0fnf0{ k]lft xg]sg}sf] ug{.
- @_ kl/ifb\$] :jLs[t ln0{ ; fgf-ltgf Joj ; fo ug{ jfx\$ jftfj /0fnf0{ k]lft xg]lsl; dsf]sg}sf/vfgf jf pB]sf]:ykgf tyf ; -rfng ug{.
- #_ k/Dk/fut ?kdf rln]cfPsf]khfsf]nflu jfx\$ dfbs kb]f]p]kfbg tyf lj qm lj t/0f ug{.
- \$_ gzfn' kb]f{ ; jg u/L jf gu/L 5f8f ?kn]; fj hlgS :yndf 3dlkm/ ug{ czf]glo sfo{ug{jf clzi6tf k]z] ug{.
- %_ JolQmut 3/, dlGb/ ; Qn, kf6L Pj +; fj hlgS :ynsf] kvf] c]l]df Jofj ; flos tyf /fhgllts nufot sg}klg lj ifosf]krf{ kDkn, th c]l] 6f:g jf 6f]g, gf/f n]g jf l]q]f ug{.
- ^_ ; 8s tyf k]ldf gfa]n]k; n nufot sg}klg Jofj ; flos sfo{ug{/ ; 8s 5]sf k; naf6 sj n jflx/ lgsfnl ; 8s 3]L kfnl lgsfnl k; n yfk .
- &_ kf6L, kf]f ; Qn c]l]df leq jf jflx/ kl/ifb\$] :jLs[t a] / sg}klg k]f/sf] k; n yfk jf Jofj ; flos sfd ug{.
- *_ ; 8s, k]L, af6f] dlGb/ k]E]f tyf ; fj hlgS :ynx?df lgdf]f ; fdul jf c6o j :tx? ykg{/ la:sg tyf nQfsk8f ; sfpg.
- (_ kl/ifb] tf]f] 7fp]f afx\$ c6o ; 8s, k]L, dlGb/ k]E]f, af6f] c]l]df a; L leff d]lg .
- !)_ ; fj hlgS af6f] gbl, s08, 3f6, jg, pkjg c]l]df lbzf lk; fa u/L km]f] d]f ug{jf blift agfpg .
- !!_ ; fj hlgS hluf, rf] c]l]df kl/ifb\$] :jLs[t gln0{kfn 6f] a:g tyf hfqf-kj \$f ; dodf ofqlx?nf0{c; ljwf xg] u/L lghl hlufdf klg sg} cj /f] v8f ug{.
- !@_ sfg]af/f ul7t sg}; fj hlgS sfo{ug]; :yfn]kl/ifb\$] :jLs[t ln0{sg} wd]fnf, kf6L, kf]f c]l]df agf0{jf ddt u/L ; fj hlgS sfdsf]nflu k]f] u/\$]f / kl/ifb] klz4 ; fw" ; Gt, dxGtx?nf0{ a:g Joj :yf ldnf0{ lbPsf] jfx\$ sg}klg wd]fnf, kf6L, kf]f ; Qn c]l]df kl/ifb\$] :jLs[t a] / ; ft lbg e]f a9L a:g .

- !#_ d; fg 3f6sf nflu kl/ifbñ] tf\$}f] 7fpæf bfp/fsf] Joj :yf ug{/ 0Gwgsf kof]hgsf nflu yf}kl/df0fdf laqm ug{j fx\$ Jofkfl/s b[6sf0fn] cllg pQ]hs kbyf{ UofF, k}ñ cflbsf]; #o / lj qml lj t/Of ug{.
- !\$_ kl/ifbñ]:jLs[t gln0{Jofkfl/s b[6sf0faf6 lel8of]jf r nlrq k}z} ug{ tyf 5fofs}g ug{.
- !%_ l; d06, 58, 06, h:tfkftf cflb lgdf0f ; fdullsf]k; n /fVg .
- !^_ kl/ifbñ]tf\$}f] 7fpæf j fx\$ cGo 7fpæf 3DtL jf :yfol t/sf/L k; n /fVg .
- !&_ df0/, df0/; f0\$ n cflbsf]ddf ug] Hof; n, ulln jf a]8LE ; Da6wl pBf]u / ; Mln jf sf7 lrg]d}lg kof]u u/L kmg{/ agfpg]pBf]u ; #fng ug{.
- !*_ sv/f, xf+, afv], e}L, a# / cflb k]Ng]pBf]u ; #fng ug{.
- !(_ sg}Jofj ; flos kof]hgsf]nflu ! km6 e6f a9lsf]; s} k6l /fVg'.
- @)_ wfld\$ sfo\$] nflu kl/ifbñ] :jLs[t lbPsf0f j fx\$ JolQmut kof]hgsf nflu gbl, 3f6, jg jf pkjgaf6 afnjf, df6f] 9Ef cflb len\$g .
- @!_ gbl, 3f6, s08 cflbdf ; fagn]gxfpg, nuf wg, ef8f dfeng, pmg wg, lgsf; hf}y jf kmNg, k]nt'kzk65lnf0{cfxfn a; fpg jf gxfpg, km}xf] ug{ gbl 3f6 jf s08sf]lsgf/fsf]df6f]vGg, sf}g{ zj jf l; gf]k}of\$g, df5f dfg{ kfgl tfGg]kDk nufpg, gbl psf; df v}L ug{jf :yfol jf c:yfol lgdf0f sfo{ug{/ gbl, 3f6 jf s08sf]lsgf/fdf hyfefjL cfuf] afNg .
- @@_ jg jf pkjgdf ?v lj?jf pv]g, sf6y, 9fNg, xfuf l5dNg, efRg, kft-kltE/ lgsfNg, h8la6l ; sng ug{ kmk}ñ l6kg, k]nt'kz' r/fpg tyf 5f8f 5f8y, vfN8f]vGg, k; n yfk, ; ef ; Dd]g jf gfrufg ug{/ 7hf]:j/df /]8of] 6kl/s8{ ahfpg, v}L ug{ :yfol jf c:yfol lgdf0f sfo{ ug{ wfld\$, ; f:s[ts k/Dk/fdf j fx\$ kl/ifbñ]:jLs[t a] / e] et} vfg, of]uf; g afx\$sf Jofofd ug{ kl/ifbñ]tf]s]bPsf]7fp+j fx\$ cGoq zj uf8y tyf zj uf8}f 7fpæf ; dflw agfpg .
- @#_ d7, dlGb/, kf6l, kf}f, ; Qn cflb laufg{ e]sfpg / hyfefjL cfuf]afNg, lsnf 7f\$g, u0}f agfpg .
- @\$_ ; fj h]gs pkof]usf wf/f, 0gf/, zf}fno, 9n aQL cflbnf0{laufg{ b?kof]u ug{ k}l}ft ug{ aQLsf]ckJoo ug{ hyfefjL lgsf; 5f8y / 9n lgsf; aGb ug{.
- @%_ k/Dk/f cg; f/ khf u/L ef]u lb0{cfPsf0f j fx\$ sg}klg kzk}l]sf]aw ug{tyf df5f-df; 'cflbsf]lj qml lj t/Of ug{.
- @^_ k]nt'kzk}lnf0{; fj h]gs ?kdf 5f8f 5f8y .
- @&_ jGo kzk}lnf0{dfg{j dfg]r}6f ug{.
- @*_ tf; , h}f cflb v]g tyf v}hpg .
- @(_ kzklt lf}leq ; gftgb]v dflg cfPsf wd{lj kl/tsf sg}lqmf]snfkx? ug{.

!#=# ; /sf/L, cw{/sf/L tyf u} ; /sf/L ; } ; :yfx?n]of]dfkb08 nfu"ePsf]lf]df af6f] 9n, lahhL, 6]nk}f cflb h:tf]lgdf0fsf sfo}md ; ~rfng ug{ cl3 kl/ifbñ]:jLs[t lng'kg} .

!=\$_ v08 @ sf]pkv08 -s_ / -v_ df hg; s}s/f n]vPsf]ePtf klg kzklt lf}sf] ; j}gzlntf Pj +k/ftf]j s, wfld\$ tyf ; f:s[ts dxTj nf0{; Af0f Pj +; Da4g ug{kl/ifbñ]sg}lf]df lgdf0f sfo{nufot cGo sg}lqmf]snfkx? ug{lgif]v ug{

; Sg\$. s; h]dfkb08 lj kl/t tyf kl/ib\$sf]:jls[t a\ / sg}sfu u/\df To:tf] JolQm jf ; :yfnf0{kl/ibn]kzklt lf\ lj sf; sfif Pq, @)\$\$ adf]hd ; hfo ug{ tyf krlnt sfgg adf]hd ; hfo ug\$]nflu ; DalGwt lgsfodf n\l k7fpg ; Sg\$.

!-= of]dfkb08df n]vP hlt s/fdf o; }dfkb08 adf]hd / of]dfkb08 nfu"gePsf] kzklt lf\sf]cGo 7fpdf / of]dfkb08df pNn\ gePsf cGo s/fx?df sf7df08f] gu/ lj sf; ; ldltsf]ejg lgdf\ ; DaGwL dfkb08 adf]hd xg]u/L kl/ibn]ejg lgdf\ ug{:jls[t lbg ; Sg\$.

@= lj B't lgodfj nL / 5f8g' kg]b/L

@!= sg}klg ejg lj B't k|f/of jf lj B't lj t/of nf0gsf tf/x?af6 lj B't lgodfj nL @)%) cg; f/ gkfn lj B't k|lws/ofn] tf\$]sf] b/L 5f8l dfq lgdf\ ug{kfpq\$.

@=@ @%)÷\$\$) ef]6h b]v !! xhf/ lj B't ef]6 ; Ddsf] gfE]tf/sf] 5paf6 sldtdf !=@% dl= / !! xhf/ e6bdfyl b]v #,)) lj B't ef]6sf] tf/ 5paf6 sldtdf @ ld6/ 5f8 dfq lgdf\ ug{kf0g\$.

Ij B't Vp@)\$(sf]bkmf @) n]lbPsf]clwsf/ kpf]u u/L tof/ kfl/Psf]Ij B't lgodfj nl @)%)

!= e06]v lahhlsf]tf/; Dd xgkg{Gogtd b/L M

-!_ Ij B't Ij t/Of tyf k| f/Of kQffnlsf]Ij leGg efl]6sf]Ij B't tf/ tyf e0\$]alrdf /xg] b/L cg"; rL !@ df n]vPsf]eGbf sd xgx]b].

-@_ ; 8s dfly tyf ; 8ssf] 5p]df Ij B't nf0g n]hfg' k/df pkoQm kfl] lws b[i6sf]Qf ck]g0{n]hfg' kg].

-#_ ##,))) efl]6 eGbf a9L efl]6sf]nf0g n]hfg' cfj Zos ePdf cg"; rL !@ df pNn]vt ##,))) efl]6sf] nflu tf]sPsf]Gogtd b/Ldf k]o\$ ##,))) efl]6sf]nflu yk)=#)% Id6/sf]b/Ldf n]hfg' k5{.

@= ; 8ssf]j f/kf/ Ij B't nf0g n]hfg]; DaGwdfM 3gfj :tL ePsf] 7fp]f !!,))) efl]6 eGbf a9L lfdtfsf]Ij B't nf0g ; 8ssf]j f/kf/ ug]kbf{8j n 0G; h6/ kQffnlsf]kpf]u ug] kg].

#= Ij B't nf0gsf]bfof-afof-xg' kg]{km/sM

-!_ Ij B't k| f/Of tyf Ij t/Ofsf]nf0g n]hfg' kb{3/ jf ?vaf6 cg"; rL !# df pNn]vt b/L eGbf sd b/Ldf n]hfg' x]b].

-@_ ##,))) efl]6 eGbf a9L efl]6sf]nf0g n]hfg' cfj Zos ePdf cg"; rL !# df pNn]vt ##,))) efl]6sf]nflu tf]sPsf]Gogtd b/Ldf k]o\$ ##,))) efl]6sf]nflu)=#)% Id6/ yk u/L n]hfg' kg].

\$= Ij B't n6Xfx?sf] alrdf xgkg]{ km/sM -!_ Ij B't n6Xfx?sf] Ps csf] alrsf] b/L sfod ubf{lahhlsf]tf/sf]clGtd G; f0n :6y, knofS6/ ckm ; kn]L tyf e0af6 tf/; Dd xg]b/L ; d] larf/ u/L n6Xf uf8g' kg].

%= 3/ dflyaf6 lahhL nf0g n]hfg' g]xg]M 3/ dflyaf6 sg]lsl; dsf]Ij B't nf0g n]hfg' x]b].

t/ Uof/h, 6x/f jf kvf]n dflyaf6 Ij B't nf0g n]hfg' cfj Zos k/df \$))-@#) efl]6 ; Ddsf]nf0g n]hfg' ; lsg]. o; /L nluPsf]Ij B't nf0g Uof/h, 6x/f jf kvf]n]sf] ; a]Gbf clnf]7fp]af6 sl]tdf # Id6/sf]b/Ldf kg]{u/L n]hfg' kg].

^= Pp6}n6Xfaf6 Ij leGg efl]6]hsf]nf0g n]hfg]; DaGwdfM

-!_ Pp6}n6Xfaf6 Ij leGg efl]6]hsf]nf0gx? n]hfbf xf0{efl]6]hsf]nf0g dflyaf6 / nf] efl]6]hsf]nf0g tna]f6 h8fg u/L n]hfg' kg].

-@_ pklgod -!_ adf]hd nf0g h8fg ePsf]df nf]efl]6]hsf]tf/df xf0{efl]6]hsf]tf/af6 sg}k\$]f/sf]lns]h jf c]o sg]lsl; daf6 vt/f jf rfh{xg gkfp]g}u/L h8fg ug] kg].

-#_ xf0{efl]6]h tyf nf]efl]6]hsf]tf/sf]alrdf kfl] lws b[i6sf]fn]/xg' kg]{km/s sfod ug]{kg].

&= lj B't nf0g / 6lnkrfg nf0g ghlsaf6 nhfg]; DaGwdfM lj B't nf0gsf]ghlsaf6
6lnkrfg nf0g jf 6lnkrfg nf0gsf]ghlsaf6 lj B't nf0g nhfg' k/df cgdltkq kfk
JolQm tyf ; DaGwt b/; #f/ lgsfo alr cfk; df 5nkm u/L lj B't jf 6lnkrfg nf0gnf0{
kflj lws b[6sf0faf6 afwf jf rfh{gxg]u/L nhfg"kg5 .

*= cfsfz lahhlaf6 arfj 6M cgdltkq kfk(JolQm]; xfpbf]7fpK?df cfsfz lahhlaf6
xg]gf\$; fgl / lj B't zI0msf] 36a9 xg glbgsf]nflu cfsfz lahhl /lfs oGq jf c?
; xfpbf]; fwgsf]Joj :yf u/L pQm ; fwgx?af6 cfsfz lahhlsf]kpfhg xg]Joj :yf ; dt
ug{kg5 .

(= lj B't pTkfbg, k} f/Of tyf lj t/Of ; DaGwl lgdf0f :ynsf]j /lk/ 3/hluf kpfu
ug{lgifw ug{; Sg]M

-!_ Pgsf]bkrf ## sf]pkbkrf -#_ sf]kpfhg]nflu lj B'tsf]pTkfbg, k} f/Of jf lj t/Of
; DaGwl sg}lgdf0f sfo{ePsf0f To:tf]lgdf0f sfo{ePsf]7fp+j f ; f]7fpsf]j /lk/Lsf]
lgIzrt b/L leq kg{3/ hluf c? s; h]sg}vf; sdfs]lgldQ kpfu ug{gkfp]u/L
gkfn ; /sf/n]; do ; dodf gkfn /fhkqdf ; hgf k\$flzt u/L lgifw ug{; Sg5 .

-@_ lj B't k} f/Of jf lj t/Of ug\$]nflu h8fg u/\$f]lj B't nf0g dgl tyf To:tf]nf0gsf]
bf0f j f0f cg; rL !@ / !# df pNn]vt b/L leq 3/ agfpg jf ?v /flg x5g .

cg; rL - !@
 -lgod \$* ; # ; DalGwt _

tf/ b]v e0{ Dd xg' kg]Gogtd b/L				
qm; +	lj B't efl]6]hsf]:t/	; 8S j f/	; 8ssf]5p - ld6/ _	cGo :yfgdf - ld6/ _
!=	@#).\$)) eGbf dfly !!,))) eGbf sd	kf/ ubf{ - ld6/ _	%=%	\$=^
@=	!!,)))) / ; f]eGbf dfly ##,)))) ; Dd	^=!	%=*	%=@

cg; lr - !#
 - lgod %) ; # ; DalGwt _
 tf/ b]v 3/ j f ?v; Dd xg' kg]Gogtd b/L

qm; +	lj B't efl]6sf]:t/	3/ tyf ?vaf6 xg]Gogtd b/L
!=	@#)÷\$)) b]v !!,)))) ; Dd	!=@% ld6/
@=	!!,)))) eGbf dfly b]v ##,)))) ; Dd	@=) ld6/

b]6Jo M pk/fQm Gogtd b/L sfod ubf{xfj fsf]rfkn]pTkGg xg] tf/sf]pRrtd dRof0{- DofIS; dd l8^n\$; g_
 ; d]sf]lx; fa ug{kge .

#= kōkōn kDk ; DaIGw gkfn cfon Igudsf]dfkb08

-s_ ; fwf/Of lj qñtf, KofS8 lj qñtf / dIStñ lj t/s e0{kōkōnod kbfy{ljqml lj t/Of ug{cfj Zos Gogtd hUufsf]lfqkmn

\$=! = dxfgu/kfInsf lfq leqM

-s_ k|tflj t ljqml :yn /fVg]hUufsf]; 8s tk{sf]dfx8f 36ldf !* ld6/ e0{sh hUufsf]lfqkmn 36ldf !@ cfgf xg' kgf .

-v_ k|tflj t ljqml :yn /fVg]hUufsf]bj }tkñ -dVo ; 8ssf]; #}csf]; xfos ; 8s -hf]8Psf]; 8s ePsf]cj :yfdf dVo ; 8s tk{sf]dfx8f 36ldf !\$ ld6/ e0{sh hUufsf]lfqkmn 36ldf * cfgf xg' kgf .

\$=@ = pk-dxfgu/kfInsf lfq leqM
k|tflj t ljqml :yn /fVg]hUufsf]; 8s tk{sf]dfx8f 36ldf @) ld6/ e0{sh hUufsf]lfqkmn 36ldf Ps /fkgl -8P sYf_ xg' kgf .

\$=#-gu/kfInsf lfq leqM
k|tflj t ljqml :yn /fVg]hUufsf]; 8s tk{sf]dfx8f 36ldf #) ld6/ e0{sh hUufsf]lfqkmn 36ldf 8P /fkgl -; j fb0{sYf_ xg' kgf .

\$=\$= uf=lj =; = lfq leqM
k|tflj t ljqml :yn /fVg]hUufsf]dfx8fdf ; xh}bfxf]f]ef/L ; j f/L ; fwg cfj t hfj t ug{; Sg] sDtldf ufe]hoQm ; 8s ePsf]xg}kgI/ ; 8s tk{sf]dfx8f #) ld6/ e0{sh hUufsf]lfqkmn 36ldf @ /fkgl -tlgsYf_ xg' kgf .

\$=%= sg} klg /fli6@ /fhdfudf -dfyl pNn]vt jlu\$/Of leq gkgI lfq k|tflj t ljqml:yn /fVg]hUufsf]/fhdfu{tk{sf]dfx8f \$) ld6/ e0{sh hUufsf]lfqkmn 36ldf c9f0{ /fkgl -kq]rf/ sYf_ xg' kgf . /fli6@ /fhdfudf kgI dxfgu/kfInsf=pk dxfgu/kfInsf=gu/kfInsfdf k|tflj t ljqml:y nsf] nflu qmdzM dfly bkmf !, @ / # df pNny eP adf]hdsf]hUufsf]lfqkmn / dfx8f xg' kgf .

\$ ^= olb ; fwf/Of lj qñtf, KofS8 lj qñtf / dIStñ lj t/ssf] ljqml:yn dh ; 8s; # ghf]8Psf]ePdf dh ; 8s; # ljqml:yn /xg]hUuf hf]8g]kj z dfu{bfxf] ; j f/L rNg ; Sg]e]hldgsf]lfqkmnsf]xsdf pk/fQm cg; f/ xgkgf .

\$&= gofF IgoIQm xg] KofS8 lj qñtf, dIStñ lj t/ssf] xsdf ljqml:y nsf] hldgsf] lfqkmn / dfx8f ; fwf/Of lj qñtf adf]hd g}xgkgf .

\$ *= dIStñ lj qñtfsf] xsdf cfkngf] ljqml:yn ; 8s l; dfgf s6f0{kof]t ; Wofdf 8@ jf s66g/ /fVg ; lsg]sf]f jf 5\$}hldg xg' kgf .

\$ (= bu@ lfqsf]xsdf To; lfqdf cfj Zos kōkōnod kbfy\$]cfklt{Pj +lj qñtf IgoIQm ; DaGwdf Igudsf]Joj :yfkgn]tf\$]adf]hd xg' kgf .

gr^M ; fwf/Of tyf kofS8 lj qntfsf] k|tflj t lj qml:ynsf] lfgkm gkfn ; /sf/sf]
; DalGwt lgsfon] tf\$ \$f] ; 8s ; ldfgfaf6 5f\$g' kgI b/L s6f0{ vb lj qntfn]
lglj} fb kofu ug{; Sg] lfgkm xg' kg\$.

\$=!)=; fwf/Of lj qntfsf]lj qml :yndf xgkgIef]ts k] fwf/x?M

- s_ lj qml:ynsf] sDkfp08sf] Itg tkrl ; xfp0f] sDkfp08 jfn jf kSsl krl; L^a -
sf8]f/n] 3] \$f] u/L ; 8s tkrl sf] dfx8df -/fhdfu0f /x\$] lj qml:yn hg
kfoM @\$ 306f vNnf /x65 _ 36ldf ^ ld6/sf] kj z tyf ^ ld6/sf] lgsf; af/
xg' kg\$.
- v_ lj qml:ynsf] sDkfp08sf] kDkof8{ nuftf/ ; fj hlgS ; 8s ; ldfgf blv kDkof8{
; Ddsf] Pkrl /f\$ sf] k0d06 ANofs 6k cyjf kSsl lj \$ cg Ph lkr^a
ul/Psf] xg' kg\$.
- u_ lj qml :yndf ; ; sfp06/ ; :6f] ?d, uf8?d, 6] f0n0 0Toflb kSsl lgdf0f u/L
; j :Yo lkpg] kfglsf] wf/f jf t/f0{ lfgdf 60aj hsf] Joj :yf xgkg\$.
- 3_ lj qml:yndf jiff0df ; j f/L ; fwgdf 06wg ebf{ cfsfz] kfglaf6 xg; Sg]
lfltnf0{ dWogh/ /fvl kDkof8df kDk tyf 06wg egI ; j f/L ; fwg ; d] 9fSg]
:6ln :6&r/ ; \$sf] Joj :yf ePsf] xg' kg\$.
- a_ lj qml:ynsf] sDkfp08df clgl ; /lffsf] nflu 36ldf rf/ yfg !) s]hl=
lfdtfsf] l8=k=; L= kifo/ PS6L^a Uj L; / /Vg' kg\$.
- r_ lj qml:ynsf] sDkfp08 leq Pkrl /f\$, 6] krfd{ ; ; sfp06/; kfls0 PI/of
afx\$; j f/L ; fwg cfj t hfj tdf afw gkgI :yfgdf jftfj /of ; Af0f ugI
; bfj xf/ xNsf lsl; dsf] j [ff/fk0f ug{kg\$.
- 5_ lj qml:yn sDkfp08 leqsf] ; krl ; j f6/sf] plrt 80] hsf] Joj :yf u/\$f] xg'
kg\$.
- h_ lj qml:yn sDkfp08 leq kof(t sDkfp08 nf0l6^a -ek/ nf06_ sf] Joj :yf
u/\$f] xgkg\$.
- em_ sxl 6f9fsf] b/Laf6 :ki6 blvg] u/L 36ldf @) lkm6 clnf] \$ lkm6 8fold6/sf]
bj } krl lgudsf] nflu] ; lxtsf] 36ldf Pp6f xfl] 80j f\${/ /Vg' kg\$.

gr0M k|tflj t ; a} lfgsf lj qml:ynsf] Gogtd xgkgI ef]ts k] fwf/ x?sf]
hldgsf] cufl8 -; 8s tkrl sf] dfx8f Pj +lfgkm tfl]sP adfl]nds} xgkgI /
c6o ef]ts ; Argf hlufsf] cfsf/ k\$ / cg; f/ ldnf0{ lgdf0f ug{; lsg\$.

\$=! !=kofS8 lj qntfsf] nflu lj qml:yndf xgkgI ef]ts k] fwf/x?

- s_ lj qml:ynsf] sDkfp08sf] tlgtkrl ; fwf/Of krl; LE xgkgI.
- v_ ; fj hlgS ; 8s ; ldfgf blv lj qml:yn ; Ddsf] Pkrl /f\$ t/f00f sd; \$d
lj \$ cgPh lkr^a xgkgI kxf8df 9Efsf] kofu ug{; lsg\$.
- u_ lj qml:yndf ; ; sfp06/ / lkpg] kfgl Joj :yf xg' kg\$.
- 3_ lj qml:ynsf] sDkfp08df clgl ; /lffsf] nflu sDtdf Psyfg !) s]hl= sf]
l8=; l=kl= kifo/ PS; 6L^a Uj L; / /Vg' kg\$.
- a_ lj qml:yndf jftfj /of ; Af0fsf] nflu ; bfj xf/ xNsf lsl; dsf] j [ff/fk0f ug{kgI

-v_ ; 8s 5p df kōh kDk (**Fueling Station**) h8fg jf :yfkgr ubf{ckgfpgr' kgI
dfkb08sf zt?M
p2Zom

of] dfkb08sf] dhe't p2Zo kōh kDk kōfū ugI uf8lx?af6 dh ; 8sdf rNg]
oftfoftnf0{xg ; Sg] x:tlfk (**Interference**) nf0{oyf; Dej Goğ ugI / ; 8s
; /lfnf0{clwstd Wofg lb0{; Deflj t ; j f/L b36gfnf0{Goğ ugI /x\$} 5 . ctM
dfkb08sf] ; kmn sfof{ogsf] nflu gkfn cfon lgudn] sg} JolOm jf ; :yfnf0{
x/\$ k\$/\$f ; 8s 5p df kōh kDk h8fg ug{cgdlt kq (**License**) kōfg ug{
cl3 k}tlj t :yn kflj lws bl6sf0faf6 pkoOm 5 jf 5ğ ; f]af/] ; 8s ljefu jf
cgtu\$sf sfofnoaf6 lnvt ; xdtl lng' kg5 .

dfkb08sf zt?M

- != ; fdfGotM ; 8ssf] Ps lsgf/f tkh b0j 6f kōh kDkx?sf] b/L sldtdf #)) dl= xg'
kg5 .
- @= ; fdfGotM Ps :yndf Pp6f e6bf a9L kōh kDk /Vg glbg] tfklg olb sg}
sf/Ofj ; b0{jf b0E6bf a9L kōh kDkx? glhs glhs Ps}:yndf :yfkgr ug{
k/df Itglx?nf0{5\$5\$}kj z dfu{pknAw gu/f0{pkoOm r\$fo\$}Ps ; dfgfGt/
; Jf dfu{(**Service Road**) sf] lgdf0f u/L P\$oj 4 ?kdf /Vg' kg5 / o:tf] ; Jf
dfu{lgdf0f ubf{nflg]vr{; DalGwt kōh kDk wglx?n] Joxfg{kg5 .
- #= kōh nod kbfi{eg{hfg]jf lg:sg]uf8lx?n]dh ; 8sdf rln/x\$} c6o uf8lx?sf]
; fdfGo axfj nf0{x:tlfk gu/f] \eGg]p2Zonf0{Wofgd /fvL sg}Ps ; 8ssf]bj }
lsgf/f tkh **Staggered** ?kdf kōh kDk :yfkgr xg]u/L dfq ; xdtl lb0g]5 .
- \$= ; 8s 5p kōh kDk :yfkgr ug{ cfj Zos kgI k'f\$ / lj sf; ug{ ; DalGwt
lgsfonf0{ ; xofū k%ofpg] p2Zon] gofF lgdf0f xg] ; 8ssf] xsdf lj :tf
0lghlgol/a l8hf0g ugI avtdf g}sx\$F/ s; /L kōh kDk nufot c6o ; Jfx?
cfj 4 u/L :yfkgr ug{ ; lsg5, oslg u/L /Vg ; DalGwt ; 8s of]hgfn]Wofg lbg'
kg5 .
- %= sg}klg ; 8s rf\$ (**Junction**) df kōh kDk /Vg lb0g] 5ğ . dVo dVo
; 8sx?sf]rf\$ k/df j:tl rf\$ blv kōh kDk /xg]:ynsf]b/L sldtdf klg !))
dl= /xg' kg5 t/ dVo ; 8s / ; fgj zfvf ; 8s ; - ; fgj zfvf ; 8s eGgn]
h; sf]rf\$0{% dl= e6bf sd 5 To:tf] ; 8snf0{hgfpgr]5_ rf\$ k/df kōh kDk
/xg]b/L o:tf]rf\$ blv sldtdf \$) dl= ; Dd xg ; Sg5 .
- ^= cfjf; lo lfg, k/ftllj s lfg, :df/s :yndf kōh kDk /Vg lb0g] 5ğ / kōh
kDk /xg]:yn; Dd hfg]; 8ssf]rf\$0{sldtdf %-% dl= xg' kg5 . dxfgu/kflnsf,
gu/kflnsf, gu/ lj sf; ; ldltx?n]cfjf; lo lfg]sf]JofVof ug5 .
- &= ; 8ssf] **Longitudinal Gradient** oyfzSo ; dtn ePsf]:yfgdf dfq kōh kDk
/Vg lb0g]5 tfklg kxf8L lfgdf o:tf]; 8ssf] **Gradient** % kl'tzt e6bf dfly
ePdf To:tf]:yfgdf kōh kDk /xg]hluf ; dtn ?kdf lj sf; ug{kgI/ kōh
egI:yfgdf kfgl hdg glbg ! kl'tzt ; Dd **Crossfall** kōfg u/L ; f]hlufaf6

glhssf]gnldf kfgl v:g]JoJ :yf ldnfpg' kg\$. k\$ kDksf]cfj t hfj t xg] lfg dh ; 8ssf]; tx cg; f/ g}xg' kg\$.

*= k\$ nod kbfi{eg{k\$ kDk kofu ug]uf8lx?sf]cfj fudg ; /lft Pj +; ud /fVg dh ; 8saf6 leq k:g jf lg:sg ; xh agf]6sf]kj z tyf jflx/ cfpG] df\$? (**Curves**) xg' kg\$. o:tf]xgsf]nflu k\$ kDk /xg]hluufs]df\$ /fhdfu\$]xsf]slDtdf \$) dl6/ xg'kg[/ dVo dVo zx/L ; 8sdf slDtdf #) dl6/ /xg' kg\$. dfly h]s}elgPtfklg sg}zx/L ; 8s hxFCtoflws ; jf/L rfsf]sf/Ofn]7hf vfnf 6sx? kj z ug{/f\$ nufOPsf]5 To:tf]:yfgdf k\$ kDk /fVg dfu u/df hluufs]df\$ slDtdf @@ dl6/ ; Dd xg' kg\$.

(= k\$ kDk lfg leq kfnkfnf] k\$ nod kbfi{eg{ cfpG] jf hfg] uf8lx?nf0{ cfjZos :yfg (**Space**) kbfg ug{k\$ kDk /xg]-c6o ; }f ; lj wf h:t}uf8L ; le{ a, xjf eg]cfib ; dfj z gePsf] hluufs] ; f0h /fhdfu\$]xsf]slDtdf \$) dl6/ x !% dl6/ / dVo zx/L ; 8ssf]xsf]slDtdf #) dl6/ x !% dl6/ xg' kg\$. sxl zx/L ; 8s hxFC7hf 6s jf a; x?sf]kj z lgiw ul/Psf]5 To:tf]:yfgdf hluufs] ; f0h slDtdf klG @@ dl6/ x !% dl6/ xg' kg\$.

!)= k\$ kDk lfgnf0{dh ; 8saf6 cnlu}/fVg Pp6f slDtdf !@ dl6/ nfd]/ @ dl6/ rf\$ **Buffer Strip** lgdf\$ ug{kg\$ / **Buffer Strip** dfyl slDtdf # dl6/ prf0\$]k\$ kDk lg; fgl lrgx -hf]Pp6f vDafdf /xg\$ jfx\$ c6o sg}k\$/sf :6&r/x? tyf lj 1fkg kf6lx? /fVg kf0g]5\$. **Buffer Strip** sf]jflx/L lsgf/f ; 8s ; ldfgf tflsPsf]; 8s eP ; 8s ; ldfgdf / To:tf]l; dfgf gtf]sPsf]zx/L ; 8s jf c6o sg}k\$/sf]; 8s eP k\$ kfy jflx/ gfnlsf]jflx/L nf0g kl5 ; #} /xg' kg\$. **Buffer Strip** sf]j l/k/L !%) dl=dl= sf] **High Kerbs** agfpg' kg\$ h; n]ubf{uf8lx? **Buffer Strip** df hfg g kfcf] \ ^) ; dl= e6bf clnf]sg}klg la?j f, k\$ x? **Buffer Strip** j l/k/L nufpg kf0g]5\$.

!!= k\$ kDk kofu ug{ cfpG] jf aflx/ lg:sg] uf8lx? dh ; 8sdf cfj fudg ul//x\$; jf/lx?n]k]olf blvg]xg' kg\$. tuf/f] (**Check Barrier**) tyf ; jf/L cfP uPsf]k]6 gblvg]7hf df\$? -**Sharp Bends**_ glhs}k\$ kDk /fVg lb0g] 5\$.

!@= dh ; 8saf6 k\$ kDk cfpG hfgsf]nflu lgdf\$ ul/Psf kj z af6\$]df\$? ; ldtfs]bl]6sf]fn]#) dl6/ cw]of; sf]xg' kg]ePtf klG ol df\$? -**Curves**_ sf]!# dl6/ e6bf sd cw]of; df 36f0{agfpg sg}xfntdf cgdlt lb0g]5\$.

!#= k\$ kDksf]sofno tyf df]an cfib e08f/ ug{lgdf\$ ul/g]3/ / **Toilet** cfib kDk blv slDtdf \$ dl6/ b/Ldf xg' kg\$.

!\$= k\$ eg]kDk ; 8s l; dfgf tflsPsf]; 8s eP ; 8s l; dfgf blv jf ; 8s l; dfgf gtf]sPsf]; 8s eP gfnlsf]aflx/L lsgf/f blv slDtdf ^ dl6/ b/Ldf /fVg' kg\$.

!%= k\$ kDk kofu ug{ cfpG] hfg]uf8lx?nf0{lgb}z ug{**Entry** / **Exit** lrgx kf6lx? /fVg' kg\$.

!^= j iff6fddf k6h kDk leqsf]kfgl l; w}; 8sdf allg lb0g] 5g . o:tf] xg glbg
k6h kDk leq pko0m gfnl k0ffnlsf]lgdfof u/L ; 8s 5p /x\$]gfnldf ld; fpg'
kg5 . o:sf ; fy}dh ; 8ssf] 5p df lgdfof ul/Psf]gfnl k/L k6h kDknf0{kj z
dfu{vflg lb0g] 5g / o:tf] /f\$g kDkjfnfn] cf^gf] vr6f6 To:tf] gfnl dfly
pko0m ; f0hsf]sNe6{lgdfof ug{kg}5 .

!&= obl k6h kDkjfnfn]xNsf ; jf/L ; fwgsf]nflu dfq k6h kDk h8fg ug{xf]eg]
l; ldt hUufdf klg k6h kDksf]cuf8lsf]dfx8f sIDtdf klg !% dl6/ xg' kg5 /
Buffer Strip -!) dl= x # dl= sf] tyf Entry / Exit af6f] sIDtdf klg ^ dl=
rf8f0{xg' kg5 / df8x? #) dl6/ cw{of; sf] xg' kg}ePtf klg sIDtdf !#
dl6/sf]xg' kg5.

!*= dfkb08sf zt{x? lak/Lt /fhdfu{ ; xfos /fhdfu{ zx/L dfu{jf c6o ; 8s 5p df
sg}klg k6h kDk :yfkf ePdf hg; s}avtdf klg lagf ; r'gf ; 8s lj efu4f/f
eIsf0g]jf x6f0g] 5 / To; /L eIsfpg jf x6fpg nflu] vr\$] ; Dk0f{/sd
; /f\$]jfnf Jol0mjf ; #yaf6 e/f0{Ing ; lsg]5 .

!(= lgDg sfofnox?sf]kl|tlglwTj xg]u/L Ps cgludg ; ldt u7g ul/g5 h; n]p0m
sfo\$] sfof]ogdf ; do ; dodf cgludg, dNofEg / gofFk6h kDk rfn"ug]
; Da6wL -**Commission_** l; kmf/; ug5 .

kl|tlglwM

gkfn cfon lgudsf]sfofho ; of]hs
; 8s lj efusf]sfofho ; b:o
dxfgu/kflnsf÷gu/kflnsf÷
gu/ lj sf; ; ldt]sf]sfofho ; b:o
ufpAj sf; ; ldt]sf]sfofho ; b:o

l; gdf xnsf ; Da6wdf rnlrq ; Da6wL dfkb08

\$= l; gdf xnsf ; Da6wdf rnlrq -lgdfof, k6z6 tyf lj t/of_ lgodfj nl

@)\$^E df ePsf]Joj :yf

\$!= rnlrq k6z6 Ohfhtkq kfpgh]kfnug ug{kgtztM

rnlrq k6z6 ug]Ohfhtkq k|t Jol0m]bxfosf zt{x? kfnug ug{kg5M

\$=!!=rnlrq k6z6 ugnf0{rnlrq hfF ; ldtaf6 hfF u/f0{:jLs[t InP/ dfq
k6z6 ug].

\$!=@=rnlrq 3/df lgwf{/t ul/Psf]l; 6e6bf a9L l; 6 /fvL rnlrq gb]fpg]

\$!=#=Ohfhtkqdf lgwf{0f ul/Psf]:yfg jfx\$ c6o :yfgdf rnlrq k6z6 gug].

\$!==\$=cfj f; lo ej gdf ; fj hlgS k6z6 gug].

\$!=%=lj t/s jf lgdftaf6 dfq rnlrq InP/ k6z6 ug].

\$!=^=Ps rnlrq ejgsf]nflu as ePsf]rnlrq csf]rnlrq ejgdf kþzǵ
ubf{; Dal6wt lj t/s jf lgdf{fsf]:jls[t gln0{kþzǵ gug].
\$!=&=lel8of]rnlrq kþz\$sn]lgdf{faf6 skl/f06 u/\$f]gkfnl rnlrq dfq
kþzǵ ug].
\$!=*=rnlrq kþzǵ, lgdf{f / lj t/0f ; Da6wdf gkfn ; /sf/, ; ~rf/ d6qfnoáf/f
ahf-ahfdf lbPsf]lgbzgsf]kfngf ug].

\$@= rnlrq 3/df xgkg]Joj :yfm

-s_klxnf]t/sf]rnlrq 3/df bxf0 adf]hd Joj :yf xg' kg5 .

!= cf7; o e6bf a9l bz\$ j :g]l; 6
@= l; gdf:sfk b\fpq]vfnsf]d08k, :qmgj fn / kbf{
#= k]o\$; o l; 6sf]nflu rf/j 6f lk; fa v08 -ol/gn_ Ps lbzf v08 -dlxfn
tyf k?ifsf]nflu 5\$5\$}
\$= bz\$ a:g]; a}>0flsf]:yfgdf szg
%= sd; \$d bzj 6f df/sf/ kfs{ug]:yfg
^= df/sf/; f0sn / ; f0sn kfs{ug{kof{t :yfg
&= dflyNnf]/ tNnf]>0flsf]nflu 5\$5\$}; lj wfoQm l6s6 lj qml ug]Joj :yf
*= bz\$ / kþzǵ kbf\$]alr sDtldf al; km6sf]b/L
(= rnlrq kþzǵdf j fwf gkg]vfnsf kof{t kj záf/f / cfsl:ds áf/x?
!)= 9n lgsf; sf]/fdf]Joj :yf
!!= kRrl; kltzt bz\$x? c6fpg]kltlffno
!@= 5\$}rdgf uxsf]Joj :yf
!#= l; 6sf]cgkftdf cllg lgo6q0f ; fwgx?
!\$= Wjgl :ki6 / /fdf] # ; Gg ; lsg]kþzǵ slf
!%= kfylds lrlst; ssf]Joj :yf

-v_bf]f]t/sf rnlrq 3/df bxf0 adf]hdsf]Joj :yf xgkg5M

!= kfF; o Ps b]v cf7; o ; Dd bz\$ a:g]l; 6
@= l; gdf:sfk b\fpq]vfnsf]d08k, :qmgj fn / kbf{
#= k]o\$ Ps; o l; 6sf]nflu rf/j 6f blng kwfx?
\$= k]o\$ Ps; o l; 6sf]nflu rf/j 6f lk; fa v08 / Pp6f lbzf v08 -dlxfn
tyf k?ifsf]nflu 5\$5\$}
%= bz\$ a:g]t}f]>0fl j fx\$ c6o >0flsf]:yfgdf szg
^= l6s6 lj qml ug]; lj wfoQm :yfg
&= ; f0sn, df/sf/; f0sn, df/sf/sf]nflu kfls{sf]Joj :yf
*= kof{t ; wofdf kj záf/x? / cfsl:ds áf/x?
(= l; 6sf]cgkftdf cllg lgo6q0f ; fwgx?
!)= Wjgl :ki6 / /fdf] # ; Gg ; lsg]kþzǵ slf
!!= bz\$ / kþzǵ kbf\$]alr sDtldf j ffx lkm6sf]b/L

-u_lel8of]rnlrq 3/df bxf0 adf]hdsf]Joj :yf xgkg5M

!= 36ldf Ps ; ob]v a9ldf ; ft; o ; Dd bz\$ a:g]l; 6
@= jfn:qmgdf rnlrq b\fpq]Joj :yf

#= kTos ; o l; 6sf]nflu rf/j 6f blng kwfx?, t/ ; fdfGotM j ifel/g} 708f
 tfkqmd ePsf :yfgx?df cfj Zos gxg]
 \$= kTos ; o l; 6sf]nflu rf/j 6f lk; fa v08 / Pp6f lb; f v08 -dlxnf tyf
 k?ifx?sf]nflu 5\$5\$}
 %= bz\$ a:g]kyd >0fldf / ; f]eGbf dflysf]l; 6df szg
 ^= kfls{sf]JoJ :yf t/ ; j f/L ; fwg gePsf :yfgdf cfj Zos gxg]
 &= l6s6 aRg ; lj wfoQm :yfg
 *= kof{t ; Wofdf kj zaf/x? / cfsI:ds af/x?
 (= l; 6sf]cgkftdf clUg lgoGof ; fwg
 != Wj gl :ki6 / /fdf]; Gg ; Sg]kPzG sIf
 !!= bz\$ / kPzG kbfsf]alr sDtldf bz lkm6sf]b7L
 !@= gkfnl rnlrq dfq b7fpg kfpq]

pNnlvt adf]hd l; kmf/; kfk t ePKI5 ; ~rf/ dGqfnon]To:tf] rnlrq 3/sf] :t/
 tf\$L rnlrq kPzG ug{:j ls[t lbg' kg\$.

%= ; @Qm ; fdlxs / ofhgfa4 cfj f; ; DaGWL dfkb08
 - gkfn /fhkq efu \$ ldt)^@.!!.@@ df k\$flzt _
 -s_ eflts ofhgf tyf cfj f; ; DaGWL M-

!= gkfn ; /sf/ j f lghl lqaf6 ofhgfa4 cfj f; tyf hluf lj sf; sfoqmd sfof]og ubf{sf7df8f}-
 pkTosfsf]gu/kflnsf lqdf lghl cfj f; lo kPfhgsf]nflu 38]lsf]clwstd lqkm @ /fkgl,

@= ; @Qm cfj f; (**Apartment Housing**), ; fdlxs cfj f; (**Group Housing**) / cfj f; of]lo
 38]lsf] lj sf; (**Residential Plot Development**) ug{ ofhgfa4 cgdlt (**Planning
 Permit**) lbBf ; DalGwt lgsfon]e-pkofu / k' fvf/ lfdtfsf] cfwf/df ; /n / ; ud k]qmf
 ckgfpg]

#= ; @Qm cfj f; , ; fdlxs cfj f; tyf ofhgfa4 cfj f; lo lq; Dd eflts k' fvf/ lj sf; ug{: DalGwt
 lgsfox? -; 8s, vfgkfgl, b7; ~rf/, lj B't, :yfglo lgsfo cflb_ n]kfyldstf lbg]

\$= ; a}gu/kflnsf tyf .sl ju\$ uf lq lj sf; ; ldtx?n]zx/L lqnf0{sDtldf j :tl lj sf; lq /
 j :tl lj sf; lgif]wt lq df jul\$/of u/L tlj j if{leq e-pkofu gS; f tof/ ug]

%= j :tl lj sf; lgif]wt lqdf s]lfhGo, jGohGo, dgf]GhghGo cflb sfof? ug{dfq cgdlt lbg]/
 ; f]lqdf ; /sf/L / cw{/sf/L ; yfaf6 zx/L k' fvf/df nufgl ug{kfyldstf glbg]

^= ; @Qm cfj f; , ; fdlxs cfj f; / ofhgfa4 cfj f; lo lqdf lsQf Psls/of ug{/ lj sl; t 38]L
 cg' f/ lsQf ldnfg ug{sfof df dfnkf] sfof]o / gfl zfvn]cfj Zos sfo{ug]

-v_ ; @Qm cfj f; (**Apartment Housing**); fdlxs cfj f; (**Group Housing**) ofhgfa4
cgdlt (Planning Permit) ; DaGWL k]qmf M-

!= ; @Qm cfj f; , ; fdlxs cfj f; cfofhgf ; ~rfng ug]JolQm ; 3 ; yf j f sDkglN]bxfosf]s/f vhf0{
 ; DalGwt :yflgo lgsfodf ofhgfa4 cgdlt]sf]nflu lgj lbg lbg' kg\$ / :yflgo lgsfosf]cg/f]vdf gu/
 lj sf; ; ldt u7g ePsf] 7fPdf gu/ lj sf; ; ldtaf6 / gu/ lj sf; ; ldt u7g gePsf] :yfgdf
 ; DalGwt zx/L lj sf; tyf ejg lqdf 18lehg sfof]oaf6 ofhgfa4 cgdlt lb0g\$ M

-s_ ofhgf:yn j l/kl/sf]ef]ts k' fvf/x? vNg]u/L !M\$))) :shsf]nf\$zg Knfg,
 -v_ lkmN8df ePsf ; DkOf{lgdfQfx? b]vg]u/L ofhgf :ynsf]gfkL gS; f / lkmN8df gfkL ul/Psf]-Knq
 6phaf6_ !M))) :shsf]; e]gS; f,
 -u_ ofhgf:yndf lsQf lj efhgsf]!M%) :shsf]Ans Knfg,
 ; f]Ans Knfgsf]gS; fdf b]fo adf]hd xg' kg\$ M-
 -c_ ofhgf:yndf kj z dfu{/ cGo dfu\$] rf\$fo{v08 u= df t]sPsf] dfkb08
 cg; f/ xg' kg\$.
 -cf_ kn6sf]; f0h Gogtd)-@-@-) -*) ju{ld6/_ / dfx8f ^ ld6/ rf\$fo{/Vg' kg\$.
 -0_ vNnf lfg ofhgf:ynsf] sh lfgkmsf] Gogtd # kl'tzt / nDaf0{jf rf\$fo{
 Gogtd * ld6/ xgkg\$.

-3_ af6f] 9n lgsf; , knxf] dhf Joj :yfkG, vfgkfgL ; fdbfos lfg cflbsf] ljj/of vhf0Psf]
 !M%) :shsf]gS; f,
 -a_ ofhgf:yndf lgdfQf ul/g] ejgx?n] 9flsPsf] lfgkmm ki6 vhf0Psf] !M))) :shsf] uf]p08
 se/h gS; f,
 -r_ ofhgf:yndf lgdfQf ul/g]ejgx?sf]k]to\$ tNnfsf]!M%) :shsf]^nf] Knfg .
 t/ !) -bz_ cfjf; 0sf0{Dd /xg]; eOm cfjf; ejg lgdfQf ug\$]nflu ofhgf cgdlt lng
 cfj Zos kg\$5g .

@= v08 ! adf]hd ljj/of kz ul/Psf]#% lbgLeq ofhgf cgdlt lbg' kg\$. ; f]c]lwleq cgdlt lbg g; lsg]
 cj :yf eP ; f\$]sf/of ; lxtsf]hfgsf/L lgj Dsnf0{lbg' kg\$. ofhgf cgdlt cj lw @ j if\$]xg\$. @ j if{
 leq cgdlt kfP adf]hd lj sf; lgdfQf z? gu/df cgdlt gjls/of u/fpg' kg\$.

#= v08 ! adf]hd k/\$]lgj dg ; DaGwdf dfu adf]hd ofhgf cgdlt lb6f hluufsf] :j fld]sf]af/df s]kmtdf
 vhf0{cgdlt lbg ; lsg\$. t/ lgdfQf ug{cl3 ofhgf :ynsf ; DkOf{hluufx? ; /sf/L, P]hfgL, kl{hluuf ePdf
 ; flj ssf]lfgkmsf] g36g]u/L To:tf hluufx? Plss/of u/L lsQf ldnfg ug; lsg\$.

\$= ofhgf:yn leq ; /sf/L, P]hfgL, kl{hluuf ePdf ; flj ssf]lfgkmsf] g36g]u/L To:tf hluufx? Plss/of u/L
 lsQf ldnfg ug; lsg\$.

%= ofhgf cgdlt cg?k lgdfQf jf lj sf; ug\$]nflu lgdfQf :jLst ; DalGwt :yfglo lgsfoaf6 lngkg\$ /
 lgdfQfstf]f]fli60 ejg ; lxtf kOf{?kn]kfg ng ug{kg\$.

-u_ ; eOm cfjf; ejg (Apartment Housing) lgdfQf ; DaGwl dfkb08 M-

; eOm cfjf; ejg lgdfQf ; DaGwl dfkb08 b]fo adf]hd xg\$ M-

!= ; eOm cfjf; :yn; # hfl]8g]kj z dfu\$]Gogtd rf\$fo{ \$ cfjf; 0sf0{Ddsf]nflu Gogtd \$ ld6/, !)
 cfjf; 0sf0{Ddsf]nflu \$=% ld6/, %) cfjf; 0sf0{Ddsf]nflu ^ ld6/, %) cfjf; 0sf0{e6f a9lsf]
 nflu * ld6/ xg' kg\$ / ofhgf:ynleq cGo dfu(df sn 8]:ofs af6f\$]nDaf0{clwstd !)) ld6/ xg'
 kg\$. sn 8]:ofs l; wf af6f]df dfq /Vg kf0g\$. uf8L 3dfpg]:yfg (x{ ld6/sf]j uf\$]/ jf j Qfsf/
 lfg /Vg' kg\$. b0{; 8ssf]0G6/; \$; g se\$]/l]8o; Gogtd ; 8s rf\$fo\$]cfwf xg' kg\$.

@= clwstd uf]p08 se/h (Ground Coverage) %) kl'tzt xg' kg\$.

#= clwstd ^nf] Pl/of cgkft (Floor Area Ratio - FAR) k'/fg]zx/L lfg afx\$]sf]cGo lfgdf # xg' kg\$
 . k'/fg]zx/L lfgdf k/Dk/fut jf:t'snf sfod /Vg]u/L ; DalGwt gu/ lj sf; ; ldlt jf gu/kflnsfn]
 t]s]sbP adf]hd FAR xg\$.

\$= Gogtd vNnf lfg cGtu e-; tx vhf /Vg\$]xsf @) k|tzt xg' kg\$ / cGo vhf efus]xsf #)
k|tzt xg' kg\$. e-; tx vNnf /Vg] lfgdf xl/ofnl au]fsf]?kdf kofu ug{; lsg\$. t/ hldg dgl
kfgl hfg]dfu{9fSg kf0g]5g .

%= Gogtd ; Jofs cf^gf]:j fldTj sf]hldgsf]; ldfgaf6 5f8gkg]b/l b]fo adf]hd xg' kg\$ M
sf7df8f]pkTosfdf cuf8L ^ ld6/, k5f8L \$ ld6/ / bf6f af6f \$ ld6/ .
cf^gf] tkm\$]; Jofs -s_ , csf] tkm\$]; Jofs -s_ / ejg; # hf]8Psf]; 8ssf] rf8f0{-v_ sf]
ofukmnf0{b0{u0ff ubf{k|t xg]cs e6f a9L prf0{-u_ sf]ejg lgdf0f ug{kf0g]5g . h:t}M u = @
x -s+ v+ s'_

^= b0{Anssf]alrsf]Gogtd b/l ^ ld6/ xg' kg\$.

&= Gogtd kfs\$:ynsf]xsf *) ju{ld6/ jf ; f]e6f 7hf] lfgkmm ePsf]cfjf; 0sf0\$]nflu ! sf/, @
df0/; f0sn / @ ; f0snsf]kfs\$ ug]; lj wf / *) ju{ld6/ e6f ; fg] lfgkmm ePsf]kto\$ \$ -rf/_
cfjf; 0sf0\$]nflu ! sf/, \$ df0/; f0sn / \$; f0snsf]kfs\$ ug]; lj wf xg' kg\$.

gf M

-s_ ; Dk0f{18hf0g tyf cGo ; lj wfsf]Joj :yf /fli60 ejg ; lxtf cg?k xg' kg\$.

-v_ e0{tNnf, j} d06, ; |dj} d06 cfj fl; o kof]hgsf]nflu ge0{:6f], Jofofdznf, kfs\$ tyf cGo ; lj wfx?
h:t}ln^6 j h, 0n]S6sn ?d, kfgl 6df6L cflbsf]kof]hgsf]nflu ePdf To:tf]kof]hgsf]nflu pkofu
ul/Psf]e0{tNnf, j} d06, ; |dj} d06 tyf 5fgf dfly lgdf0f xg]ln^6sf] d]zg sf]f, kfgl 6df6L
cflbn]cf]u6\$]lfgkmm FAR df u0fg ul/g]5g .

-u_ ; 0Qm cfjf; sf]dfkb08 nfu" xg' e6f cuf8 alg; s\$f ejgx?sf]pkofu kl/jtg ug{rfxg\$]k|tfj
dfly pNny ePsf]dfkb08; # ldNg]ePdf ; 0Qm cfjf; ; -rfng ug{cgdlit lbg ; lsg\$.

cg; lrx?

tNnfsf]prf0{

lgodfj nl

; fj hlgS ej gsf]tNnfsf]clwstd prf0{@=&) dl6/ -(km6_ xG5 .

AofVofM

@=&) dl6/ -(km6_ sf] prf0{eGgn] Ps tNnfsf] e0{
b]v csf[tNnfsf]e0{; Dd dfGgk5{. e0{b]v l; lnE ; Ddsf]prf0{
; b} (km6 eGb f sd xg'k5{. (lkm6 clwstd prf0{xf]/ tNnfsf]
k'/f agfj 6 ; d] o; df ; dfj z xG5 .

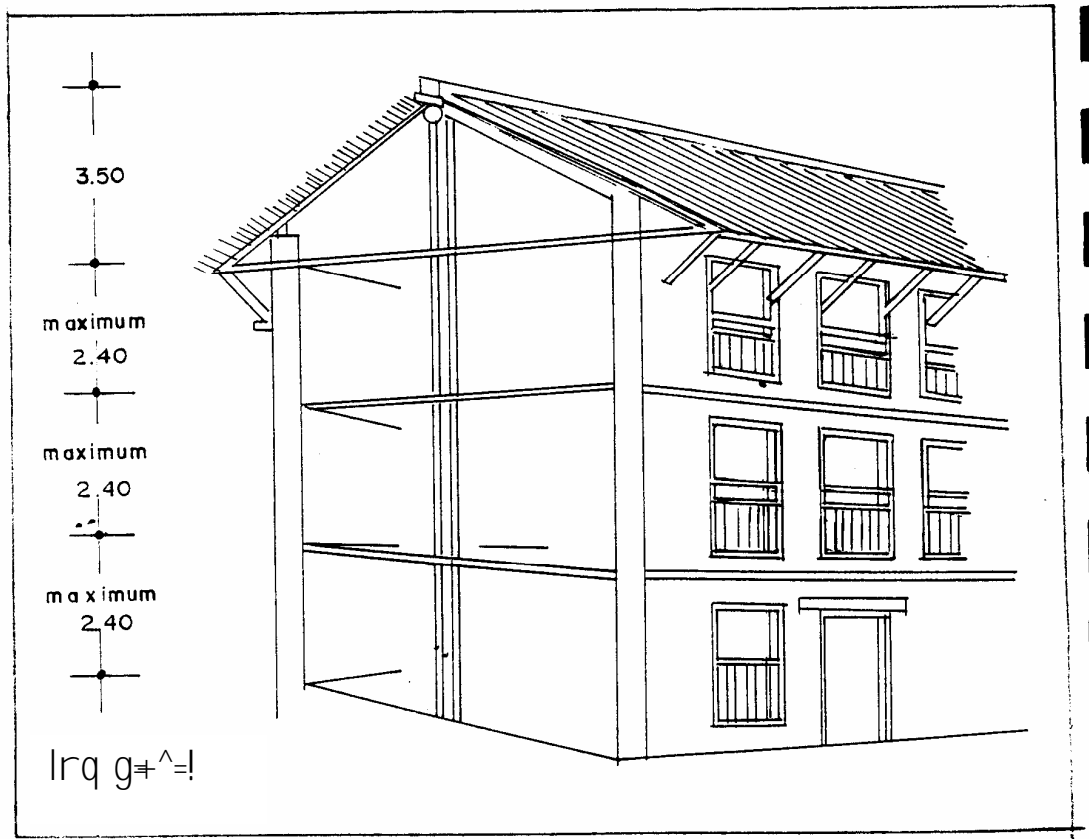

ej gsf]tNnf; Vof

lgodfj nLM

; Aift :df/s pklf]df ; fwf/oftof \$ tNnf / 5fgf ; d]t
u/L #% lkm6 prf0{Dd agfpg cgdlt lb0g] 5 t/ bfof+jfof+

:df/sx? ePdf ; f] :df/sx?nf0{k|tsh c; / kg[u/L 3/ agfpg
cgdlit lb0g] 5g . ; f] :df/snf0{k|tsh c; / gkg[u/L :df/ssf]
prf0{eGbf sd c|nf]u/L 3/ jf ejg agfpg cgdlit lb0g] 5 . #
tyf \$ tNn]3/x?sf]nf0gdf /x\$fvfnL hlufdf agf0g]gof+3/sf]
nflu clwstd \$ tNn]/ a9ldf #% lkm6 ; Ddsf]prf0\$]3/ agfpg
lb0g]5 .

JofVof

pbfx/0f-!M

#0 tyf \$Æ tNn] 3/x?sf] nf0gdf /x\$fvfnL hlufdf
agf0g] gofF3/sf] nflu cgdlit lb0g] clwstd tNnf \$0 xg5 .
; drf jftfj/0fsf]; Af0fsf]nflu gofF3/ agfpBf lj Bdfg 3/x?sf]
tNnf ; Vof / 5fgfsf]cfsf/ tyf zhl; # ldn\$]xgk5{.

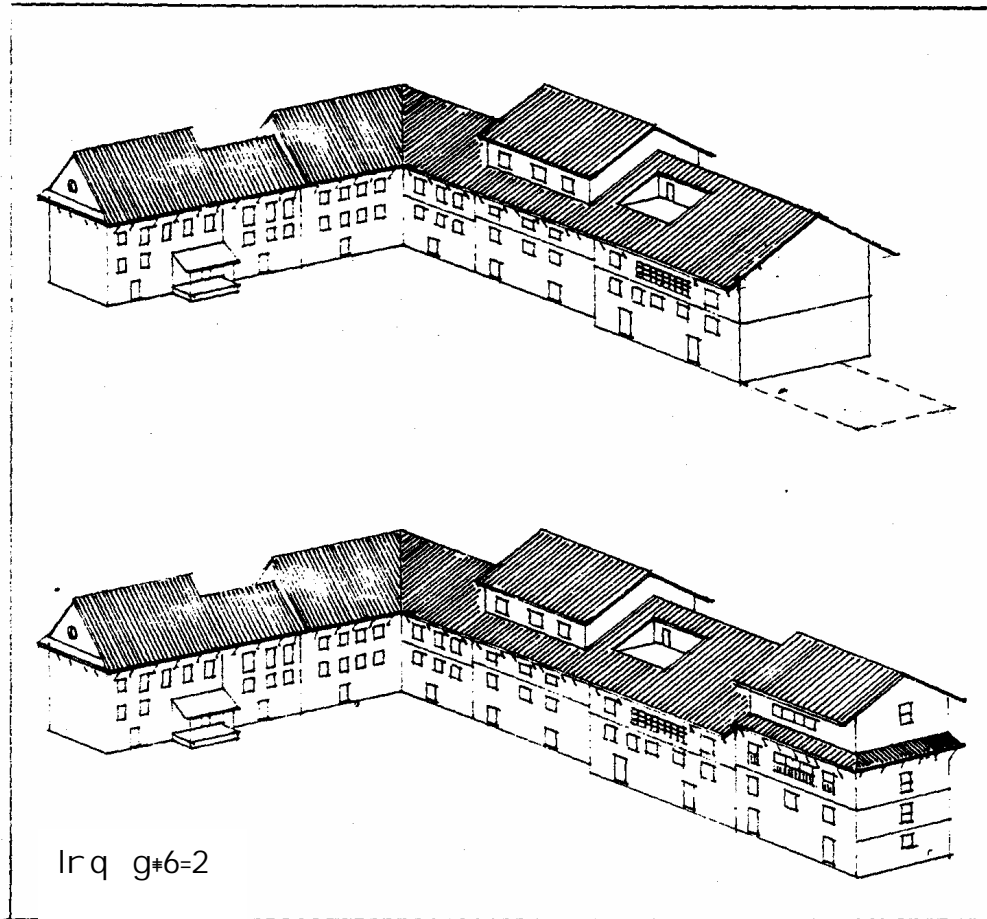

ej gsf] tNnf ; Vof

pbfx/0f- @

; ñlg /yflrq cg" f/M

#, #!÷@ tyf \$ tNn] 3/x?sf alrdf vfnL hUuf k/}sf]

5 . vfnL hUufsf] nx/df lj Bdfg ePsf 3/x?sf] k/Dk/fut
cfsf/nf0{; Af0f ug{/yf lraqdf b}yf0P em}goffej g j 9ldf \$ tNn]
xg ; S5 .

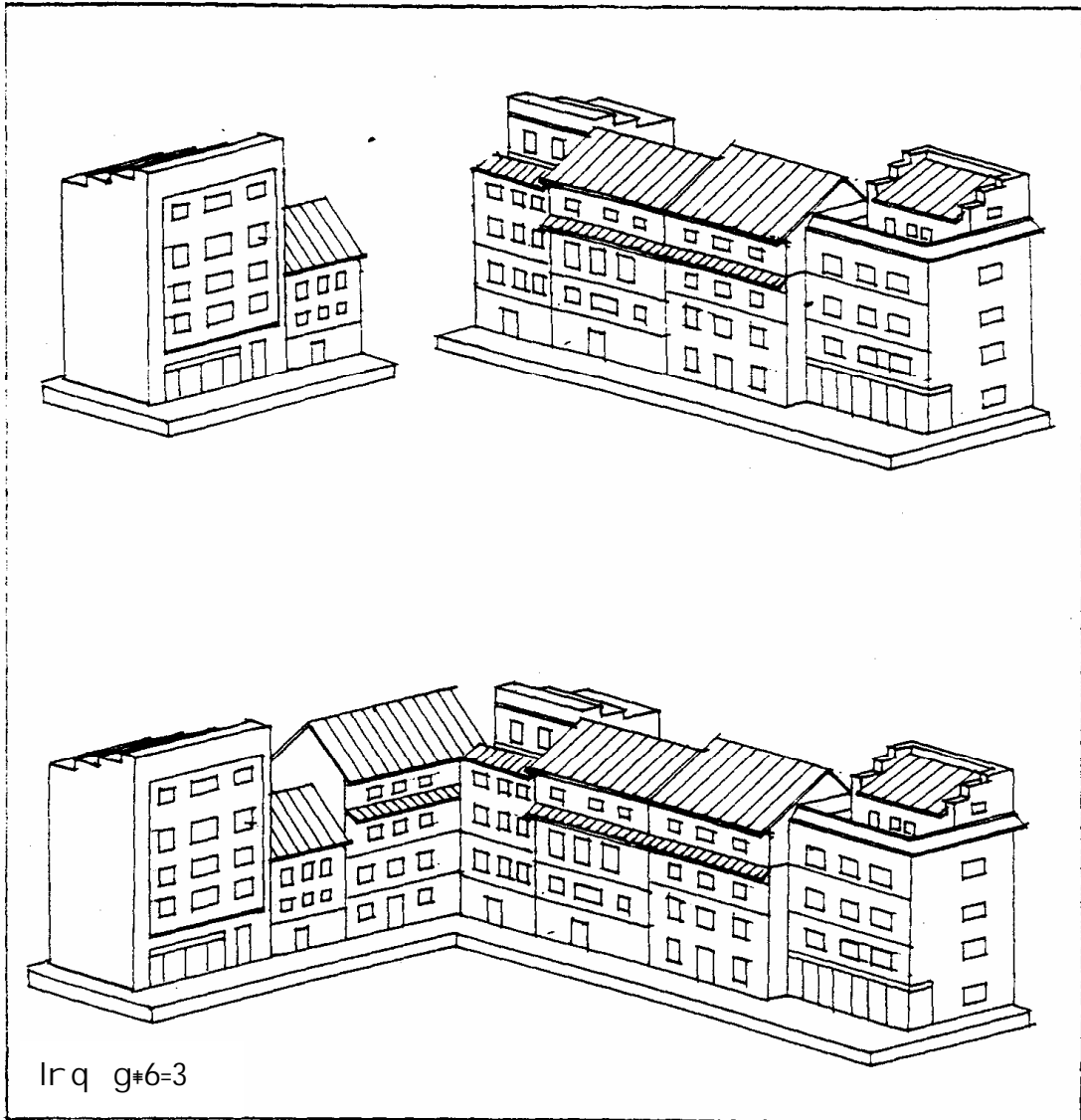

lraq g#6-3

ej gsf] tNnf ; Vof

lgodfj nLM

gllh ej gx?M

-s_ rf/ tNn]ej gsf]nflu !)=& ld6/ -#% lkm6_ ; A|ft :df/s pklfqdf agf0g].

-v_ % tNn]ej gsf]nflu !#=& ld6/ -\$\$% lkm6_ ; A|f0f pklfqdf agf0g].

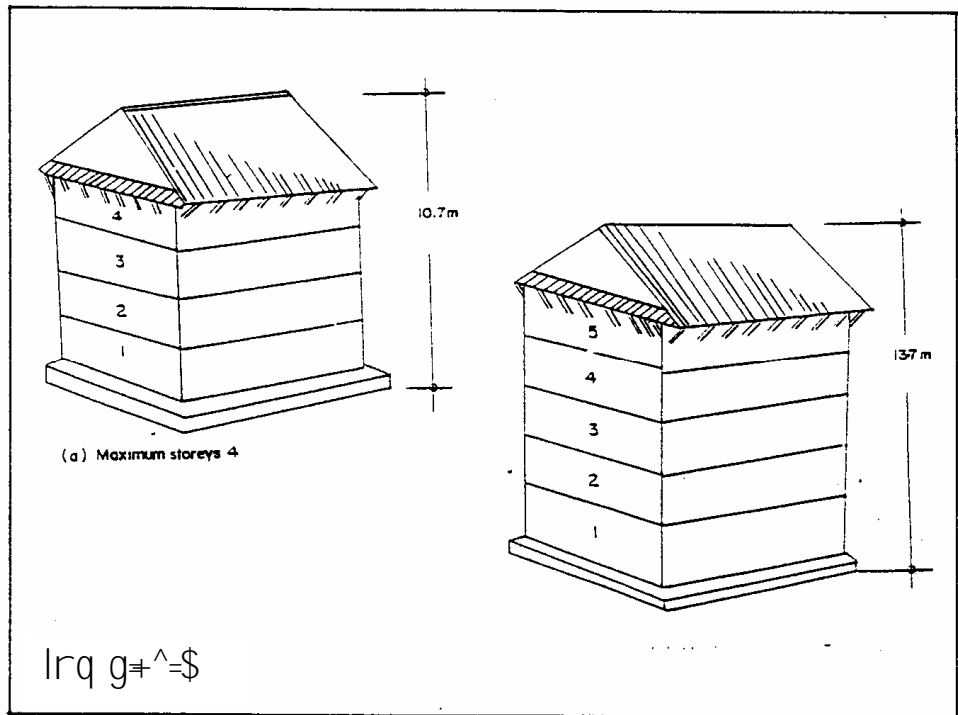

ej gsf]clwstd prf0{

lgodfj nLM

; fj hlgs ej gM ; Aift :df/s pkIfq / ; Aifof pkIfqdf agfpg kfpg]

; fj hlgs ej gsf]gdqf

-s_ !)=& dl= - #%]-# tNn]ej gsf]nflu

-v_ !#=& dl= - \$%]-\$ tNn]ej gsf]nflu

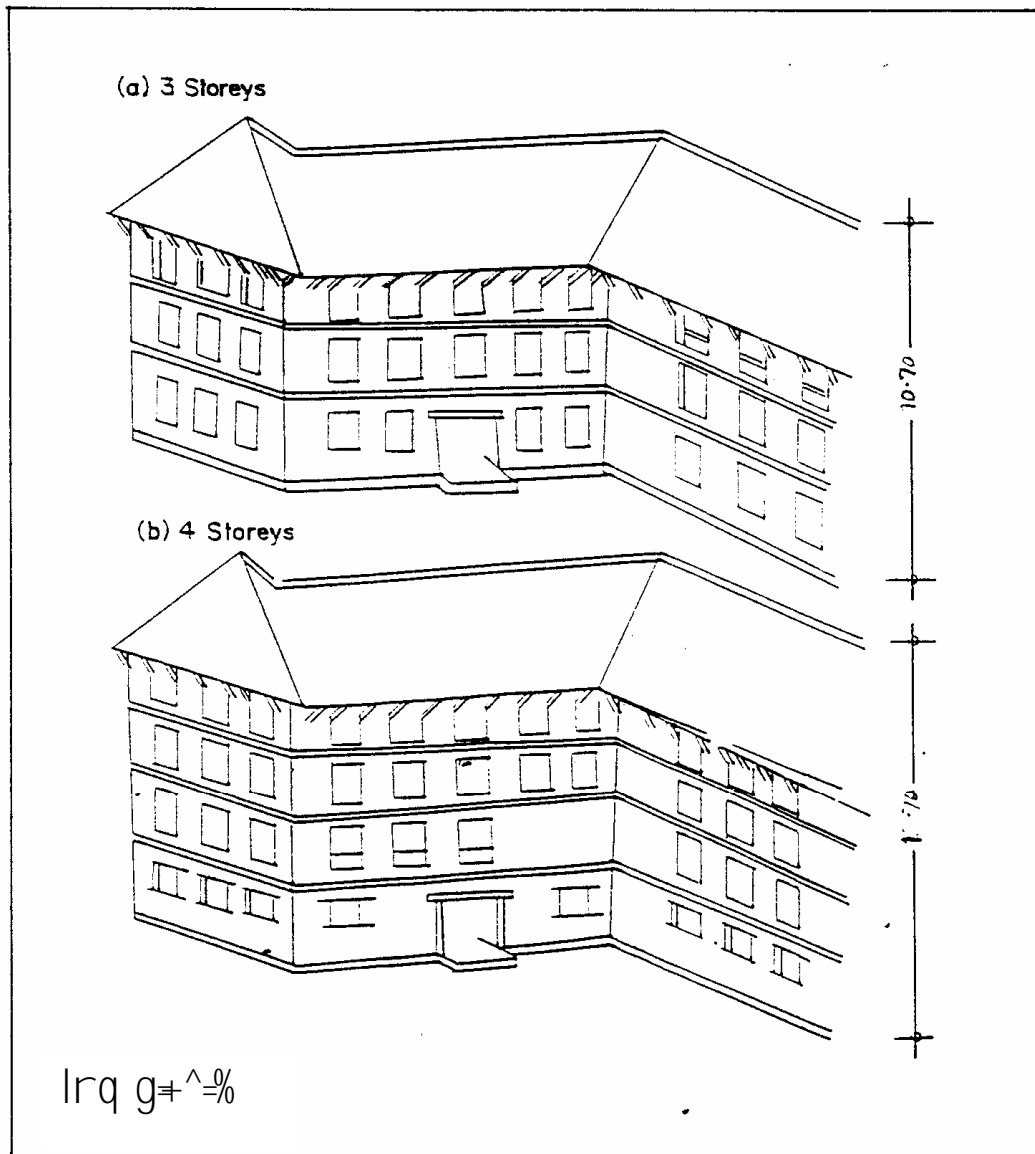

ejgsf]clwstd prf0{

lgodfj nl

prf0{ e0{ tNnfsf] (f]sf cufl*s]f] hUufsf] tof/ ePsf] ; tx b]v
gfikg]%. le/fnf] hUufdf lgdf]f u/]sf #/x?sf xsdf prf0{ ; j eGbf
tNnf] tNnfsf] (f]sf cufl*s]f] hUufsf] tof/L ePsf] ; tx b]v gfikg] %

le/fnf]sf] #/

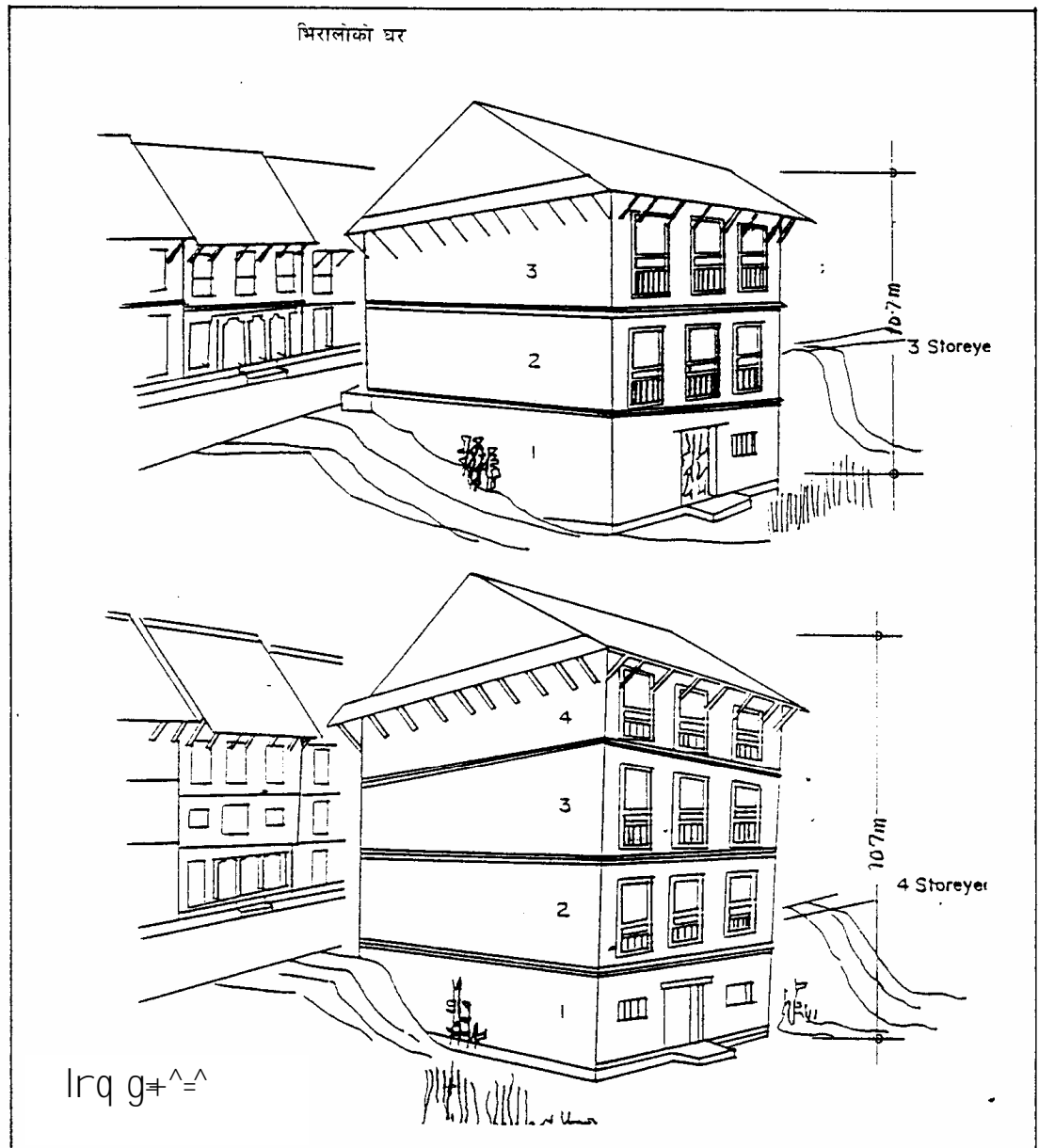

k/Dk/fut gkfnl zhlslf ej gx?sf]sxl gdgfx?

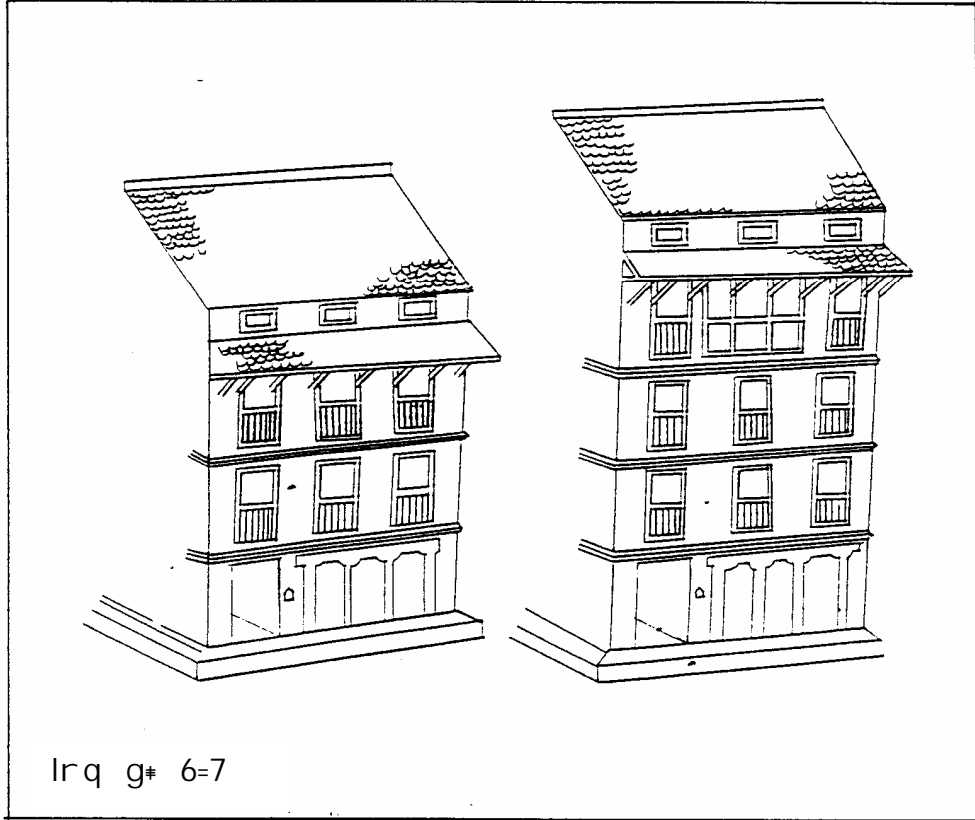

Irq g# 6=7

3/sf]dfx8f

Igodfj nl

Ighl 3/sf]dfx8fdf Igdg rlx? :ki6 xgk5{.

-s_ 3/sf]kϕL

-v_ sfgI

-u_ anϕL kvf j f 5fgfsf]kvf

AofVofM

-s_ 3/sf]kϕL -Pkϕ_

3/sf]kϕLsf]gfk I5dϕsf]3/sf kϕL; # ldnϕf]xgk5{.

kϕLsf]Gogtd prf0{! km6 xgk5{/ Gogtd rfϕf0{@ lkm6 -)=^)

ld_ xgk5{. 3/sf]kϕL ; fj hlgS hluf -; 8sdf agfpg xϕϕ_ .

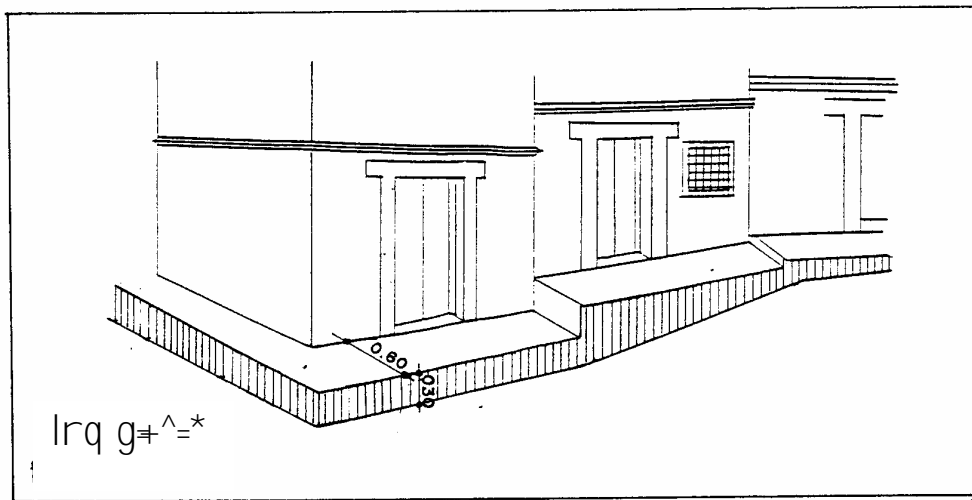

3/sf]df]8f

JofVof

-v_ sfg] M

sfg] tnsf]lrqdf b]yfPem}; Dej eP ; Dd x/§ tNnf 5l\$g] u/L /fd/]L b]vg] xgk5{.

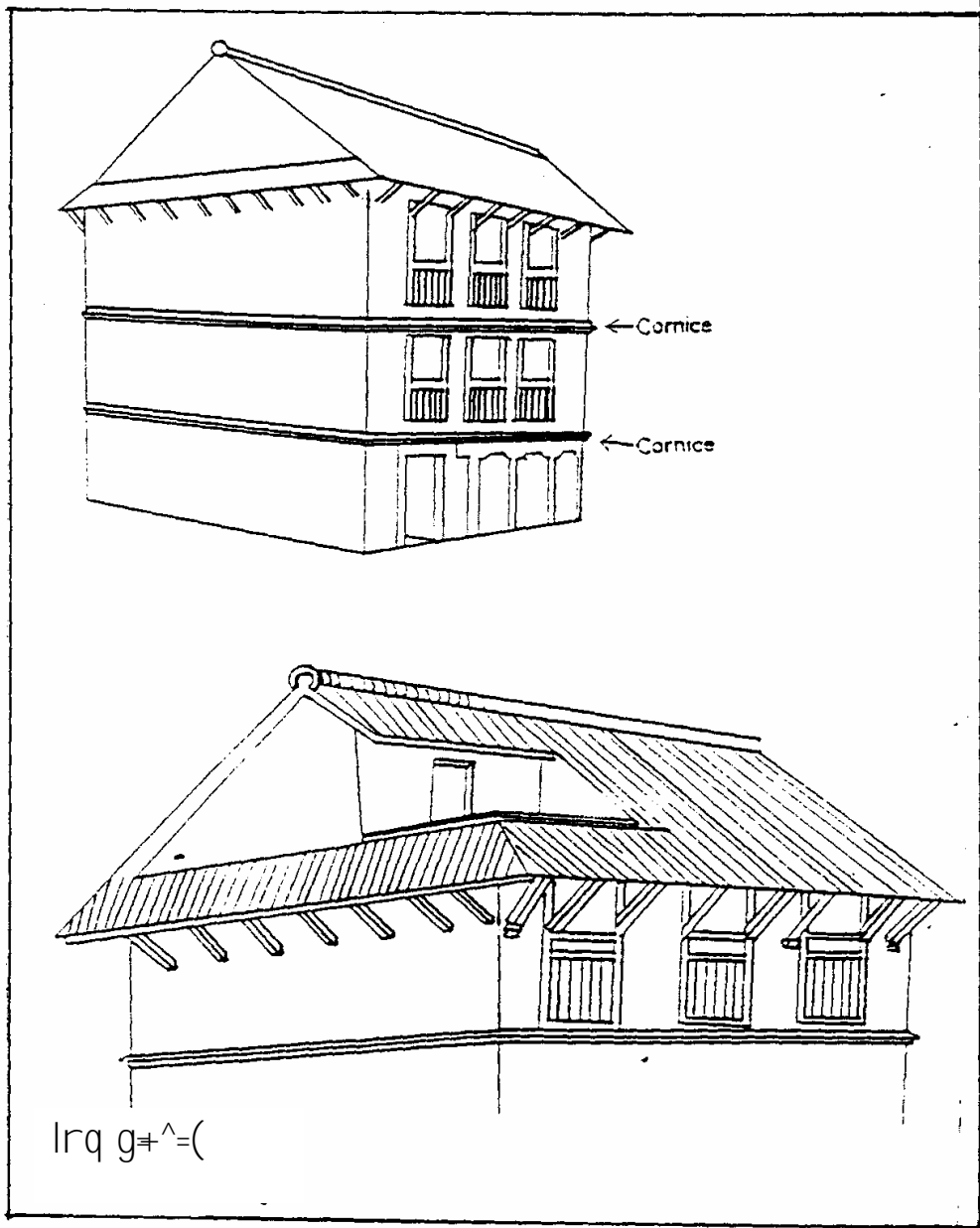

kof] ul/g]lgdf0f ; fdu]M

Igodfj nLM

; fj hlgS :ynaf6 b]vg] ; a} dfx8fsf] ufx]df 06f b]vg] xgk5{ .
dfx8fdf /flvg]a\$fx? :yfglo z]hl; # ldNg]xgk5{.

AofVofM

:yfglo z]hl eGgn]lgDg s/fx? hgfp5gM

-s_ b]vg]06fsf] ufx]df 06f tyf sf7sf a\$fx?, 3/sf]k0L, sfgI ,
andl kfvf tyf lem#6L kfvf, sf7sf 808L ePsf nfdf 7f8f
emdfnx? :yfglo z]hlsf]cfs]t xg\

-v_ b]vg]06fsf] ufx]df /# /f]ug ug{x5g .

-u_ sg}lsl; dsf]knfi6/ ug{klg :jLst ul/g]5g .

-3_ emdfn tyf 9f\$fsf]rf/]t/ wld\$ lraq0fsf]k0fhgsf]nflu dfq
knfi6/ ug{; lsg]5 .

-a_ knfi6/ rg, ; sl\$]/ ; f]df rg 3f0\$]xgkg5 .

-r_ ef/tlo z]hlsf a\$bf/ kmfd] ullnx?, a\$bf/ knfi6/, a\$bf/
ss0sf 5fgfsf /lnEx?sf]k0f] ug{cgdl t lb0g]5g .

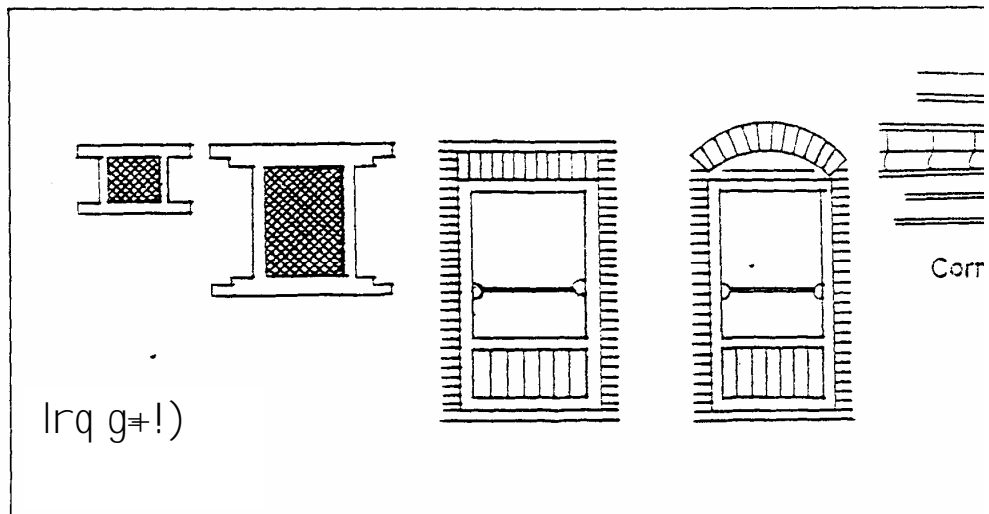

3/sf]k0L

Igodfj nLM

ej gsf]dVo dfx8fdf bf0f j f0fsf]k0L; # ldNg]u/L cfkn]f]hllufdf
k0L /fVg' kg5 .

AofVofM

- s_ ; fB'/f]uNnldf tyf bf0f j f0fsf 3/x? k0L gePsf ePdf gofFej g k0L g/fvL agfpg ; lsg]5 .
- v_ k0L bf0f j f0fsf 3/x?sf k0Lsf]nx/; # ldn\$]xgk5{.
- u_ gofFa; f]f; If0df k0Lsf]prf0{sd; \$d ! lkm6 -)=#) dl_ / rf0f0{@ lkm6 -)^) dl_ xgk5{.
- 3_ 3/df hfg]v8lsnfx? k0L leq lghl hlufdf agfpg'k5{. lghl v8lsnfxsf nflu ; fj hlgS hluf k0f]u ug{l00g]5g .

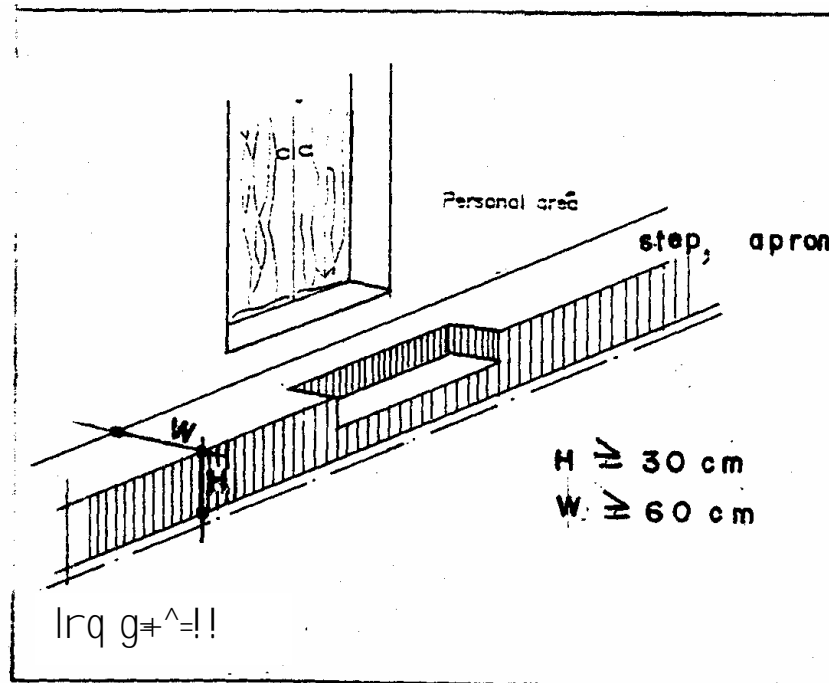

5fgf

lgodfj nLM

@=! 5fgfsf]cfsf/M

5fgf ; a}b0{kfv]xgkg5 . lj z]f kl/l:yltdf dfq Pskfv]5fgf /fVg cgdlt lb0g]5 .

AofVof

5fgfsf] le/fnf] -:nfk_ @%) eGbf sd xgx5g . lj Bdfg k/Dk/fut
z)hlsf] kvvfsf] cfwf/df / ej gnf0{kfglaf6 arfj 6 ug{cfj Zostf
x/l 5fgfsf]kvvfsf]le/fnf]lgwf{0f ul/Psf]5 .

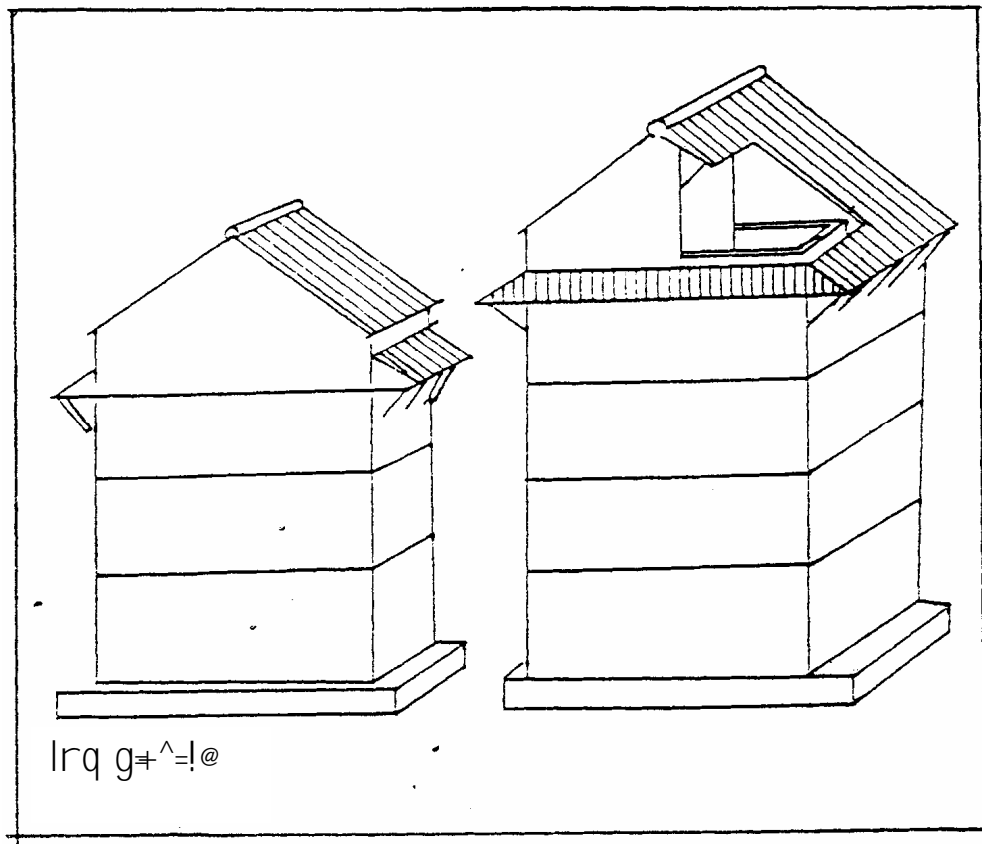

5fgf

AofVofM

Pskfv]5fgfnf0{lgDg cj :yfdf cgdlt lb0g]5 .
-s_ b0kfv]5fgf agfpg ; Dej gePdf .

-v_ vfnl hlufsf] tlg}lt/ ljlefg 3/ wglstf ej gx?n] 3}sf] ePdf tnsf] lrgdf
byfP em]Pskfv]5fgf agfpg cgdlt lb0g]5 .

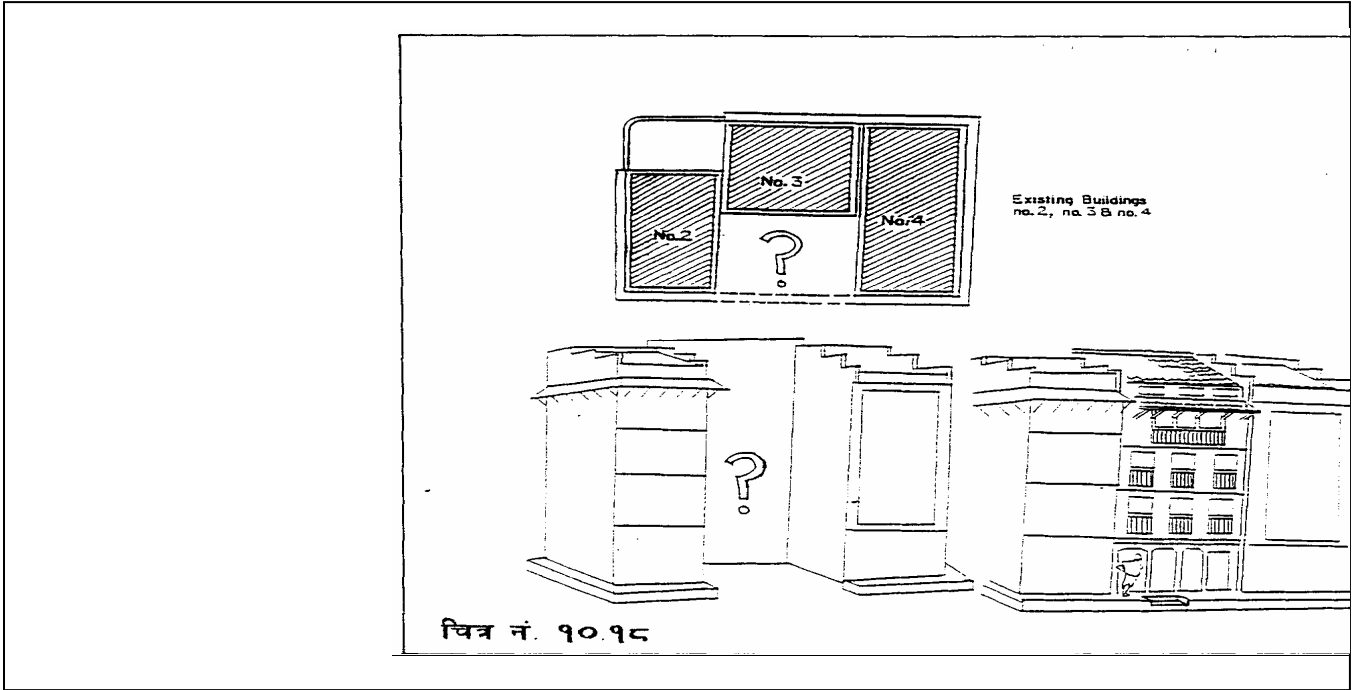

lrg g^=!#

lrg g^=!#

5fgfdf kofu ul/g]; fdfu

lgodfj nl

; Aift :df/s pklf / ; Af0f pklf leqsf / ahf/sf lqsf 3/sf
5fgf 6fon cyj f leu6lsf] xg' kg . ; fwf/0ftof c? 7f0df klg
; xl cg?k kg . c? ; fdfgsf] kofu ug{l j z}f kl/l:yltdf dfq
cgdlit lb0g .

AofVof

6fon tyf leu6L h:tf k/Dk/fut 5fgf 5fpg]; fdu[n] klitlj lDj t
k/fgf] zx/L lqsf] clalto zfnf0{ ; /ift /Vg] x]h] :ki6tof
b]vg] :yfgx?df 5fgf 5f0bf 6fon tyf leu6L afx\$ cGo sg}
; fdu] kofu ug{lb0g]5g} .

; Aift :df/s pklf tyf ; Af0f pklf leq sg}xfntdf klg 6fon j f
leu6L afx\$ c? 5fgf 5fpg]; fdu] kofu ug{cgdlit lb0g]5g} .

5fgfsf]kfvf

Igodfj nLM

5fgfsf] kvfv sDtldf)=() dl6/ -# lkm6_ sf] xgkg\$. ; f] 5fgfsf] kvfv cfkm]f] hllufdf xgkg\$. bf6f j f6fsf] kvfv; # ldNg] u/L agfpg' kg\$.

AofVofM

5fgfsf] kvfv dVo 5fgfsf] kvfv j f an9L kvfv dfq xg\$. an9L kvfv t}f] tNnf dfly l; lnE dfly xg\$. kvfv ; w}l; lnE ; txaf6 z? xG5 . of] lgodfj nl tn lb0Psf lraqdf b}yf0Psf em} \$ tNn] ej gx? ; j \$f] nflu nfu" xG5 .

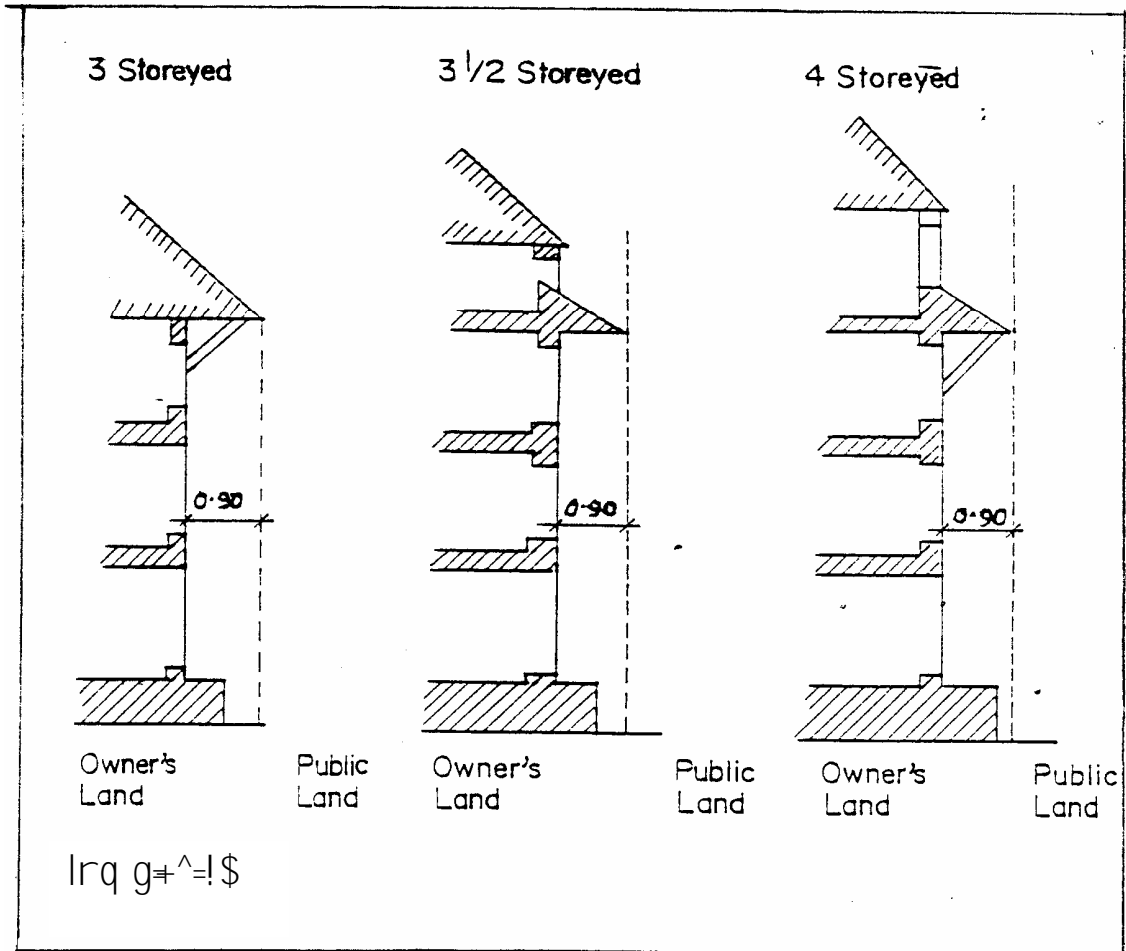

5fgfsf]sf}L

lgodfj nl

sf}Lsf]lfqkmn 5fgfsf]# v08sf]! v08 eGbf a9L xg' x5g . ; fj flgs hUuf 5ff]g]u/L sf}L lgsfNg lb0g]5g .

AofVofM

; fj flgs :yfg jf l5d\$lx?sf] hUufdf lg:sg] u/L sf}L lgsfNg lb0g] 5g . s\$6sf]a\$6f/ /lnE ePsf d08f 5fgfx? agfpg cgdlt lb0g]5g . gS; fdf b]vfP em+le/fnf] k/\$f] 5fgfdf ldnfP/ /flvg] sf}L g}k/fgf] zx/sf]nflu pkoQm 7fg\$]9fFf xg\ . sg}xfntdf klq sf}Lsf]lfqkmn ; Dk0f{tNnfsf]lfqkmnsf] ÷# v08 eGbf a9L xg' x5g .

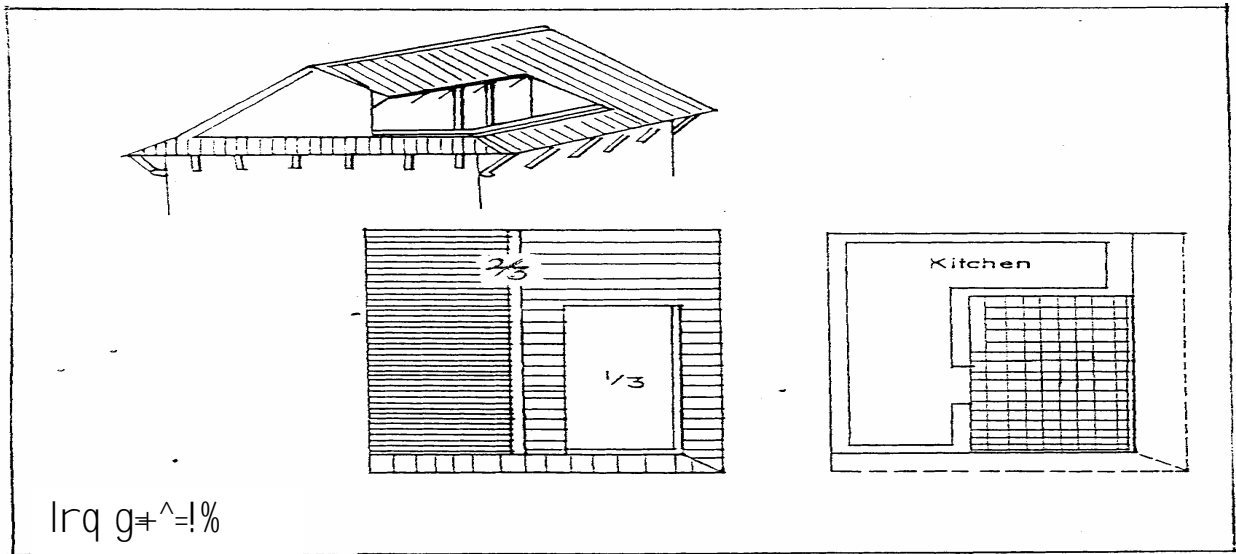

emofnx?

Igodfj nLM

emofnsf] cfsf/M

emofnsf] ; f0h / cfsf/ :yfglo z}nl; u ldNgj u/L /fVg" kg% .

AofVof

- s_ k/Dk/fut z}nlsf ; a} lsl; dsf slbPsf emofnx? agfpg lb0g5 .
- v_ k/Dk/fut cfsf/sf emofnx? ju\$sf/ cyjf cfotsf/ x65g\ . ju\$sf/ emofnx? #U±#U eGb f a9L xg' x5g . cfotsf/ emofnx? neu #U-) rf8f0{/ %U-) prf0\$]xgkg5 . rf8f0{/ prf0{cgkft !M eGb f a9L xg' x5g .
- u_ cgdlt lb0g]emofnsf ; f0hx?

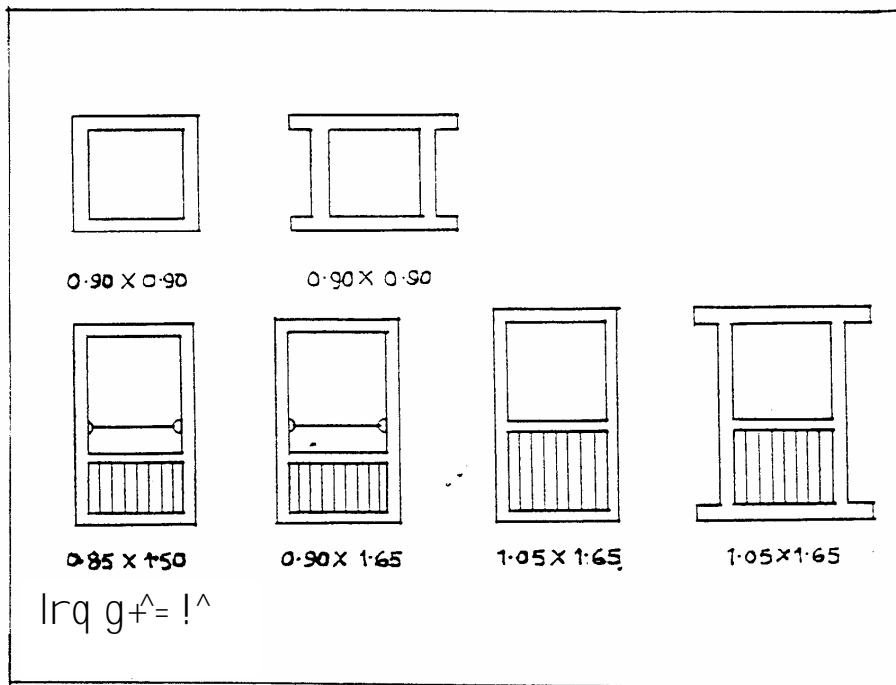

AofVofM

tnsf, lrqdf blyfPen)endfnx? tlg -#_, kfF -%_ jf ; ft -&_ sf ; dxdf ldnfP/ klg /fvG ; lsg]5 .

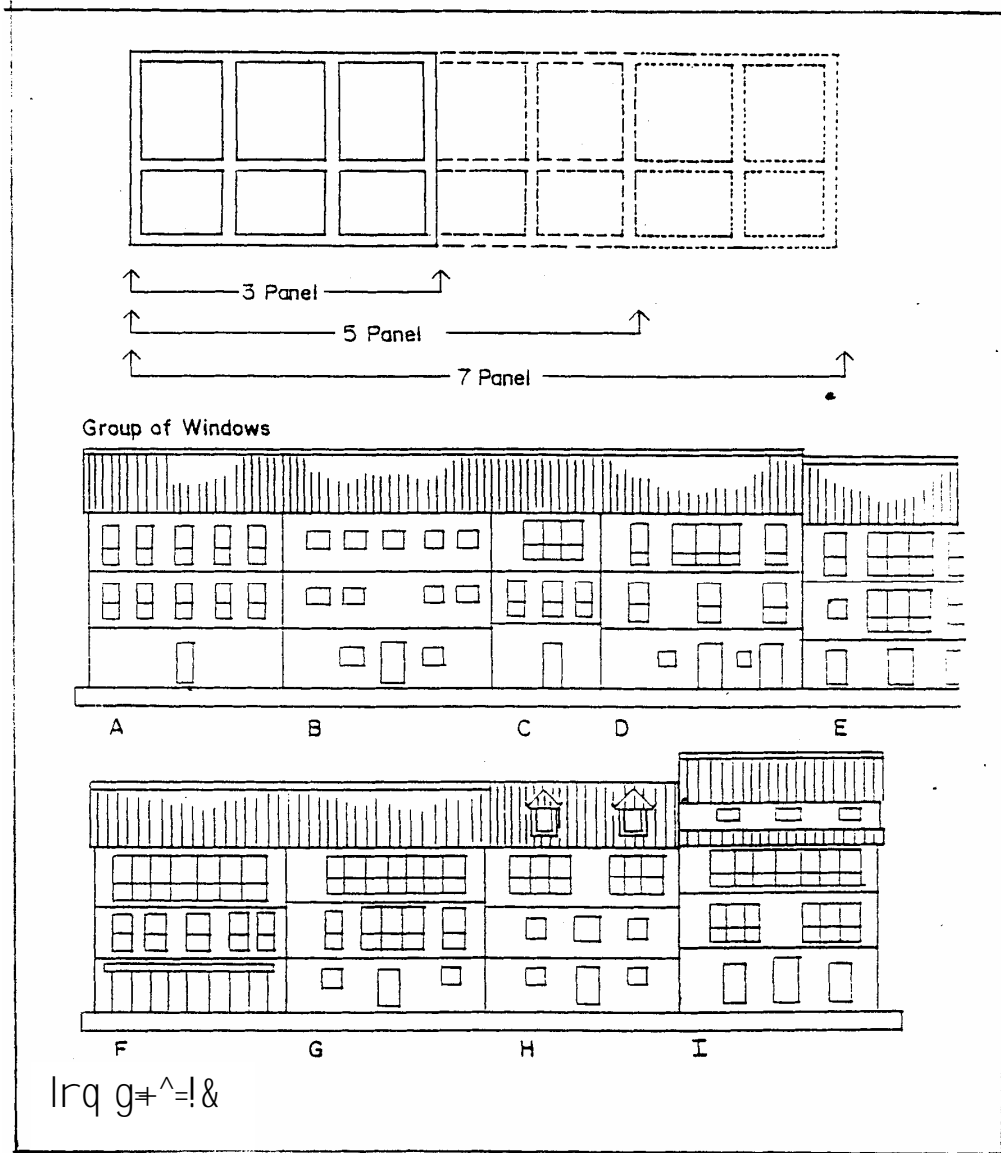

j fbñl

lgodfj nLM

j fbñl /fVg]7fð M

; fj ðlgs :ynaf6 blvg]7fðdf cyjf ; femf rfðdf j fbñl t}f] tNnfd
dfq /fVg lb0g]5 . j fbñl cf^g}hluf dfly agfpg' kgð .

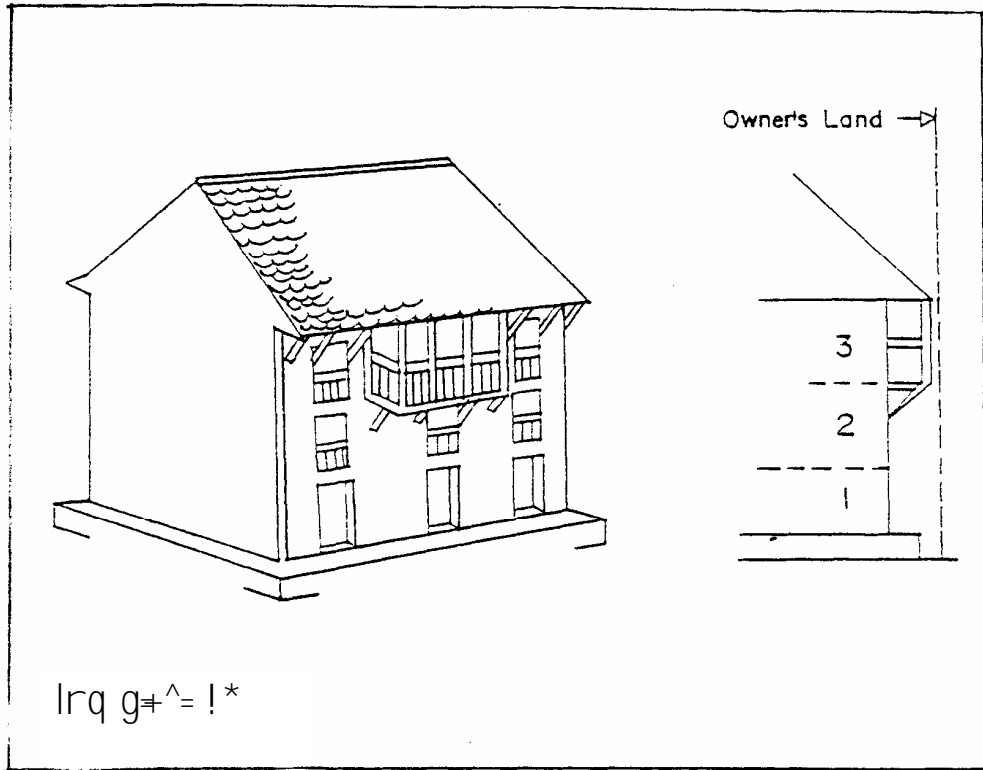

lgodfj nLM

j fb{hLsf]nDaf0M

j fb{hLsf]nDaf0{dfx8fsf]k/f nDaf0{; x/ ug{k/df l5d\$L 3/ 3glsf]d#L Ing' kg\$.

afb{hLdf kofu xg]; fdfuM

j fb{hL agfpBf sf7sf]agfpG' kg\$ / a6xf? /Vg k/df :yflgo zhl; # ldNbf]lsl; dsf] xg' kg\$. j fb{hL k/f vNnf xg' kg\$.

AofVofM

-s_ j fb{hL sf7sf]xgkg\$.

-v_ j fb{hLdf kofu ul/g]; fdulx? ; a}sf7sf]xgkg\$. h: tM vDaf, blng, km\$, 68fn tyf /InE 0Toflb .

-u_ j fb{hL dfly 5fgfn] 5f0Psf] xgkg\$ t/ sg} xfntdf klg j fb{hLnfo{emfn /fvL agb ug{cgdl t lb0g]5g} .

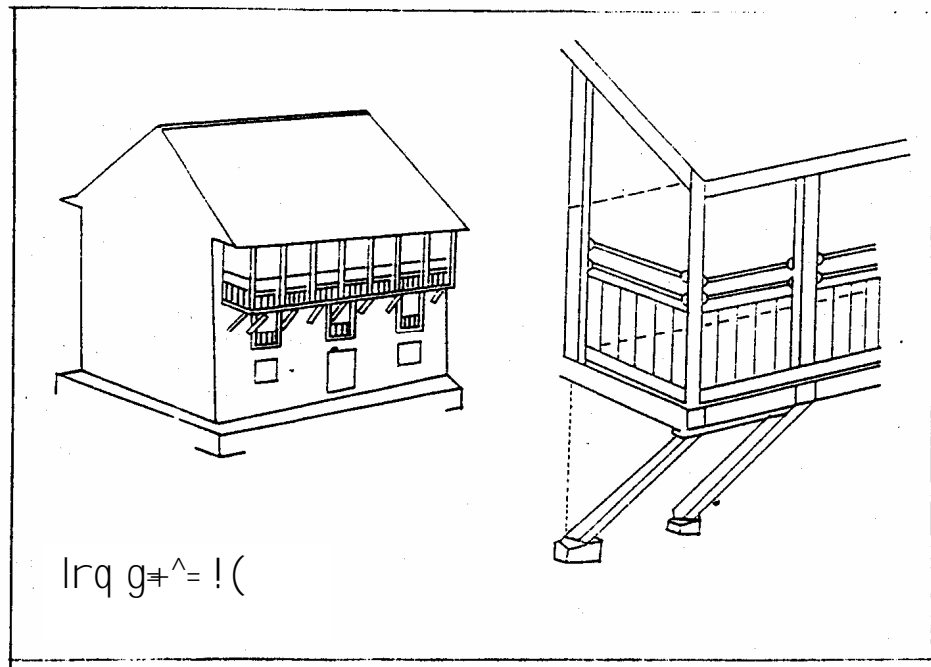

rkl{ efG5f

lgodfj nLM

-%_ rkl{

gofF3/ agfpBf rkl{sf]nflu Joj :yf ug{cfj Zos 5 .

-v_ efG5f

gofF3/ agfpBf cyj f k'fgf]3/df x]km] ubf{efG5fsf]lgsf; /
wj fHg:sg]Joj :yf xgkg5 .

AofVofM

rkl\$] Joj :yf eGgn] 9n lgsf; gePsf If]df 3/ wglN] cfkm} }
; kmL 6df\$ / ; f\$lk6 agfpg' kg5 . 9n lgsf; gePsf] :yfgdf
efG5fsf] lgsf; sf] nflu klg ; fj hlgS rf\$sf] ; \$f cfkm} hUufdf
lgsf; sf] Joj :yf ldnfpg' kg5 .

l; kmf/; x?

-!_ 8dfDk kkm -lr; f]af6 arfj 6_M

lr; f] cfpg]af6 arfpg 3/sf] xj f; sf] ; txdf 8dfDk kkm ug{ kg5 .
lj leGg ; Deflj t 8dfDk kkm\$sf lsl; dx?M

-s_ kf]nlyg ; L6 /fVg]

-v_ l; dQ6 afn] fsf] 8L=kl=; L=

-u_ l; dQ6 slqm6 8L=kl=; L

-3_ 6f/ km]6 lj 5dfpg]

-a_ la6ldg kfllg]

-@_ e0{fnfaf6 xg]lfltaf6 arfpg M

x/§ tNnfsf]e0df lj zlf u/L hu tyf 5fgf dgl cf/4; 4; = lj dsf] 3/f /fVg' kg5 .

-#_ 5fgfaf6 kfgl rlxgaf6 arfpg M

5fgfaf6 kfgl rlxgaf6 arfpg] clt kfej sf/L tyf ; fwf/0f pkfo xgM-

-s_ 5fgf 5fpg]; fdu|| dgl kfllnlyg ; l6 /fVg].

-v_ 6f/ kmll6 /fVg].

-\$_ k/Dk/fut d; nfsf] kpfuaf6 Mej gnf0{ w} sfn; Dd /fdf] cj :yfdf l6sfpg ; ls65 .

l; kmf/; x?

a0{unnf0{ ; lj wfhgs tyf a9L pkoful agfpg tnsf lraqdf b\yfpem}k/Dk/fut emfnx? /fVg]l; kmf/; ul/65 .

